IMPRESSUM / IMPRINT

Herausgeber / <i>Publisher</i>	PROJAHN Präzisionswerkzeuge GmbH · 63128 Dietzenbach · www.projahn.de
Verantwortlich / <i>Responsible</i>	Daniel Schneider, Axel Lemmer
Gestaltung, Satz & Layout / <i>Design</i>	Aleksandar Agbaba, Laura Salewski
Druck / <i>Printing</i>	Druckerei Zeidler GmbH & Co. KG · Fritz-Ullmann-Straße 7 · 55252 Mainz-Kastel · www.zeidler.de
Datum / <i>Date</i>	Juli 2016

Leistungsangaben, Eigenschaften, Abbildungen, Zusammenstellungen, Abmessungen und Gewichte von Produkten können sich im Zuge der technischen Weiterentwicklung und der Anpassung an Bedürfnisse unserer Kunden ohne Verpflichtung oder vorherige Mitteilung ändern. Es besteht keine Verpflichtung bereits gelieferte Produkte entsprechend zu verändern. Die Herausnahme von Artikeln aus unserem Lieferprogramm behalten wir uns vor. Vertrieb nur über den Fachhandel. Irrtum und Druckfehler sowie Farbabweichungen vorbehalten. © 2016 PROJAHN Präzisionswerkzeuge GmbH Deutschland. Weitere Informationen erhalten Sie unter www.projahn.de

Performance specifications, features, pictures, lists, dimensions and weight of products may change in the course of technical development and adapt to our customers' needs without obligation or prior notice. There is no obligation to change earlier deliveries accordingly. The removal of items from our product range we reserve the right. Sales only through retailers. Errors and misprints, as well as color variations we reserve the right. © 2016 PROJAHN Präzisionswerkzeuge GmbH Germany. Further information you will find at www.projahn.de

Liebe Kunden und geschätzte Geschäftspartner,

unsere beiden Kataloge **Präzisionswerkzeuge** und **Handwerkzeuge** geben Ihnen auf über 500 Seiten einen schnellen und kompakten Überblick über unser Produktprogramm. In unserem Logistikzentrum in Dietzenbach sind über 10.000 verschiedene Lagerartikel sofort für Sie verfügbar.

Auch wenn der Trend zum Online-Marketing ungebrochen ist, hören wir von unseren Kunden immer wieder, dass der gedruckte Katalog einen wesentlichen Mehrwert für sie darstellt. Sowohl bei der schnellen Produktsuche als auch im individuellen Beratungsgespräch mit dem Kunden leistet das „handfeste“ Dokument wertvolle Unterstützung. Die Schnellübersicht aller Neuprodukte auf den ersten Seiten hilft hier genauso wie die Anwendungsempfehlungen und Produktvergleiche zu Beginn der einzelnen Kapitel. Am Ende des Kataloges finden Sie außerdem Artikel- und Stichwortverzeichnisse.

Im Produktbereich **Präzisionswerkzeuge** sind die neuen ROCKET Hammerbohrer besonders hervorzuheben. Das komplett neu entwickelte Design der Hartmetallplatten und die kernverstärkte Spirale bringen große Vorteile in der Anwendung und hinsichtlich der Lebensdauer. Überzeugen Sie sich ab Seite P 13 oder besser – probieren Sie den ROCKET aus!

Im Produktbereich **Handwerkzeuge** finden Sie ab Seite H 58 die vollständige Bandbreite der neuen PROFESSIONAL Industrie-Steckschlüsselkoffer mit 25 Jahren Garantie. Diese stellen die höchste Qualitätsstufe unseres umfangreichen Programms von fast 50 verschiedenen Werkzeugkoffern dar.

Wir wünschen Ihnen viel Erfolg mit Ihrem PROJAHN Werkzeug!

Ihr PROJAHN-Team

Dear customers and valued business partners,

Our two main catalogues **Precision Tools** and **Hand Tools** provide a quick and comprehensive overview of our broad product range on more than 500 pages. In total there are over 10,000 different articles immediately available for you from stock in our logistics centre in Dietzenbach.

While the trend towards online-marketing continues, our customers keep telling us that the printed catalogue constitutes a substantial added value for them. Be it for a quick product search or when advising a customer on a specific application, the tangible printed catalogue proves to be a valuable tool. The quick overview of new products on the first pages provides valuable guidance along with the recommendations for use and the product comparisons at the beginning of each chapter. At the end of the catalogue you will find article and keyword directories.

The product area **Precision Tools** features the innovative ROCKET rotary hammer drill bits which set a new benchmark in hammer drilling. Entirely redesigned carbide tips and head geometry as well as the core reinforced flute provide high durability and substantial user benefits. See for yourself on page P 13 – or better yet – put the ROCKET to the test!

The product area **Hand Tools** includes the complete range of PROFESSIONAL socket sets starting on page H 58. This new line of industrial grade tool cases comes with a 25 year warranty. It covers the highest quality level of our comprehensive offering of nearly 50 different tool cases.

We wish you every success with your PROJAHN tools!

Your PROJAHN-Team

Brand & Values
Service & Partnership
Service & Commercial Partnership
Individual Marketing Service
Immediate Delivery
Quality
Reliability
Personal Care
BMEcat
nexmart
E-Commerce
Produkte & Innovationen
Products & Innovations
Einzigartiges Produktportfolio
Zuverlässigkeit
Sofortige Lieferung
Individual Marketing Service
Personal Support
Immediate Delivery

PROJAHN Präzisionswerkzeuge GmbH

63128 Dietzenbach · Deutschland/Germany · Fon +49 (0) 60 74 / 6 96 66-66 · Fax +49 (0) 60 74 / 6 96 66-99 · verkauf@projahn.de · sales@projahn.de · www.projahn.de
KOSTENLOSE/FREE* Fax-Hotline 0 800 / 22 44 888 *aus dem deutschen Festnetz, Handytarife können abweichen / *from the German fixed network, Mobile phone rates may vary.

Qualität – Service – Zuverlässigkeit

Quality – Service – Reliability



Nachhaltigkeit

Sustainability

PROJAHN hat eine klare Philosophie: Nachhaltigkeit und Kontinuität in der Zusammenarbeit mit Kunden, Lieferanten und Mitarbeitern. Davon profitieren alle. Denn nur durch langfristiges Engagement auf allen Ebenen findet eine starke und enge Bindung statt.

PROJAHN's philosophy: Sustainability and continuity in collaborations with customers, suppliers and employees to generate benefits for all. Only long-term commitment at all levels facilitates close and strong relationships.

Zuverlässigkeit

Reliability

Zuverlässigkeit ist die Grundlage für langfristige Partnerschaften. Genauso wie Ihr Kunde sich auf Sie verlässt, können Sie sich auf PROJAHN verlassen. Bestellungen werden sofort ausgeführt. In der Regel wird Ihre Ware am Tag Ihrer Bestellung versandt. PROJAHN-Kunden können dabei sicher sein, eine gleichbleibend hohe Qualität geliefert zu bekommen. Sie wissen, dass Sie sich auf uns verlassen können!

Reliability is the basis for long-term partnerships. Just as your customer relies on you, you can rely on PROJAHN. Orders will be processed immediately. Usually, the goods will even be dispatched on the same day you placed the order. Furthermore, PROJAHN customers can count on getting goods in a consistently high quality. You know, you can rely on us!

Kompetenz

Expertise

PROJAHN verbindet umfangreiches Produkt-Know-how in einem einzigartigen Sortiment. Für Sie als PROJAHN-Kunde heißt das: Nur die besten Produkte finden Eingang in das breite Produktportfolio für Handwerk und Industrie. Profitieren Sie von dieser Produkt-Bandbreite durch einfache Beschaffungswege bei gleichzeitig konsistenter Qualität und hoher Kompetenz.

PROJAHN combines extensive product know-how with a unique product range. As a PROJAHN customer this means for you: Only the best products will be included into our large portfolio for craft and industry. Benefit from our large product range through easy procurement routes combined with constant quality and high expertise.

Persönliche Betreuung

Personal Support

Eine starke Verbindung zwischen Kunden und Lieferanten wird besonders durch persönliche Betreuung gewährleistet. Das PROJAHN-Team steht für Kontinuität in den persönlichen Kontakten. Sie können sich auf Ihren Partner PROJAHN verlassen.

Personal support ensures a strong alliance between customer and supplier. The PROJAHN team stands for consistency in personal contacts. You know whom to turn to – be it the field staff or the office staff. And you can rely on your contact partners.

Sofortige Lieferung

Immediate Delivery

PROJAHN hält nahezu alle im Katalog aufgeführten Artikel in ausreichender Menge im Logistikzentrum in Deutschland vor. Vom kleinsten Bohrer bis zum größten Werkstattwagen. Für Sie als Kunde heißt das: Sie erhalten fast jeden Artikel aus dem umfangreichen PROJAHN-Sortiment innerhalb von 24 Stunden!

Almost all of PROJAHN's articles which are listed in the catalogue are available in stock at the logistics center in Germany: from the smallest drill bit to the largest roller cabinet. This means for you as specialized dealer: You are able to supply your customers on short notice with the requested tools, even without having high stocks of your own.

Marketingservice

Customized Marketing Support

PROJAHN bietet Ihnen mit der Marketing-Serviceabteilung professionelle Lösungen zu Fragen der Kommunikation: Der vorliegende Katalog zum Beispiel ist nach den Wünschen unserer Partner besonders übersichtlich gestaltet, damit unsere Kunden das finden, was Sie benötigen!

PROJAHN's Marketing Support Department offers you professional communication and marketing: e.g. the new catalogue – which you just hold in your hands – is designed and optimized for ease of use correspond to the feedback of our partners. So our customers don't spend long time to search – they easily find what they need.

Innovationen

Innovations

PROJAHN verfügt über ein großes Kunden- und Lieferantennetzwerk. Die tägliche Arbeit führt häufig zu neuen und besseren Ideen, um innovative Lösungen zu entwickeln. Gemeinsam mit unseren Partnern entstehen daraus professionelle Werkzeuge, die die Arbeit erleichtern, effizienter und effektiver machen.

PROJAHN maintains an extensive customer and supplier network. Daily work often inspires us with new and better ideas, to come up with innovative product solutions. In cooperation with suppliers, we use these ideas to develop professional tools that make daily work easier increasing performance as well as effectiveness.

Qualität

Quality

PROJAHN beliefert professionelle Partner, deren Kundschaft aus Handwerk, Industrie und Gewerbe kommt. Der Qualitätsanspruch unserer Kunden ist hoch. Bei täglichem Einsatz müssen die Werkzeuge wertbeständig sein und stabil funktionieren. Nur mit guten Werkzeugen kann gute Arbeit geleistet werden. Wir liefern professionelle Qualität für professionelle Anwender. Dafür steht PROJAHN.

PROJAHN supplies professional partners from craft, industry and commerce. Our customers ask for high-quality tools. In daily use, tools have to be durable and function reliably. Because only good tools enable you to do a good job! Hence, we offer professional quality for professional users. That is what PROJAHN stands for.

Einzigtiges Produktportfolio

Sales-boosting Product Portfolio

Handwerkzeuge und Präzisionswerkzeuge werden täglich von jedem Handwerker und in der Industrie benötigt. PROJAHN bietet ein sowohl breites als auch tiefes Sortiment in beiden Bereichen, wie kein anderer Anbieter. Profitieren Sie von Synergien und optimierten Beschaffungswegen. Überzeugen Sie sich von der Leistungsfähigkeit eines einzigartigen Produktsortiments.

Hand and precision tools are used by craftsman and in industrial processes on a daily basis. Like no other provider, PROJAHN offers you a broad as well as deep product range out of both product fields. Benefit from synergies and optimized procurement routes. Convince yourself of the efficiency of our unique product range.

Qualität – Service – Zuverlässigkeit

Quality – Service – Reliability



Nachhaltigkeit Experience
Image Tradition
Kundennähe **Sustainability**
Individuality **Qualität** Erscheinungsbild **Flexibilität**
Confidence **Zuverlässigkeit**
Kompetenz Reliability
Expertise Vertrauen Quality Customer Focus Erfahrung **Individualität**
Tradition

MARKE & WERTE
BRAND & VALUES

SERVICE & PARTNERSCHAFT
SERVICE & COMMERCIAL PARTNERSHIP

Professionelle Beratung
Flexibilität Customer Relationship **Persönliche Betreuung** Personal Support
Produkterschulungen Online-Competence E-Commerce
Lieferung zum **E-Commerce** Online-Kompetenz Delivery on Customer Request **nexmart**
Wunschtermin **POS-Material** **Sofortige Lieferung**
BME cat **Immediate Delivery** Beziehungsmanagement **BME cat**
Flexibilität **Individueller Marketingservice** **24/7 Service**
Professional Support **Immer erreichbar** Customized Marketing Support
Product Training **POS-Material**

Produktweiterentwicklung **Neuheiten**
Innovationen New Products
Exklusivität **Innovations** Deep Range of Products
Know-how **Einzigartiges Produktportfolio** Quality Management **Exklusivness**
Continuous Product Development Featured Articles
Sortimentsbreite **Qualität** Sales-boosting Product Portfolio
Sortimentstiefe **Know-how** Large Product Range
Quality

PRODUKTE & INNOVATIONEN
PRODUCTS & INNOVATIONS





Profi-Qualität

Professional Quality

- ▶ **Höchstes Qualitätsniveau für anspruchsvolle Anwender**
- ▶ **Präzision und Belastbarkeit weit über DIN-/ISO-Normen**
- ▶ **Ergonomisch optimiertes Kofferdesign – 2K-Koffergriff und klar strukturierte Anordnung der Werkzeuge**
- ▶ **Optimiert auf Langlebigkeit für höchste Ansprüche**
- ▶ *Highest level of quality for demanding users*
- ▶ *Precision and durability far beyond DIN/ISO standards*
- ▶ *Ergonomically optimized design – 2K-handle and clearly structured arrangement of the tools*
- ▶ *Optimized for durability for highest demands*

Einzigartiges Produktportfolio

Unique Product Range

- ▶ **Breites Produktsortiment für verschiedenste Anwendungen**
- ▶ **14 professionelle Werkzeugkoffer optimiert für individuelle Ansprüche**
- ▶ **Innovative, zukunftsorientierte Werkzeugzusammenstellung**
- ▶ *Wide product range enables universal use*
- ▶ *14 professional tool sets optimized for individual requirements*
- ▶ *Innovative and future-oriented assortment of tools*

Exklusive Persönlichkeit

Exclusive Personality

- ▶ **Hochwertige, ausdrucksstarke Premium-Optik**
- ▶ **Langlebige und stabile Design-Metallverschlüsse**
- ▶ **Werkzeuge passgenau eingebettet in Schaumeinlagen mit attraktiver metallischer Oberflächenoptik**
- ▶ *High-quality, expressive premium-look*
- ▶ *Durable and stable design metal locks*
- ▶ *Tools perfectly embedded in foam insert with attractive metallic surface appearance*

Leistungsstarker Service

Powerful Support

- ▶ **PROJAHN Qualitätsversprechen – 25 Jahre Garantie¹**
- ▶ **Alle Einzelteile problemlos nachbestellbar**
- ▶ **Inklusive Servicezertifikat**
- ▶ **Qualifizierte Produktberatung**
- ▶ *PROJAHN's promise of quality – 25 years warranty¹*
- ▶ *All individual parts easily orderable*
- ▶ *Including certificate of service*
- ▶ *Qualified product advice*

¹ Entsprechend unserer allgemeinen Garantiebedingungen
⁴ According to our general warranty conditions





Ergonomisches Design

Ergonomic Design

- ▶ **Sicherer Halt und ermüdungsfreies Arbeiten durch ergonomisch an die Hand angepasste Griffform**
- ▶ **2-Komponentenmaterial – bruchsicherer, stabiler Kern und griffige Ummantelung mit hoher Rutschhemmung**
- ▶ **Hoher Abgleitschutz durch spezielle Daumenmulden**
- ▶ **Geringere Belastung für Gelenke bei gleichzeitig höherem Drehmoment**
- ▶ **Leichte Einhandbedienung durch Schnelllöseknopf und Richtungsumschalter**
- ▶ *Secure grip and fatigue-free working due to ergonomically to the hand designed ratchet handle*
- ▶ *Two-component material – robust core combined with an ergonomic, slip-resistant surface*
- ▶ *High slip protection due to specially adapted thumb grips*
- ▶ *Less strain on joints combined with a higher torque*
- ▶ *Easy one-handed operation because of quick-release button and direction lever*

EINGETRAGENES DESIGN

REGISTERED DESIGN



Profi-Qualität

Professional Quality

- ▶ **Höchstes Qualitätsniveau für anspruchsvolle Anwender**
- ▶ **Präzision und Belastbarkeit weit über DIN-/ISO-Normen**
- ▶ **Hält extremen Drehmomenten bis 650 Nm stand²**
- ▶ **Leichtgängiger, hochpräziser Knarrenmechanismus**
- ▶ **Hohe Öl- und Säurebeständigkeit**
- ▶ *Highest level of quality for demanding users*
- ▶ *Precision and durability far beyond DIN/ISO standards*
- ▶ *Withstands extreme torques up to 650 Nm⁽²⁾*
- ▶ *Smooth-running, high-precision ratchet mechanism*
- ▶ *High oil and acid resistance*



Leistungsstarker Service

Powerful Support

- ▶ **PROJAHN Qualitätsversprechen – 25 Jahre Garantie¹**
- ▶ **Schneller Reparaturservice im Garantiefall**
- ▶ *PROJAHN's promise of quality – 25 years warranty¹*
- ▶ *Fast repair service during warranty time*



¹ Entsprechend unserer allgemeinen Garantiebedingungen / ¹ According to our general warranty conditions
² 1/2" PROJAHN-Umschaltknarre 39012900 / ² PROJAHN ratchet handle 39012900



PROForm-Werkzeugeinlagen

PROForm Tool Inlays

Dieses Produkt finden Sie im Katalog auf Seite **H 43**
*You find this product in the catalogue on page **H 43***

NEU/NEW

Artikel-Gruppe/*Article-Group*: 171



PROFESSIONAL Werkzeugkoffer

PROFESSIONAL Tool Case

Diese Produkte finden Sie im Katalog auf den Seiten **H 60 - H 73**
*You find these products in the catalogue on pages **H 60 - H 73***

NEU/NEW

Artikel-Gruppe/*Article-Group*: 110



PROJAHN Umschaltknarren

PROJAHN Ratchets

Diese Produkte finden Sie im Katalog auf den Seiten **H 93**
*You find these products in the catalogue on pages **H 93***

NEU/NEW

Artikel-Gruppe/*Article-Group*: 120



KOMBI Bit-Box

Bit Box

Dieses Produkt finden Sie im Katalog auf Seite **H 173**
*You find this product in the catalogue on page **H 173***

NEU/NEW

Artikel-Gruppe/*Article-Group*: 131



TORSION Color Bit-Box

TORSION Color Bit Box

Dieses Produkt finden Sie im Katalog auf Seite **H 175**
*You find this product in the catalogue on page **H 175***

NEU/NEW

Artikel-Gruppe/*Article-Group*: 132



Quergriff Schraubendreher-Set

T-Handle Screwdriver Set

Dieses Produkt finden Sie im Katalog auf Seite **H 195**
*You find this product in the catalogue on page **H 195***

NEU/NEW

Artikel-Gruppe/*Article-Group*: 140



TURBALL® Winkelstiftschlüssel-Set

TURBALL® Ball Point Hex Key Set

Dieses Produkt finden Sie im Katalog auf Seite **H 200**
You find this product in the catalogue on page **H 200**

NEU/NEW

Artikel-Gruppe/Article-Group: 141



PROLUMAX Power LED-Universal-Spotlight

PROLUMAX Power LED Universal Spotlight

Dieses Produkt finden Sie im Katalog auf Seite **H 219**
You find this product in the catalogue on page **H 219**

NEU/NEW

Artikel-Gruppe/Article-Group: 184



PROLUMAX Power LED-Werkstattlampe

PROLUMAX Power LED Workshop Lamp

Dieses Produkt finden Sie im Katalog auf Seite **H 220**
You find this product in the catalogue on page **H 220**

NEU/NEW

Artikel-Gruppe/Article-Group: 184



PROFI Stemmeisen-/Stechbeitel-Sets

Professional Wood Chisel Sets

Diese Produkte finden Sie im Katalog auf Seite **H 222**
You find these products in the catalogue on page **H 222**

NEU/NEW

Artikel-Gruppe/Article-Group: 182



90° Winkel-Bohradapter

90° Drill Adapter

Dieses Produkt finden Sie im Katalog auf Seite **H 234**
You find this product in the catalogue on page **H 234**

NEU/NEW

Artikel-Gruppe/Article-Group: 182



TORX® Schraubenausdreher-Set

TORX® Screw Extractor Set

Dieses Produkt finden Sie im Katalog auf Seite **H 236**
You find this product in the catalogue on page **H 236**

NEU/NEW

Artikel-Gruppe/Article-Group: 182

Qualitätsabstufungen im Katalog

Quality Levels in Catalogue

Sehr geehrter Kunde, PROJAHN liefert Ihnen stets eine gleichbleibend hohe Qualität. Um Ihnen die Suche nach dem für Ihre Anforderungen optimalen Werkzeug so einfach wie möglich zu machen, finden Sie über jedem Produkt das PROJAHN-Qualitätssiegel. Folgende Qualitätsstufen gliedern zukünftig das gesamte PROJAHN-Sortiment:

Dear Customer, PROJAHN always provides you with consistently high quality. To make the search for the optimal tool for your needs as easy as possible, you find the PROJAHN Quality Seal on each product. The following grades are dividing the entire PROJAHN range:

Höchste Qualitätsstufe / Highest Quality Level:

PROFESSIONAL PLUS STANDARD

Mittlere Qualitätsstufe / Medium Quality Level:

PROFESSIONAL **PLUS** STANDARD

Standard Qualitätsstufe / Standard Quality Level:

PROFESSIONAL PLUS **STANDARD**

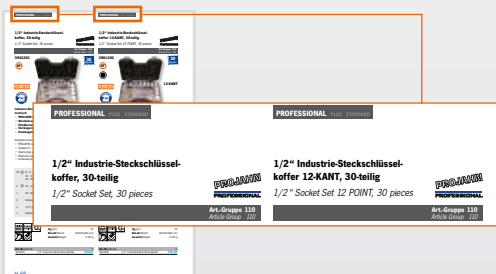

Leistung/
Performance

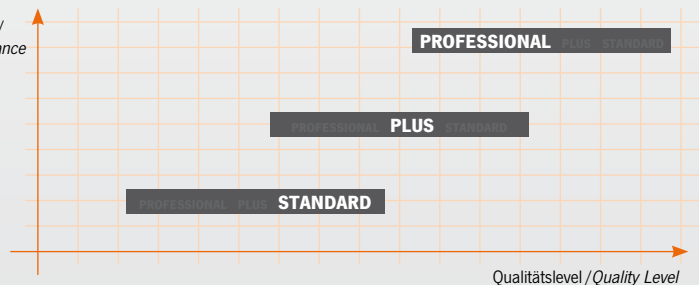

Qualitätslevel / Quality Level

PROFESSIONAL

- ▶ Höchstes Qualitätsniveau für ausgezeichnete Präzision
- ▶ Übertrifft DIN- und ISO-Normen
- ▶ Für härteste Anwendungen bei geringem Verschleiß
- ▶ Sehr lange Lebensdauer
- ▶ Hochwertigste Materialien, professionelles Oberflächen-Finish
- ▶ Kompromisslose Qualität für höchste Ansprüche

PLUS

- ▶ Sehr hohes Qualitätsniveau für präzises Arbeiten
- ▶ Qualität über DIN- und ISO-Normen
- ▶ Werkzeuge für schwierige Anforderungen
- ▶ Für problemlösungsorientierte Anwender
- ▶ Hochwertige Herstellung, ergonomisches Design

STANDARD

- ▶ Gute Markenqualität
- ▶ Sehr attraktiver Preis für Profi-Niveau
- ▶ Qualität für alle Standard-Anwendungen

PROFESSIONAL

- ▶ Highest level of quality for excellent precision
- ▶ Exceeds DIN and ISO standards
- ▶ For the hardest applications by low wear
- ▶ Very long life time
- ▶ High-quality materials, professional finish
- ▶ Uncompromising quality for highest demands

PLUS

- ▶ Very high level of quality for highest precision
- ▶ Quality higher than DIN and ISO standards
- ▶ Tools for difficult requirements
- ▶ For problem-solving users
- ▶ High-quality manufacturing, ergonomic design

STANDARD

- ▶ Good brand quality
- ▶ Attractive price-performance ratio
- ▶ Quality for all standard applications



Werkstattwagen & Zubehör

Roller Cabinets & Accessories



Sätze, Einzelteile und Drehmomentschlüssel

Socket Sets, Accessories and Torque Wrenches



Schraubenschlüssel

Wrenches



Bit-Programm

Bits



Schraubendreher & Winkelstiftschlüssel

Screwdriver & Hex Keys



Zangen

Pliers



Taschenlampen & Arbeitsleuchten

Flashlights & Working Lamps



Sonstige Werkzeuge

Other Tools



Index ab Seite H 241 / Index starting Page H 241

H 11 – H 50

H 51 – H 124

H 125 – H 152

H 153 – H 184

H 185 – H 200

H 201 – H 214

H 215 – H 220

H 221 – H 238

An diesen Zeichen erkennt man die gute PROJAHN-Qualität

You will recognize the good PROJAHN quality by these symbols

► **Produktion nach DIN ISO 9001:**

Unsere Produktionsstätten sind nach DIN ISO 9001 zertifiziert. Das ist die Basis unserer Qualitätsphilosophie.

**DIN ISO
9001**

► **Manufacture in Accordance with DIN ISO 9001:**

Our production centres are certified in accordance with DIN ISO 9001. This is the basis of our quality philosophy.

► **Stahl der höchsten Güteklasse:**

Unsere Werkzeuge werden aus qualitativ hochwertigen Chrom-Vanadium- und S2-Stählen gefertigt. Damit ist sichergestellt, dass sämtliche DIN- und ANSI-Spezifikationen weit überschritten werden.

**CHROM
VANADIUM**

► **Steel of the Highest Quality Standard:**

Our tools are manufactured from high quality Chrome Vanadium and S2 steel. This ensures, that all DIN and ANSI specifications are well exceeded.

► **Gute Werkzeuge sind für uns Ehrensache. Garantiert.**

G

► **Good tools are a matter of honor for us. Guaranteed.**

► **Alles im Griff:**

Optimale Eigenschaften des Griffes durch die Verwendung eines speziellen 'gummiartigen' Materials (TPE*). Im höchsten Maß Säure- und Ölbeständig. Dies garantiert eine lange Lebensdauer und gute Griffigkeit.



► **Everything in Your Hand:**

Optimal features of the handle due to the special 'rubber like' material (TPE) used. Resistant to acid and oil to the highest degree. This guarantees a long service life and a good grip.*

**Thermoplastic elastomer*

*Termoplastisches Elastomer

► **Auch auf den Koffer kommt es an:**

Unsere PE-Koffer sind robust und alltagstauglich. Da kann es schon mal etwas ruppiger zugehen. Unsere Koffer bleiben stabil.



► **The case matters:**

Our PE cases are robust and suitable for the working day. Things can become a bit rough sometimes. Our cases stay in shape.

► **Eingetragene Warenzeichen**

PHILLIPS®, POZIDRIV®, TRIWING®, TORQ® sind eingetragene Markenzeichen der Firma Phillips Screw Co. TORX®, TAMPER TORX® sind eingetragene Markenzeichen der Firma Camcar/Textron, Texas. XZN® ist eingetragenes Markenzeichen der Firma Bauer-Schaurte. RIBE® ist eingetragenes Markenzeichen der Firma Richard Berger. ASSY®, SIT® sind eingetragene Markenzeichen der Firma Adolf Würth GmbH. MultiFit, TOP-CLASS, PROForm, PROMobil, PROline sind eingetragene Markenzeichen der Firma PROJAHN Präzisionswerkzeuge GmbH.



► **Registered Trademarks**

PHILLIPS®, POZIDRIV®, TRIWING®, TORQ® are registered trademarks of the company Phillips Screw Co. TORX®, TAMPER TORX® are registered trademarks of the company Camcar/Textron. XZN® is a registered trademark of the company Bauer-Schaurte. RIBE® is a registered trademark of the company Richard Berger. ASSY®, SIT® are registered trademarks of the company Adolf Würth GmbH. MultiFit, TOP-CLASS, PROForm, PROMobil are registered trademarks of the company PROJAHN Präzisionswerkzeuge GmbH.

► **Größenangaben**

1/4" = 6,35 mm | 3/8" = 9,52 mm | 1/2" = 12,70 mm
3/4" = 19,05 mm | 1" = 25,40 mm



► **Sizes**

1/4" = 6,35 mm | 3/8" = 9,52 mm | 1/2" = 12,70 mm
3/4" = 19,05 mm | 1" = 25,40 mm



Alle Module aus dem Kapitel SYSTEMWAND finden Sie unter:

All System Wall Racks you find at:

www.projahn.de/qr/pos/systemwand



Alle Produkte aus dem Kapitel WERBEMITTEL finden Sie unter:

All Give-Aways you find at:

www.projahn.de/qr/werbemittel

Werkstattwagen & Zubehör

*Roller Cabinets
& Accessories*



PROJAHN Werkstattwagen und Zubehör – Qualität und Vielfalt

PROJAHN Roller Cabinets and Accessories – Quality and Variety

PROFESSIONAL PLUS STANDARD

5901, 5901-50, 5901-20

RedLine 7

SuperBlue

BlackLine

Die Profi-Werkstattwagen – Profi-Qualität im hervorragenden Preis-Leistungs-Verhältnis

Professional Roller Cabinets – Professional Quality with the best Value for Money



- ▶ **Hervorragendes PREIS-LEISTUNGS-VERHÄLTNIS:** Profi Qualität, hohe Sicherheit, Langlebigkeit und umfangreiches Zubehör
 - ▶ **LANGLEBIG und STABIL:**
Robuste Doppelwandkonstruktion mit 0,9 mm Materialstärke
 - ▶ **STRAPAZIERFÄHIG:** Hochstabile, kugelgelagerte Schubfachauszüge
 - ▶ **HOHE ARBEITSSICHERHEIT:**
Schubfächer-Sicherheits-Stopp-System (BG-konform)
 - ▶ **HOHES FASSUNGSVERMÖGEN:** 7 Schubfächer mit jeweils einer Belastbarkeit bis zu 40 kg
 - ▶ **HOCH STABIL:** Gesamtbelastbarkeit bis zu 600 kg
 - ▶ **HOHE SICHERHEIT:** Räder mit Roll- und Drehbremse
 - ▶ **STRAPAZIERFÄHIG:** Öl- und säurebeständige Rollen
 - ▶ **MULTIFUNKTIONAL:** Umfangreiches Zubehör
 - ▶ **INDIVIDUELL:** In 3 Farbkombinationen lieferbar
- ▶ *Best value for money: Professional quality, high safety and lots of accessories*
 - ▶ *Excellent stability and torsional stiffness: Double wall construction with 0,9 mm material thickness*
 - ▶ *For heavy duty: Smooth-running and durable ball bearing slides*
 - ▶ *High work-safety: Only-One-Drawer (OOD) system – only one drawer at a time be opened*
 - ▶ *High capacity: 7 drawers with a capacity of up to 40 kg each*
 - ▶ *High stability: Max. overall capacity of up to 600 kg*
 - ▶ *High safety: Rolls with full break system*
 - ▶ *Hard-wearing: Robust oil and acid-resistant castors*
 - ▶ *Multifunctional: Extensive Range of accessories available*
 - ▶ *Individual: Available in 3 colour-combinations*



Katalog-Seite / Catalogue Page
H 14

PROJAHN Werkstattwagen und Zubehör – Qualität und Vielfalt

PROJAHN Roller Cabinets and Accessories – Quality and Variety

PROFESSIONAL PLUS STANDARD

7901-50 SPACELine

Der clevere Profi-Werkstattwagen – Profi-Qualität mit cleverem Platzkonzept

The clever professional Roller Cabinet – Professional quality with a clever space concept

- ▶ **RIESIGES FASSUNGSVERMÖGEN:** 7 Schubfächer und zusätzlich 2 seitliche Türen mit diversen Staufächern
- ▶ **HOHE ARBEITSSICHERHEIT:** Schubfächer-Sicherheits-Stopp-System – nur ein Schubfach ausziehbar (BG-konform)
- ▶ **MEHR PLATZ FÜR IHRE WERKZEUGE:** Größere Arbeits- und Ablagefläche
- ▶ **ORDNUNG:** Mehr Übersichtlichkeit beim Arbeiten sowie beim Suchen von Werkzeugen
- ▶ **EXTREM STABIL:** Hohe Stabilität und Verwindungssteifigkeit
- ▶ **EINZIGARTIG und DAUERHAFT:** Öl- und säurebeständige Design-Hochglanzfelgen
- ▶ **PROFESSIONELL und ZEITLOS:** Modernes und durchdachtes Design
- ▶ **ERGONOMISCH:** Längerer Rollenabstand erleichtert das Bewegen des Wagens
- ▶ **EXTREM STABIL:** Gesamtbelastbarkeit bis 500 kg
- ▶ **HOHE SICHERHEIT:** Räder mit Roll- und Drehbremse

- ▶ *Huge capacity: 7 Drawers and additionally 2 side doors with more storage space*
- ▶ *High work-safety: Only-One-Drawer (OOD) System – only one drawer at a time may be openend*
- ▶ *More Space for your tools: Larger work & shelf space*
- ▶ *Organization: More clarity while working and when searching for tools*
- ▶ *Extremely stable: High stability and torsional stiffness*
- ▶ *Unique and durable: Sturdy oil and acid-resistant design mirror finish wheels*
- ▶ *Professional and timeless: Modern and sophisticated design*
- ▶ *Ergonomic: Wider axial distance facilitates the moving of the cabinet*
- ▶ *High stability: Total load up to 500 kg*
- ▶ *High safety: Rolls with full break system*



Katalog-Seite / Catalogue Page
H 16

PROFESSIONAL PLUS STANDARD

4901-50 ECOBlue

Der ökonomische Profi Werkstattwagen – Gute Qualität und Funktionalität zum fairen Preis!

The Economic Roller Cabinet – Good Quality and High Functionality at a Fair Price!

- ▶ **ÖKONOMISCH:** Gute Qualität, hohe Sicherheit und viele Funktionen zum fairen Preis
- ▶ **GUTE STABILITÄT:** Robuste Wandkonstruktion mit 0,8 mm Materialstärke
- ▶ **HOHE ARBEITSSICHERHEIT:** Schubfächer-Sicherheits-Stopp-System – nur ein Schubfach ausziehbar (BG-konform)
- ▶ **SOLIDE:** Stabile, kugelgelagerte Schubfachauszüge
- ▶ **ANSPRECHENDES FASSUNGSVERMÖGEN:** 6 Schubfächer mit jeweils einer Belastbarkeit bis zu 35 kg
- ▶ **FUNKTIONAL:** Umfangreiches Zubehör
- ▶ **STABIL:** Gesamtbelastbarkeit bis zu 400 kg
- ▶ **HOHE SICHERHEIT:** Räder mit Roll- und Drehbremse

- ▶ *Economic: Good quality, high safety and functionality at a fair price*
- ▶ *Good stability: Robust wall construction with 0,8 mm material thickness*
- ▶ *High work-safety: Only-One-Drawer (OOD) system – only one drawer at a time to be opened*
- ▶ *Smooth-running and durable ball bearing slides*
- ▶ *Good capacity: 6 drawers with a capacity of up to 35 kg each*
- ▶ *Functional: Accessories available*
- ▶ *High stability: Max. overall capacity of up to 400 kg*
- ▶ *High safety: Castors with full break system*



Katalog-Seite / Catalogue Page
H 18

Werkstattwagen

Roller Cabinets

RedLine 7

SuperBlue

BlackLine

Art.-Gruppe 170
Article Group 170

5901, 5901-50, 5901-20 **RedLine 7** **SuperBlue** **BlackLine**

Die Profi-Werkstattwagen – Profi-Qualität im hervorragenden Preis-Leistungs-Verhältnis

Professional Roller Cabinets – Professional Quality with the best value for money

- ▶ **Hohe Stabilität und Verwindungssteifigkeit durch Doppelwandkonstruktion**
- ▶ **Hervorragendes Preis-Leistungs-Verhältnis**
- ▶ **7 Schubfächer (5 x 75 mm , 2 x 154 mm Höhe)**
- ▶ **Leichtgängige und langlebige, kugelgelagerte Schubfächerauszüge mit sehr hoher Belastbarkeit**
- ▶ **Durch Zentral-Sicherheits-Stopp-System max. nur ein Schubfach ausziehbar (BG-konform)**
- ▶ **Schubfächer mit Vollauszug**
- ▶ **Inklusive Handgriff**
- ▶ **In den Farben Blau, Rot und Schwarz lieferbar**
- ▶ **Umfangreiches Zubehör verfügbar**
- ▶ **Zentralverriegelung durch Zylinderschloss reduziert Diebstahl von Werkzeugen**
- ▶ **Robuste, überdimensionierte öl- und säurebeständige Rollen**
- ▶ **Rollen mit Roll- und Drehbremse verhindern das Wegrollen des Werkstattwagens**
- ▶ **Jedes Schubfach kann mit bis zu 3 PROForm Werkzeugeinlagen individuell bestückt werden**



Material/Material:	Stahlblech, pulverbeschichtet/Steel plates, powder-coated
Materialstärke/Material Thickness:	0,9 mm
Konstruktion/Construction:	Doppelwandkonstruktion/Double wall construction
Farbe/Colour:	Blau, Rot, Schwarz/Blue, Red, Black
Abmessungen (HxBxT)/Dimensions (HxWxD):	1.000 x 676 x 459 mm
Belastbarkeit pro Schubfach/Max. Capacity per Drawer:	40 kg
Belastbarkeit insgesamt/Max. overall Capacity:	600 kg
Gewicht/Weight:	63 kg
Rollenabmessungen/Roll Dimensions:	Ø 127 x 50 mm

Weitere technische Details siehe Seite H 22
More technical data please find on page H 22
Zubehör siehe Seiten H 15, H 19 - H 21
Accessories please find on pages H 15, H 19 - H 21
PROForm Werkzeugeinlagen ab Seite H 32
PROForm Tool Sets find from page H 32

- ▶ *High stability and torsional stiffness*
- ▶ *Top value for money*
- ▶ *7 Drawers (5 x 75 mm, 2x 154 mm Height)*
- ▶ *Smooth-running and durable ball bearing slides with high capacity*
- ▶ *Due to Only-One-Drawer (OOD) system - only one drawer at a time may be opened*
- ▶ *Full extension of drawers*
- ▶ *Robust oil and acid-resistant castors*
- ▶ *Full Break System*
- ▶ *One handhold included*
- ▶ *Available in Blue, Red and Black*
- ▶ *Central locking system prevents against larceny of tools*
- ▶ *Extensive range of accessories available*
- ▶ *Customized assembling with up to 3 PROForm inlays*



Kugelgelagerte Schubfächerauszüge
Ball Bearing Slides



Robuste Doppelwandkonstruktion
Robust double wall construction



Öl- und säurebeständige Rollen
Oil and acid resistant castors



Umfangreiches Zubehör
Extensive range of accessories

Art.-Nr./Art.-No.	Farbe/Color
5901-50	Blau/Blue
5901	Rot/Red
5901-20	Schwarz/Black

Werkstattwagen Zubehör

Accessories for Roller Cabinets

RedLine 7
SuperBlue
BlackLine
Art.-Gruppe 173
 Article Group 173

5902, 5902-50, 5902-20
RedLine 7
SuperBlue
BlackLine

Werkzeugkoffer mit 6 Schubfächern, leer

Tool Box with 6 drawers, empty

RedLine

5902

SuperBlue

5902-50

BlackLine

5902-20

- ▶ Der ideale Aufsatz für Ihren »RedLine«, »SuperBlue« oder »BlackLine« Werkstattwagen
- ▶ Schnelle und einfache Kapazitätserweiterung vorhandener Werkstattwagen
- ▶ 3 Schubfächer mit Innenmaß 75 x 269 x 568 mm
- ▶ Weitere 3 schmale Schubfächer für Kleinteile
- ▶ Herausnehmbarer Werkzeugeinsatz im Stauraum des Deckels
- ▶ Leichtgängige und langlebige, kugelgelagerte Schubfachauszüge
- ▶ Zentralverriegelung durch Schließen des Deckels
- ▶ Abschließbar durch Zylinderschloss
- ▶ Alle Schubfächer mit Vollauszug
- ▶ Inklusive 2 stabile Handgriffe
- ▶ Speziell angepasste PROForm Werkzeugeinlagen verfügbar

Werkstattwagen »BlackLine«
und Werkzeugkoffer
Roller Cabinet »BlackLine«
and Tool Box



Material/Material:	Stahlblech, pulverbeschichtet/Steel plates, powder-coated
Materialstärke/Material Thickness:	0,9 mm
Farbe/Colour:	Blau, Rot, Schwarz/Blue, Red, Black
Abmessungen (HxBxT)/Dimensions (HxWxD):	378 x 660 x 307 mm
Belastbarkeit pro Schubfach/Max. Capacity per Drawer:	30 kg
Gewicht/Weight:	25,5 kg

- ▶ Ideal for putting on top of the »RedLine«, »SuperBlue« or »BlackLine« roller cabinet
- ▶ Fast and easy possibility to improve the capacity of your roller cabinet
- ▶ 3 Drawers with inside dimensions 75 x 269 x 568 mm
- ▶ 3 additional slim drawers for small parts
- ▶ Mobile tool set inlay inside of the case lid
- ▶ Smooth-running and durable ball bearing slides
- ▶ Locking all drawers by closing the top
- ▶ Full extension of drawers
- ▶ 2 handholds included
- ▶ Specific PROForm tool inlays available

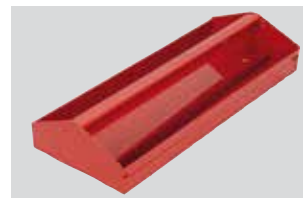

Mobiler Werkzeugeinsatz im Deckel
Removable Tool Set Inlay



Passende Werkzeugeinlagen verfügbar
Tool Inlays available



Weitere PROForm-Werkzeugeinlagen ab Seite /
More PROForm Inlays for Roller Cabinet from Page H 32

Art.-Nr./Art.-No.	Farbe/Color
5902	Rot/Red
5902-50	Blau/Blue
5902-20	Schwarz/Black

Werkstattwagen

Roller Cabinets

SPACE Line

Art.-Gruppe 170
Article Group 170

7901-50 **SPACE Line**

Der clevere Profi-Werkstattwagen – Profi-Qualität mit cleverem Platzkonzept

The clever professional Roller Cabinet – Professional quality with a clever space concept

- ▶ **Hohe Stabilität und Verwindungssteifigkeit durch Doppelwandkonstruktion**
- ▶ **Riesiges Fassungsvermögen durch 7 Schubfächer und zusätzlich 2 seitliche Türen mit diversen Staufächern**
- ▶ **7 Schubfächer (5 x 75 mm, 2 x 154 mm Höhe)**
- ▶ **Leichtgängige und langlebige, kugelgelagerte Schubfächerauszüge mit sehr hoher Belastbarkeit**
- ▶ **Durch Zentral-Sicherheits-Stopp-System max. nur ein Schubfach ausziehbar (BG-konform)**
- ▶ **Schubfächer mit Vollauszug**
- ▶ **Zentralverriegelung durch Zylinderschloss verhindert Diebstahl von Werkzeugen**
- ▶ **Alle Schubfächer und Seitentüren mit gleichem Schlüssel abschließbar**
- ▶ **Strapazierfähige, ölbeständige Design-Hochglanzräder**
- ▶ **Rollen mit Roll- und Drehbremse verhindern das Wegrollen des Werkstattwagens**
- ▶ **Inklusive Handgriff**
- ▶ **Jedes Schubfach kann mit bis zu 3 PROForm Werkzeugeinlagen individuell bestückt werden**



Anwendungsbeispiel/Example of use

Material/Material:	Stahlblech, pulverbeschichtet/Steel plates, powder-coated
Materialstärke/Material Thickness:	0,8 – 0,9 mm
Konstruktion/Construction:	Doppelwandkonstruktion/Double wall construction
Farbe/Colour:	Blau-Anthrazit/Blue-antracite
Abmessungen (HxBxT)/Dimensions (HxWxD):	990 x 910 (990 inkl. Griff) x 475 mm
Belastbarkeit pro Schubfach/Max. Capacity per Drawer:	40 kg
Belastbarkeit insgesamt/Max. overall Capacity:	500 kg
Gewicht/Weight:	72 kg
Rollenabmessungen/Roll Dimensions:	Ø 127 x 50 mm

Weitere Technische Details siehe Seite H 26
More technical data please find on page H 26

Zubehör siehe Seite H 18, H 25
Accessories please find on page H 18, H 25

PROForm Werkzeugeinlagen ab Seite H 36
PROForm Tool Sets find from page H 36

- ▶ High stability and torsional stiffness
- ▶ Hugh capacity because of 7 Drawers and additionaly 2 side doors
- ▶ 7 Drawers (5 x 75 mm, 2 x 154 mm Height)
- ▶ Smooth-running and durable ball bearing slides with high capacity
- ▶ Due to Only-One-Drawer (OOD) system – only one drawer at a time may be opened
- ▶ Full extension of drawers
- ▶ Central locking system prevents against larceny of tools
- ▶ All Drawers and side doors lockable with only one key
- ▶ Robust oil and acid-resistant design mirror finish wheels
- ▶ Full Break System
- ▶ One handle included
- ▶ Customized assembling with up to 3 PROForm inlays



Maximaler Stauraum
Maximum storage space



Gasdruckfedern zum Öffnen & Schließen
Gas pressure spring for opening & closing



Design Hochglanzfelgen
Design Mirror Finish Wheels



Kugelgelagerte Schubfächerauszüge
Ball Bearing Slides

Art.-Nr./Art.-No.	Farbe/Color
7901-50	Blau-Anthrazit/Blue-anthracite

Werkstattwagen – Zubehör und Ersatzteile

Roller Cabinets – Accessories and Spare Parts

SPACE Line

Art.-Gruppe 170
Article Group 170

SPACE Line

Ersatzrollen
Spare Castor



Art.-Nr./Art.-No.

5997-026 Bockrolle/Fixed castor
5997-027 Lenkrolle/Dirigible castor

SPACE Line

Schlösser-Set
Cylinder Lock Set

3 Schließzylinder mit je 2 Schlüsseln
3 Cylinder Locks each with 2 Keys



Art.-Nr./Art.-No.

5998-001SPACE

SPACE Line

Gasdruckfeder für Seitentür
Gas Pressure Spring for Side Door



Art.-Nr./Art.-No.

5997-029

SPACE Line

Handgriff
Handle



Art.-Nr./Art.-No.

5997-028



Werkstattwagen

Roller Cabinets

ECOBlue

Art.-Gruppe 170
Article Group 170

4901-50 **ECOBlue**

Der ökonomische Profi-Werkstattwagen – Gute Qualität und hohe Funktionalität zum fairen Preis! Werkstattwagen mit 6 Schubfächern

The economic Roller Cabinet – Good quality and high functionality at a fair price! Roller Cabinet, 6 drawers

- ▶ **Gute Stabilität und Verwindungssteifigkeit**
- ▶ **6 Schubfächer (3 x 75 mm, 3 x 154 mm Höhe)**
- ▶ **Leichtgängige, kugelgelagerte Schubfachauszüge**
- ▶ **Durch Zentral-Sicherheits-Stopp-System max. nur ein Schubfach ausziehbar (BG-konform)**
- ▶ **Zentralverriegelung durch Zylinderschloss**
- ▶ **Rollen: 2 x feststehend, 2 x lenkbar aus Kunststoff**
- ▶ **Rollen mit Roll- und Drehbremse verhindern das Wegrollen des Werkstattwagens**
- ▶ **Inklusive Handgriff zum einfachen Fortbewegen des Wagens und Kunststoffauflagematte**
- ▶ **Jedes Schubfach kann mit bis zu 3 PROForm-Werkzeugeinlagen individuell bestückt werden**



Material/Material:	Stahlblech, pulverbeschichtet/ Steel plates, powder-coated
Materialstärke/Material Thickness:	0,8 mm
Farbe/Colour:	Blau/Blue
Abmessungen (HxBxD)/Dimensions (HxWxD):	1.010 x 678 x 459 mm
Belastbarkeit pro Schubfach/Max. Capacity per Drawer:	35 kg
Belastbarkeit insgesamt/Max. overall Capacity:	400 kg
Gewicht/Weight:	50 kg
Rollenabmessungen/Roll Dimensions:	Ø 127 x 32 mm

- ▶ *Good stability and torsional stiffness*
- ▶ *6 Drawers (3 x 75 mm, 3 x 154 mm Height)*
- ▶ *Smooth-running ball bearing slides*
- ▶ *Due to Only-One-Drawer (OOD) system – only one drawer at a time may be opened*
- ▶ *Central locking system*
- ▶ *Castors: PVC, 2 x fixed, 2 x dirigible*
- ▶ *Full Break System*
- ▶ *One handhold included*
- ▶ *Customized assembling with up to 3 PROForm inlays*

Weitere Technische Details siehe Seite H 22
More technical data please find on page H 22

Zubehör siehe Seiten H 19 - H 21
Accessories please find on pages H 19 - H 21

PROForm Werkzeugeinlagen ab Seite H 32
PROForm Tool Sets find from page H 32

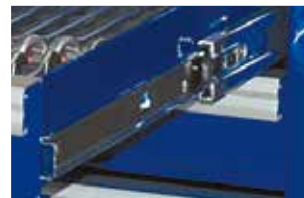

Kugelgelagerte Schubfachauszüge
Ball Bearing Slides



Rollen mit Roll- und Drehbremse
Full Break System

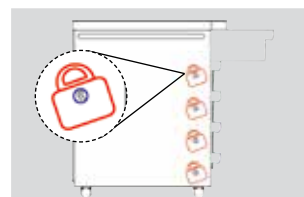

Zentralverriegelung
Central Locking System



Inklusive stabilem Handgriff
Handhold Included

Art.-Nr./Art.-No.	Farbe/Color
4901-50	Blau/Blue

Werkstattwagen Zubehör für »RedLine«, »SuperBlue«, »BlackLine« und »ECOBlue«

Roller Cabinet Accessories for »RedLine«, »SuperBlue«, »BlackLine« and »ECOBlue«

Art.-Gruppe 173
Article Group 173

Ablage-Tisch
Side Table

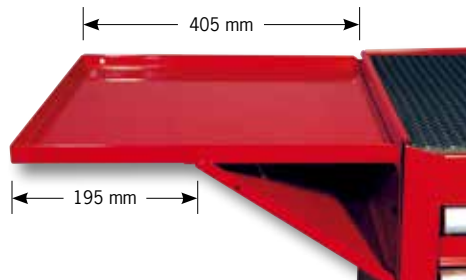

Art.-Nr./Art.-No.	Farbe/Colour
5907	Rot/Red
5907-20	Schwarz/Black
5907-50	Blau/Blue

Arbeitsauflage aus Kunststoff
Top Table



Arbeitsauflageplatte aus Holz, 15 mm stark
Wooden Top Table
15 mm



Kannen-/Dosenhalter
Can Holder

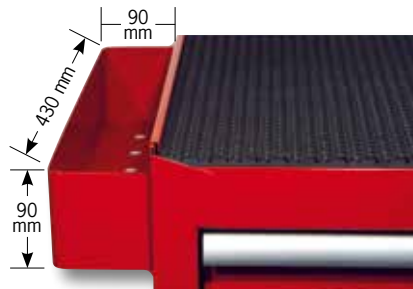

Art.-Nr./Art.-No.	Farbe/Colour
5908*	Rot/Red
5908-20*	Schwarz/Black
5908-50*	Blau/Blue

*nicht passend für »ECOBlue«-Werkstattwagen
*not fitting »ECOBlue« Roller Cabinet

Art.-Nr./Art.-No.	Beschr./Description
5909	Arbeitsauflage Kunststoff/Top Table
5921	Arbeitsauflageplatte Holz/Wooden Top Table
5922	Ersatzauflegematte/Replacement Pad

Magnetische Lochwand inkl. 10 Haken, 450 mm, max. 6 kg

Magnetic Tool Rack with 10 hooks, 450 mm, max. 6 kg



Art.-Nr./Art.-No.	tlg./pcs.
5912	11
5912-10	Einzelhaken 10er Pack/Single Hooks 10 pieces

Magnetische Universalablage
Magnetic Tray

310 x 115 x 31 mm



Art.-Nr./Art.-No.	Belastbarkeit/Loading Capacity
5910	max. 3,5 kg
5911	max. 4,0 kg

Papierkorb zu Werkstattwagen
Plastic Cask



Art.-Nr./Art.-No.	Beschr./Description
5913	Papierkorb/Plastic Cask

Werkstattwagen Zubehör für »RedLine«, »SuperBlue«, »BlackLine« und »ECOBlue«

Roller Cabinet Accessories for »RedLine«, »SuperBlue«, »BlackLine« and »ECOBlue«

Art.-Gruppe 173
Article Group 173

PROFESSIONAL **PLUS** STANDARD

5997-001

Handgriff »RedLine«
Handhold »RedLine«

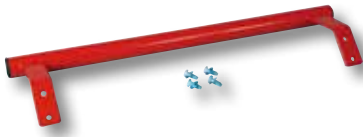

Art.-Nr./Art.-No.	Beschr./Descr.
5997-001	RedLine

PROFESSIONAL **PLUS** STANDARD

5997-002

Handgriff »SuperBlue«/»ECOBlue«
Handhold »SuperBlue«/»ECOBlue«

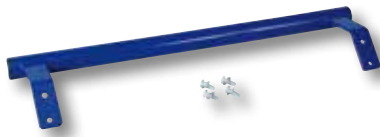

Art.-Nr./Art.-No.	Beschr./Descr.
5997-002	SuperBlue/ECOBlue

PROFESSIONAL **PLUS** STANDARD

5997-013

Handgriff »BlackLine«
Handhold »BlackLine«

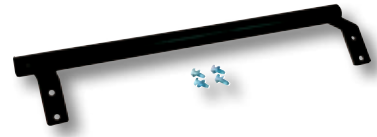

Art.-Nr./Art.-No.	Beschr./Descr.
5997-013	BlackLine

PROFESSIONAL **PLUS** STANDARD

5997-003

Kugelgelagerter Schubfachauszug für »RedLine«, »SuperBlue«, »BlackLine« und »SpaceLine«
Ball Bearing Drawer Pullout for »RedLine«, »SuperBlue«, »BlackLine« and »SpaceLine«



Art.-Nr./Art.-No.	Beschr./Descr.
5997-003	Auszug

PROFESSIONAL **PLUS** STANDARD

5997-014

Kugelgelagerter Schubfachauszug für »ECOBlue«
Ball Bearing Slides for »ECOBlue«



Art.-Nr./Art.-No.	Beschr./Descr.
5997-014	Auszug ECOBlue

PROFESSIONAL **PLUS** STANDARD

5997-011 / 5997-012

Ersatzrollen für »RedLine«, »SuperBlue« und »BlackLine«
Spare Castor for »RedLine«, »SuperBlue« and »BlackLine«



5997-011
Bockrolle starr/
fixed castor

5997-012
Lenkrolle mit
Feststellfunktion/
dirigible castor with stopper

Art.-Nr./Art.-No.	Beschr./Descr.
5997-011	Bockrolle/fixed castor
5997-012	Lenkrolle/dirigible castor

PROFESSIONAL **PLUS** STANDARD

5997-015 / 5997-016

Ersatzrollen für »ECOBlue«
Spare Castor for »ECOBlue«



Art.-Nr./Art.-No.	Beschr./Descr.
5997-015	Bockrolle/fixed castor
5997-016	Lenkrolle/dirigible castor

5998-XXX (Bitte Nr. des Zylinders angeben)

Schließzylinder mit 2 Schlüsseln
Cylinder Lock and 2 Keys



Art.-Nr./Art.-No.	Beschr./Descr.
5998-XXX	Schließzylinder

(Bitte Nr. des Zylinders angeben/Please state the cylinder number)

5996-XXX (Bitte Nr. des Zylinders angeben)

Schlüssel
Key



Art.-Nr./Art.-No.	Beschr./Descr.
5996-XXX	Schlüssel

(Bitte Nr. des Zylinders angeben/Please state the cylinder number)

Werkstattwagen Zubehör für alle PROJAHN Werkstattwagen

Roller Cabinet Accessories for every PROJAHN Roller Cabinet

Art.-Gruppe 173
Article Group 173

5914

Schubfachunterteiler: Basiselement
566 x 65,6 x 1 mm aus Metall
(pro Schublade 2 Stück erforderlich)
Drawer Divider of Front and Back Side
(2 pieces per drawer required)

5915

Schubfachunterteiler: gerade/längs
392 x 60 x 1,4 mm aus Metall
Drawer Divider of Straight

5916

Schubfachunterteiler „XL“
187,9 x 50 x 1,4 mm aus Metall
Drawer Divider „XL“

5917

Schubfachunterteiler „L“
149,9 x 50 x 1,4 mm aus Metall
Drawer Divider „L“

Art.-Nr./Art.-No.	Beschr./Description
5914	Basis
5915	gerade/längs
5916	XL
5917	L
5918	M
5919	S
5920	Set

5918

Schubfachunterteiler „M“
111,9 x 50 x 1,4 mm aus Metall
Drawer Divider „M“

5919

Schubfachunterteiler „S“
79,4 x 50 x 1,4 mm aus Metall
Drawer Divider „S“

5920

Schubfachunterteiler Set
Drawer Divider Set
Inhalt/Contents:
2x Basiselement (5914)
4x Unterteiler „gerade“ (5915)
2x Unterteiler „XL“ (5916)
2x Unterteiler „L“ (5917)
3x Unterteiler „M“ (5918)
4x Unterteiler „S“ (5919)

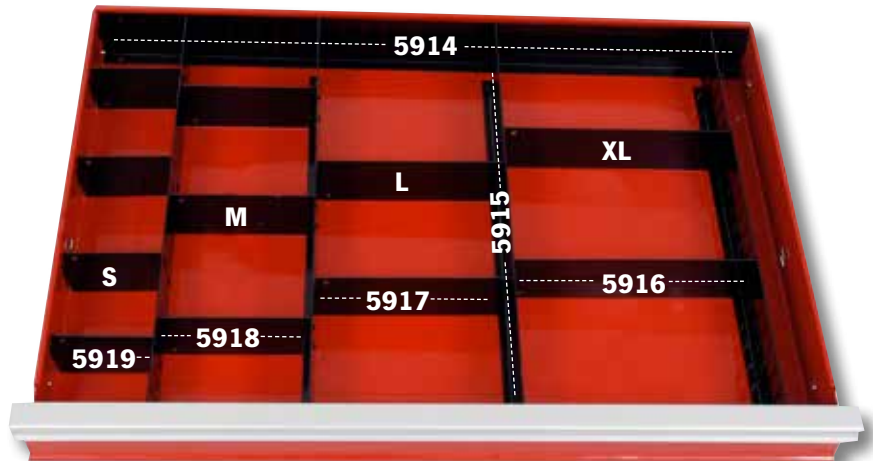

Wie in Artikel 5920 beschrieben/Similar to Art. 5920

Magnetschalen

Magnetic Trays

Mit starkem, gummiüberzogenen Dauermagneten.
Zum Aufbewahren von Kleinwerkzeugen und Kleinteilen
wie Schrauben und Muttern bei Montage und im
Garagengewerbe.
Magnetkraft bis 1200 g.

With strong, rubber protected continous magnets.
Optimal to store small tools and parts, such as screws and
nuts, at instalation jobs and in the automotive field.
Magnetic power up to 1200 g.



Art.-Nr./Art.-No.	Größe/Size
2950	Ø 150 mm rund/round
2951	240 x 140 mm eckig/rectangular

Werkstattwagen – Technische Daten

Roller Cabinets – Technical Data

5901, 5901-50, 5901-20

RedLine 7

SuperBlue

BlackLine

Material: Stahlblech, pulverbeschichtet
 Materialstärke: 0,9 mm
 Konstruktion: Doppelwandkonstruktion
 Farben: Blau, Rot, Schwarz
 Abmessungen (HxBxT): 1.000 x 676 x 459 mm
 Anzahl Schubfächer: 7
 Höhe Schubfächer: 2 x 154 mm, 5 x 75 mm
 Innenabm. Schubf. (BxT): 560 x 395 mm
 Belastbarkeit pro Schubfach: 40 kg
 Belastbarkeit insgesamt: 600 kg
 Gewicht: 63 kg
 Rollenabmessung (ØxB): 127 x 50 mm

Material: Steel plates, powder-coated
 Material thickness: 0,9 mm
 Construction: Double wall construction
 Colours: Blue, Red, Black
 Dimensions (HxWxD): 1.000 x 676 x 459 mm
 Number of drawers: 7
 Height of drawers: 2 x 154 mm, 5 x 75 mm
 Inside dimensions drawers (WxD): 560 x 395 mm
 Max. Capacity per drawer: 40 kg
 Max. overall Capacity: 600 kg
 Weight: 63 kg
 Dimensions rolls (ØxB): 127 x 50 mm

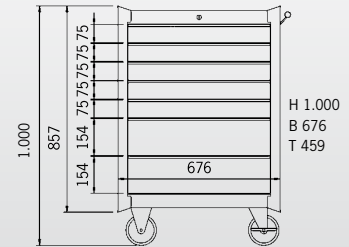

7901-50

SPACE Line

Material: Stahlblech, pulverbeschichtet
 Materialstärke: 0,8 - 0,9 mm
 Konstruktion: Doppelwandkonstruktion
 Farbe: Blau/Anthrazit
 Abmessungen (HxBxT): 990 x 910 (990 inkl. Griff) x 475 mm
 Anzahl Schubfächer: 7
 Höhe Schubfächer: 2 x 154, 5 x 75 mm
 Innenabm. Schubf. (BxT): 560 x 395 mm
 Belastbarkeit pro Schubfach: 40 kg
 Belastbarkeit insgesamt: 500 kg
 Gewicht: 72 kg
 Rollenabmessung (ØxB): 127 x 50 mm

Material: Steel plates, powder-coated
 Material thickness: 0,8 - 0,9 mm
 Construction: Double wall construction
 Colour: Blue/Anthracite
 Dimensions (HxWxD): 990 x 910 (990 incl. Handle) x 475 mm
 Number of drawers: 7
 Height of drawers: 2 x 154 mm, 5 x 75 mm
 Inside dimensions drawers (WxD): 560 x 395 mm
 Max. Capacity per drawer: 40 kg
 Max. overall Capacity: 500 kg
 Weight: 72 kg
 Dimensions rolls (ØxB): 127 x 50 mm

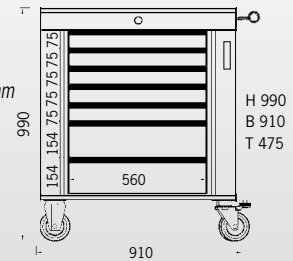

4901-50

ECOBlue

Material: Stahlblech, pulverbeschichtet
 Materialstärke: 0,8 mm
 Farbe: Blau
 Abmessungen (HxBxT): 1.010 x 676 x 459 mm
 Anzahl Schubfächer: 6
 Höhe Schubfächer: 3 x 154, 3 x 75 mm
 Innenabm. Schubf. (BxT): 560 x 395 mm
 Belastbarkeit pro Schubfach: 35 kg
 Belastbarkeit insgesamt: 400 kg
 Gewicht: 50 kg
 Rollenabmessung (ØxB): 127 x 32 mm

Material: Steel plates, powder-coated
 Material thickness: 0,8 mm
 Colour: Blue
 Dimensions (HxWxD): 1.010 x 676 x 459 mm
 Number of drawers: 6
 Height of drawers: 3 x 154 mm, 3 x 75 mm
 Inside dimensions drawers (WxD): 560 x 395 mm
 Max. Capacity per drawer: 30 kg
 Max. overall Capacity: 300 kg
 Weight: 50 kg
 Dimensions rolls (ØxB): 127 x 32 mm

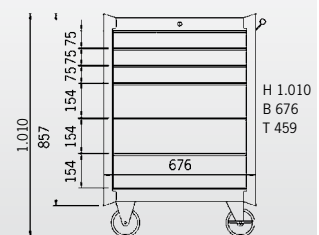

PROForm-Box – Koffersystem für PROForm Werkstattwagen-Einlagen

PROForm-Box – Cases for PROForm Inlays

Art-Gruppe 172/179
Article Group 172/179

5953

PROForm-Box 1: Mobiler Koffer für eine PROForm-Werkzeug-Einlage (395 x 186 mm)

PROForm-Box 1: Mobile Case for one PROForm Tool Inlay (395 x 186 mm)

Stellen Sie sich Ihren eigenen Werkzeugkoffer zusammen oder machen Sie Ihre Werkstattwagen-Werkzeuge noch mobiler!

Customize your own Tool Set or make your Roller Cabinet Tools available!

- ▶ **INDIVIDUELL und BEQUEM:** Konfigurieren Sie Ihren eigenen Werkzeugkoffer oder wählen Sie aus unseren Topseller-Konfigurationen
 - ▶ **KOMPAKT:** Platzsparend und daher ideal für unterwegs
 - ▶ **MOBIL und FLEXIBEL:** Benötigte Werkzeug-Einlage vom Werkstattwagen in die PROForm-Box umpacken und mitnehmen
 - ▶ **STABIL und LANGLEBIG:** Sichere und saubere Werkzeugaufbewahrung
-
- ▶ *INDIVIDUAL and COMFORTABLE:* Customize your own tool set or choose from our top-seller configurations
 - ▶ *COMPACT:* Space saving and therefore ideal for mobile use
 - ▶ *MOBILE and FLEXIBLE:* PROForm-Box is able to fit one PROForm inlay from your roller cabinet which makes your tools mobile
 - ▶ *DURABLE:* Tools are secured to be shock and jolt-proof

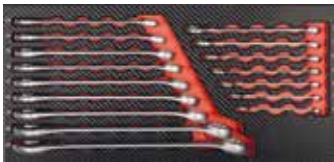

5953-011
PROForm-BOX mit Einlage Ringgabelschlüssel/
PROForm-BOX incl. Combination Wrench Inlay

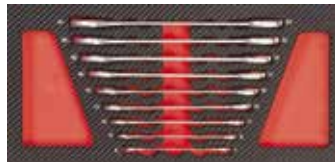

5953-021
PROForm-BOX mit Einlage Doppelgabelschlüssel/
PROForm-BOX incl. Double Open End Wrench Inlay



5953-131
PROForm-BOX mit Einlage 1/2" Steckschlüssel/
PROForm-BOX incl. 1/2" Socket Inlay



5953-065
PROForm-BOX mit Einl. PH-/PZ-/Schlitz-Schraubendr./
PROForm-BOX incl. PH-/PZ-/Slotted Screwdriver Inlay



5953-082
PROForm-BOX mit Einlage Zangen/
PROForm-BOX incl. Pliers Inlay



5953-101
PROForm-BOX mit Einlage Schlagwerkzeuge/
PROForm-BOX incl. Hammer and Punch Inlay

Weitere PROForm-Werkstatteinlagen ab Seite /
More PROForm Inlays for Roller Cabinet from Page **H 32**

Art.-Nr./Art.-No.	Beschreibung/Description	tlg./pcs
5953	PROForm-Box 1 – Leerkoffer/Empty Box	
5953-011	PROForm-Box mit Einlage Ringgabelschlüssel/ <i>incl. Combination Wrench Inlay</i>	16
5953-021	PROForm-Box mit Einlage Doppelgabelschlüssel/ <i>incl. Double Open End Wrench Inlay</i>	8
5953-131	PROForm-Box mit Einlage 1/2" Steckschlüssel/ <i>incl. 1/2" Socket Inlay</i>	24
5953-065	PROForm-Box mit Einlage PH-/PZ-/Schlitz-Schraubendreher/ <i>incl. PH-/PZ-/Slotted Screwdriver Inlay</i>	8
5953-082	PROForm-Box mit Einlage Zangen/ <i>incl. Pliers Inlay</i>	4
5953-101	PROForm-Box mit Einlage Schlagwerkzeuge/ <i>incl. Hammer and Punch Inlay</i>	6

PROForm-Box – Koffersystem für PROForm Werkstattwagen-Einlagen

PROForm-Box – Cases for PROForm Inlays

Art.-Gruppe 172/179
Article Group 172/179

5954

PROForm-Box 3: Mobiler Koffer für eine PROForm-Werkzeug-Einlage (395 x 560 mm) oder drei Werkzeug-Einlagen (395 x 186 mm)

PROForm-Box 3: Mobile Case for one PROForm Tool Inlay (395 x 560 mm) or Three Tool Inlays (395 x 186 mm)

Stellen Sie sich Ihren eigenen Werkzeugkoffer zusammen oder machen Sie Ihre Werkstattwagen-Werkzeuge noch mobiler!

Customize your own Tool Set or make your Roller Cabinet Tools available!

- ▶ **INDIVIDUELL:** Konfigurieren Sie Ihren eigenen Werkzeugkoffer aus bis zu drei PROForm-Einlagen
- ▶ **BEQUEM:** Oder wählen Sie aus unseren Topseller-Konfigurationen
- ▶ **MOBIL und FLEXIBEL:** Benötigte Werkzeug-Einlage vom Werkstattwagen in die PROForm-Box umpacken und mitnehmen
- ▶ **STABIL und LANGLEBIG:** Sichere und saubere Werkzeugaufbewahrung

- ▶ *INDIVIDUAL:* Customize your own tool set from up to three PROForm inlays
- ▶ *COMFORTABLE:* Or choose from our top-seller configurations
- ▶ *MOBILE and FLEXIBLE:* PROForm-Box is able to fit up to three PROForm inlays from your roller cabinet which makes your tools mobile
- ▶ *DURABLE:* Tools are secured to be shock and jolt-proof



5954-001 - Set, 48-tgl./48 pcs.
PROForm-BOX Set bestehend aus/
composed of 5999-011 + 5999-131 + 5999-065

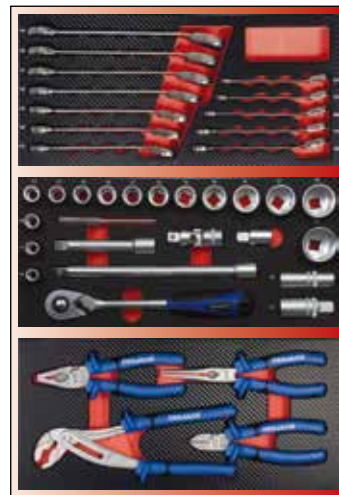

5954-002 - Set, 39-tgl./39 pcs.
PROForm-BOX Set bestehend aus/
composed of 5999-041 + 5999-531 + 5999-082



5954-003 - Set, 18-tgl./18 pcs.
PROForm-BOX Set bestehend aus/
composed of 5999-101 + 5999-065 + 5999-082

Weitere PROForm-Werkstatteinlagen ab Seite /
More PROForm Inlays for Roller Cabinet from Page **H 32**

Art.-Nr./Art.-No.	Beschreibung/Description	tlg./pcs
5954	PROForm-Box 3 – Leerkoffer/Empty Box	
5954-001	PROForm-Box Set 3 bestehend aus/composed of 5999-011 + 5999-131 + 5999-065	48
5954-002	PROForm-Box Set 3 bestehend aus/composed of 5999-041 + 5999-531 + 5999-082	39
5954-003	PROForm-Box Set 3 bestehend aus/composed of 5999-101 + 5999-065 + 5999-082	18

Werkstattwagen-Bestückung für 2 Schubfächer, 67-teilig

Roller Cabinet Sets for 2 Drawers, 67 pieces

67
tlg./pcs.

Art.-Gruppe 171/172
Article Group 171/172

Wählen Sie Ihren Werkstattwagen mit Bestückung oder nur die Bestückung

Choose your Roller Cabinet with Sets
or only the sets



Legende auf Seite H 36

Art.-Nr./Art.-No.	Produkt/Product
5995-001	Bestückung 67-tlg./ Sets with 67 pcs.
7901-501	Werkstattw. »SpaceLine«, 7 Schubf. mit Bestückung/with Sets
5901-101	Werkstattw. »RedLine«, 7 Schubf. mit Bestückung/with Sets
5901-551	Werkstattw. »SuperBlue«, 7 Schubf. mit Bestückung/with Sets
5901-201	Werkstattw. »BlackLine«, 7 Schubf. mit Bestückung/with Sets
4901-501	Werkstattw. »ECOBlue«, 6 Schubf. mit Bestückung/with Sets

7901-501

Werkstattwagen »SpaceLine« mit 7 Schubfächern, bestückt

Roller Cabinet »SpaceLine«,
7 Drawers with Sets

5901-101

Werkstattwagen »RedLine« mit 7 Schubfächern, bestückt

Roller Cabinet »RedLine«, 7 Drawers with Sets

5901-551

Werk. »SuperBlue« mit 7 Schubfächern, bestückt

Roller Cabinet »SuperBlue«, 7 Drawers with Sets

5901-201

Werkstattwagen »BlackLine« mit 7 Schubfächern, bestückt

Roller Cabinet »BlackLine«, 7 Drawers with Sets

4901-501

Werkstattwagen »ECOBlue« mit 6 Schubfächern, bestückt

Roller Cabinet »ECOBlue«, 6 Drawers with Sets



5995-001

Bestehend aus / Composed of

5999-131 + 5999-011 + 5999-021 + 5999-082 + 5999-065 + 5999-101

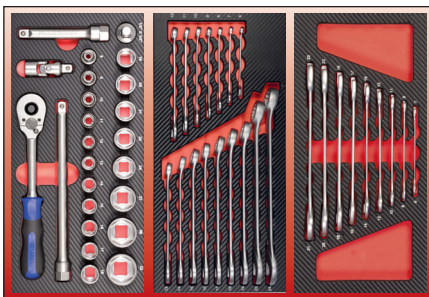

Werkstattwagen-Bestückung für 2 Schubfächer, 148-teilig

Roller Cabinet Sets for 2 Drawers, 148 pieces

148
tlg./pcs.

Art.-Gruppe 171/172
Article Group 171/172

Wählen Sie Ihren Werkstattwagen mit Bestückung oder nur die Bestückung

Choose your Roller Cabinet with Sets or only the sets



Legende auf Seite H 36

Art.-Nr./Art.-No.	Produkt/Product
5995-002	Bestückung 148-tlg./ Sets with 148 pcs.
7901-502	Werkstattw. »SpaceLine«, 7 Schubf. mit Bestückung/with Sets
5901-102	Werkstattw. »RedLine«, 7 Schubf. mit Bestückung/with Sets
5901-552	Werkstattw. »SuperBlue«, 7 Schubf. mit Bestückung/with Sets
5901-202	Werkstattw. »BlackLine«, 7 Schubf. mit Bestückung/with Sets
4901-502	Werkstattw. »ECOBlue«, 6 Schubf. mit Bestückung/with Sets

7901-502

Werkstattwagen »SpaceLine« mit 7 Schubfächern, bestückt

Roller Cabinet »SpaceLine«, 7 Drawers with Sets

5901-102

Werkstattwagen »RedLine« mit 7 Schubfächer, bestückt

Roller Cabinet »RedLine«, 7 Drawers with Sets

5901-552

Werkst. »SuperBlue« mit 7 Schubfächer, bestückt

Roller Cabinet »SuperBlue«, 7 Drawers with Sets

5901-202

Werkstattwagen »BlackLine« mit 7 Schubfächer, bestückt

Roller Cabinet »BlackLine«, 7 Drawers with Sets

4901-502

Werkstattwagen »ECOBlue« mit 6 Schubfächer, bestückt

Roller Cabinet »ECOBlue«, 6 Drawers with Sets



5995-002

Bestehend aus / Composed of

5999-111 + 5999-131 + 5999-191 + 5999-011 + 5999-082 + 5999-065

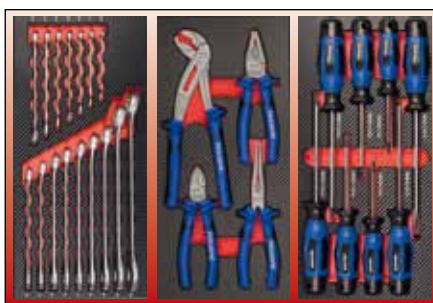

Werkstattwagen-Bestückung für 3 Schubfächer, 171-teilig

Roller Cabinet Sets for 3 Drawers, 171 pieces

171
tlg./pcs.

Art.-Gruppe 171/172
Article Group 171/172

Wählen Sie Ihren Werkstattwagen mit Bestückung oder nur die Bestückung

Choose your Roller Cabinet with Sets or only the sets



Legende auf Seite H 36

Art.-Nr./Art.-No.	Produkt/Product
5995-011	Bestückung 171-tlg./ Sets with 171 pcs.
7901-511	Werkstattw. »SpaceLine«, 7 Schubf. mit Bestückung/with Sets
5901-111	Werkstattw. »RedLine«, 7 Schubf. mit Bestückung/with Sets
5901-511	Werkstattw. »SuperBlue«, 7 Schubf. mit Bestückung/with Sets
5901-211	Werkstattw. »BlackLine«, 7 Schubf. mit Bestückung/with Sets
4901-511	Werkstattw. »ECOBlue«, 6 Schubf. mit Bestückung/with Sets

7901-511

Werkstattwagen »SpaceLine« mit 7 Schubfächern, bestückt

Roller Cabinet »SpaceLine«, 7 Drawers with Sets

5901-111

Werkstattwagen »RedLine« mit 7 Schubfächern, bestückt

Roller Cabinet »RedLine«, 7 Drawers with Sets

5901-511

Werkst. »SuperBlue« mit 7 Schubfächern, bestückt

Roller Cabinet »SuperBlue«, 7 Drawers with Sets

5901-211

Werkstattwagen »BlackLine« mit 7 Schubfächern, bestückt

Roller Cabinet »BlackLine«, 7 Drawers with Sets

4901-511

Werkstattwagen »ECOBlue« mit 6 Schubfächern, bestückt

Roller Cabinet »ECOBlue«, 6 Drawers with Sets



5995-011

Bestehend aus / Composed of

5999-111 + 5999-131 + 5999-191 + 5999-011 + 5999-321 + 5999-021 + 5999-082 + 5999-065 + 5999-101

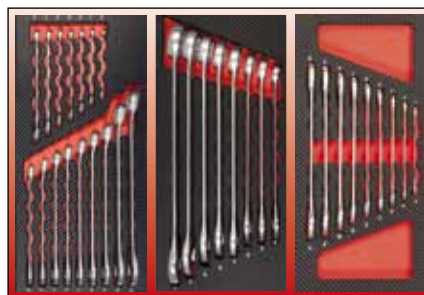

Werkstattwagen-Bestückung für 4 Schubfächern, 179-teilig

Roller Cabinet Sets for 4 Drawers, 179 pieces

179
tlg./pcs.

Art.-Gruppe 171/172
Article Group 171/172

Wählen Sie Ihren Werkstattwagen mit Bestückung oder nur die Bestückung

Choose your Roller Cabinet with Sets or only the sets

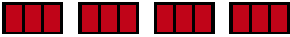

Legende S. H 36

Art.-Nr./Art.-No.	Produkt/Product
5995-023	Bestückung 179-tlg./ Sets with 179 pcs.
7901-523	Werkstattw. »SpaceLine«, 7 Schubf. mit Bestückung/with Sets
5901-123	Werkstattw. »RedLine«, 7 Schubf. mit Bestückung/with Sets
5901-523	Werkstattw. »SuperBlue«, 7 Schubf. mit Bestückung/with Sets
5901-223	Werkstattw. »BlackLine«, 7 Schubf. mit Bestückung/with Sets
4901-523	Werkstattw. »ECOBlue«, 6 Schubf. mit Bestückung/with Sets

7901-523

Werkstattwagen »SpaceLine« mit 7 Schubfächern, bestückt
Roller Cabinet »SpaceLine«, 7 Drawers with Sets

5901-123

Werkstattwagen »RedLine« mit 7 Schubfächern, bestückt
Roller Cabinet »RedLine«, 7 Drawers with Sets

5901-523

Werkst. »SuperBlue« mit 7 Schubfächern, bestückt
Roller Cabinet »SuperBlue«, 7 Drawers with Sets

5901-223

Werkstattwagen »BlackLine« mit 7 Schubfächern, bestückt
Roller Cabinet »BlackLine«, 7 Drawers with Sets

4901-523

Werkstattwagen »ECOBlue« mit 6 Schubfächern, bestückt
Roller Cabinet »ECOBlue«, 6 Drawers with Sets



5995-023

Bestehend aus / Composed of

5999-111 + 5999-131 + 5999-191 + 5999-011 + 5999-321 + 5999-021 + 5999-065 + 5999-062 + 5999-101 + 5999-082 + 5999-171 + 5999-331

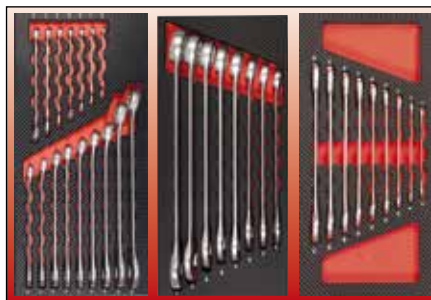

Werkstattwagen-Bestückung für 4 Schubfächern, 198-teilig

Roller Cabinet Sets for 4 Drawers, 198 pieces

198
tlg./pcs.

Art-Gruppe 171/172
Article Group 171/172

Wählen Sie Ihren Werkstattwagen mit Bestückung oder nur die Bestückung

Choose your Roller Cabinet with Sets
or only the sets

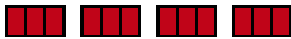

Legende S. H 36

Art.-Nr./Art.-No.	Produkt/Product
5995-022	Bestückung 198-tlg./ Sets with 198 pcs.
7901-522	Werkstattw. »SpaceLine«, 7 Schubf. mit Bestückung/with Sets
5901-122	Werkstattw. »RedLine«, 7 Schubf. mit Bestückung/with Sets
5901-522	Werkstattw. »SuperBlue«, 7 Schubf. mit Bestückung/with Sets
5901-222	Werkstattw. »BlackLine«, 7 Schubf. mit Bestückung/with Sets
4901-522	Werkstattw. »ECOBlue«, 6 Schubf. mit Bestückung/with Sets

7901-522

Werkstattwagen »SpaceLine« mit 7 Schubfächern, bestückt

Roller Cabinet »SpaceLine«,
7 Drawers with Sets

5901-122

Werkstattwagen »RedLine« mit 7 Schubfächern, bestückt

Roller Cabinet »RedLine«, 7 Drawers with Sets

5901-522

Werkst. »SuperBlue« mit 7 Schubfächern, bestückt

Roller Cabinet »SuperBlue«, 7 Drawers with Sets

5901-222

Werkstattwagen »BlackLine« mit 7 Schubfächern, bestückt

Roller Cabinet »BlackLine«, 7 Drawers with Sets

4901-522

Werkstattwagen »ECOBlue« mit 6 Schubfächern, bestückt

Roller Cabinet »ECOBlue«, 6 Drawers with Sets



5995-022

Bestehend aus / Composed of

5999-111 + 5999-131 + 5999-191 + 5999-011 + 5999-321 + 5999-021 +
5999-065 + 5999-082 + 5999-101 + 5999-181 (Dreifacheinlage/Triple Set)

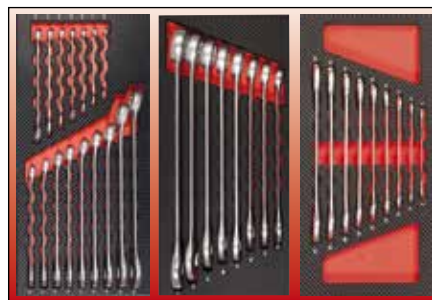
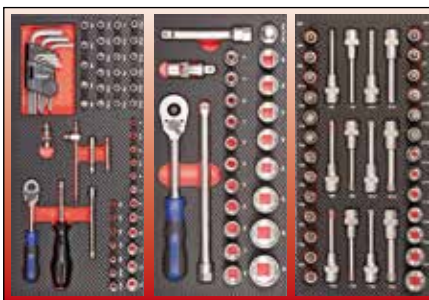

Werkstattwagen-Bestückung für 4 Schubfächern, 210-teilig

Roller Cabinet Sets for 4 Drawers, 210 pieces

210
tlg./pcs.

Art.-Gruppe 171/172
Article Group 171/172

Wählen Sie Ihren Werkstattwagen mit Bestückung oder nur die Bestückung

Choose your Roller Cabinet with Sets or only the sets



Legende S. H 36

Art.-Nr./Art.-No.	Produkt/Product
5995-021	Bestückung 210-tlg./ Sets with 210 pcs.
7901-521	Werkstattw. »SpaceLine«, 7 Schubf. mit Bestückung/with Sets
5901-121	Werkstattw. »RedLine«, 7 Schubf. mit Bestückung/with Sets
5901-521	Werkstattw. »SuperBlue«, 7 Schubf. mit Bestückung/with Sets
5901-221	Werkstattw. »BlackLine«, 7 Schubf. mit Bestückung/with Sets
4901-521	Werkstattw. »ECOBlue«, 6 Schubf. mit Bestückung/with Sets

7901-521

Werkstattwagen »SpaceLine« mit 7 Schubfächern, bestückt
Roller Cabinet »SpaceLine«, 7 Drawers with Sets

5901-121

Werkstattwagen »RedLine« mit 7 Schubfächern, bestückt
Roller Cabinet »RedLine«, 7 Drawers with Sets

5901-521

Werkst. »SuperBlue« mit 7 Schubfächern, bestückt
Roller Cabinet »SuperBlue«, 7 Drawers with Sets

5901-221

Werkstattwagen »BlackLine« mit 7 Schubfächern, bestückt
Roller Cabinet »BlackLine«, 7 Drawers with Sets

4901-521

Werkstattwagen »ECOBlue« mit 6 Schubfächern, bestückt
Roller Cabinet »ECOBlue«, 6 Drawers with Sets



5995-021

Bestehend aus / Composed of

5999-111 + 5999-131 + 5999-101 + 5999-011 + 5999-321 + 5999-021 + 5999-065 + 5999-062 + 5999-082 + 5999-331 + 5999-361 (Doppeleinlage/Double Set)

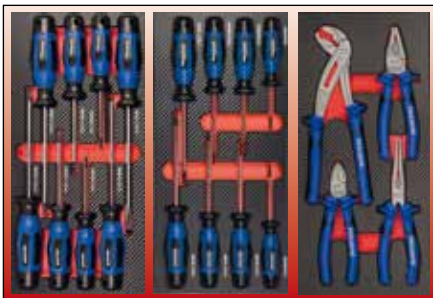
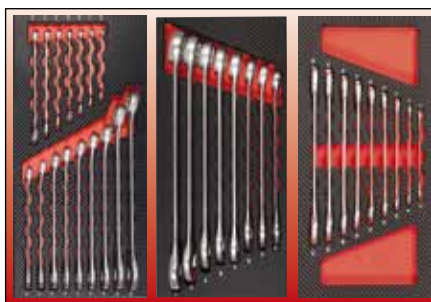

Werkstattwagen-Bestückung für 5 Schubfächer, 320-teilig

Roller Cabinet Sets for 5 Drawers, 320 pieces

320
tlg./pcs.

Art.-Gruppe 171/172
Article Group 171/172

Wählen Sie Ihren Werkstattwagen mit Bestückung oder nur die Bestückung

Choose your Roller Cabinet with Sets
or only the sets



Art.-Nr./Art.-No.	Produkt/Product
5995-141	Bestückung 320-tlg./ Sets with 320 pcs.
7901-541	Werkstattw. »SpaceLine«, 7 Schubf. mit Bestückung/with Sets
5901-141	Werkstattw. »RedLine«, 7 Schubf. mit Bestückung/with Sets
5901-541	Werkstattw. »SuperBlue«, 7 Schubf. mit Bestückung/with Sets
5901-241	Werkstattw. »BlackLine«, 7 Schubf. mit Bestückung/with Sets
4901-541	Werkstattw. »ECOBlue«, 6 Schubf. mit Bestückung/with Sets

7901-541

Werkstattwagen »SpaceLine« mit 7 Schubfächern, bestückt

Roller Cabinet »SpaceLine«,
7 Drawers with Sets

5901-141

Werkstattwagen »RedLine« mit 7 Schubfächern, bestückt

Roller Cabinet »RedLine«, 7 Drawers with Sets

5901-541

Werkst. »SuperBlue« mit 7 Schubfächern, bestückt

Roller Cabinet »SuperBlue«, 7 Drawers with Sets

5901-241

Werkstattwagen »BlackLine« mit 7 Schubfächern, bestückt

Roller Cabinet »BlackLine«, 7 Drawers with Sets

4901-541

Werkstattwagen »ECOBlue« mit 6 Schubfächern, bestückt

Roller Cabinet »ECOBlue«, 6 Drawers with Sets



5995-141

Bestehend aus / Composed of

5999-111 + 5999-131 + 5999-191 + 5999-321 + 5999-011 + 5999-021 + 5999-065 + 5999-062 + 5999-341 + 5999-171 + 5999-082 + 5999-101 + 5999-331 + 5999-393 + 3789

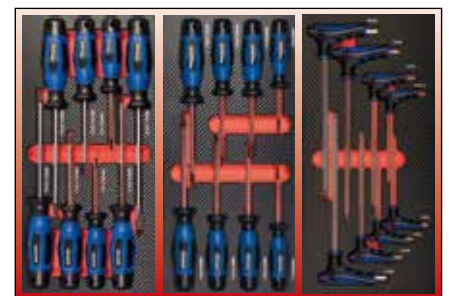
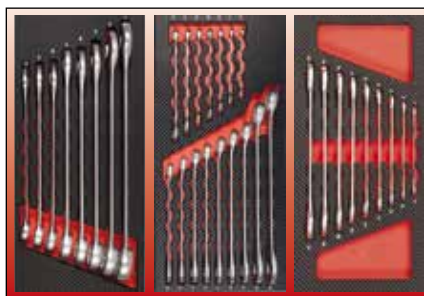

Bit-Box
mit allen
gängigen Bits

PROForm Werkstattwagen Einlagen

PROForm Inlays for Roller Cabinets

Art.-Gruppe 171
Article Group 171

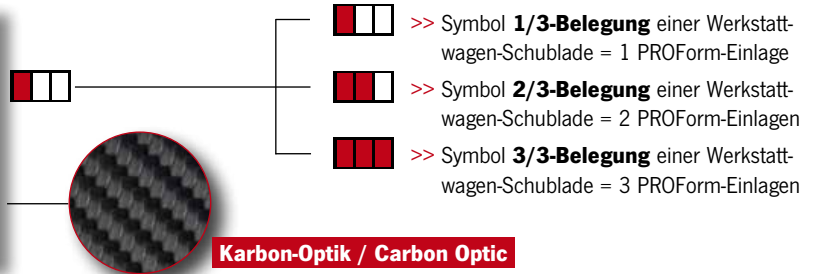
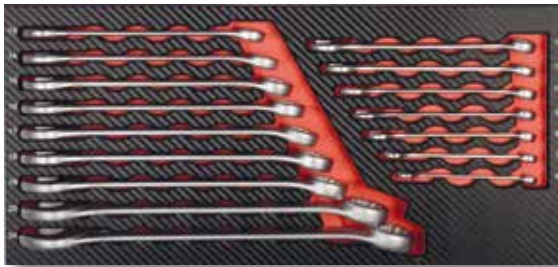

Die PROJAHN PROForm-Einlagen (2-Farben-Kontrast-System) sind passgenau auf alle PROJAHN Werkstattwagen und das PROForm-Box-Koffersystem abgestimmt. Diese PROForm-Einlagen gibt es als Einfach-Einlage (395 x 186 x 35mm), als Doppel-Einlage (395 x 378 x 35mm) oder als Dreifach-Einlage (395 x 568 x 35mm), wobei die Dreifach-Einlage einer kompletten Schublade entspricht. Die PROForm-Einlagen sind aus hochwertigem, bruch- und formstabilem Polymer-Kunststoff gefertigt und bieten Ihren Werkzeugen optimalen Halt und Schutz.

PROJAHN PROForm-Inlays (2-colour-system) are accurate'n produced for all PROJAHN Roller Cabinets and PROForm-Box Cases. These PROForm-Inlays are available as 1/3-inlay (395 x 186 x 35mm), as 2/3-inlay (395 x 378 x 35mm) or as 3/3-inlay (395 x 568 x 35mm). The 3/3-inlay fills a complete drawer. The PROForm-Inlays are produced by special, hard-to-brake, rubber foam and secure your tools.

5999-011 **PROFESSIONAL** PLUS STANDARD

PROForm Einlagesystem Ringgabelschlüssel, 16-teilig

PROForm Combination Wrench Inlay, 16 pieces

Inhalt/Contents:

6 - 7 - 8 - 9 - 10 - 11 - 12 - 13 - 14 - 15 - 16 - 17 - 18 - 19 - 22 - 24 mm



16
tlg./pcs.

395 x 186 x 35 mm

Art.-Nr./Art.-No.	tlg./pcs.	L./L.	B./W.	H./H.	
5999-011	16				
5999-01E		395	186	35	Einlage leer/empty inlay

5999-321 **PROFESSIONAL** PLUS STANDARD

PROForm Einlagesystem Ringgabelschlüssel, 8-teilig

PROForm Combination Wrench Inlay, 8 pieces

Inhalt/Contents:

20 - 21 - 23 - 25 - 26 - 27 - 30 - 32 mm



8
tlg./pcs.

395 x 186 x 35 mm

Art.-Nr./Art.-No.	tlg./pcs.	L./L.	B./W.	H./H.	
5999-321	8				
5999-32E		395	186	35	Einlage leer/empty inlay

PROForm Werkstattwagen Einlagen

PROForm Inlays for Roller Cabinets

Art.-Gruppe 171
Article Group 171

5999-411 **PROFESSIONAL** PLUS STANDARD

PROForm Einlegesystem Ringgabelschlüssel Zoll, 12-teilig

PROForm Combination Wrench Inlay Inch, 12 pieces

Inhalt/Contents:

1/4" - 5/16" - 3/8" - 7/16" - 1/2" - 9/16" - 5/8" -
11/16" - 3/4" - 7/8" - 15/16" - 1"



12
tlg./pcs.



395 x 186 x 35 mm

Art.-Nr./Art.-No.	tlg./pcs.	L./L.	B./W.	H./H.	
5999-411	12				
5999-41E		395	186	35	Einlage leer/empty inlay

5999-021 **PROFESSIONAL** PLUS STANDARD

PROForm Einlegesystem Doppelgabelschlüssel, 9-teilig

PROForm Double Open End Wrench Inlay, 9 pieces

Inhalt/Contents:

6 x 7 - 8 x 9 - 10 x 11 - 12 x 13 - 14 x 15 - 16 x 17 - 18 x 19 - 20 x 22
- 21 x 23 mm



9
tlg./pcs.



395 x 186 x 35 mm

Art.-Nr./Art.-No.	tlg./pcs.	L./L.	B./W.	H./H.	
5999-021	9				
5999-02E		395	186	35	Einlage leer/empty inlay

5999-031 **PROFESSIONAL** PLUS STANDARD

PROForm Einlegesystem Doppelringschlüssel, 8-teilig

PROForm Double Ring Wrench Inlay, 8 pieces

Inhalt/Contents:

6 x 7 - 8 x 9 - 10 x 11 - 12 x 13 - 14 x 15 - 16 x 17 - 18 x 19 - 20 x 22 mm



8
tlg./pcs.



395 x 186 x 35 mm

Art.-Nr./Art.-No.	tlg./pcs.	L./L.	B./W.	H./H.	
5999-031	8				
5999-03E		395	186	35	Einlage leer/empty inlay

PROForm Werkstattwagen Einlagen

PROForm Inlays for Roller Cabinets

Art.-Gruppe 171
Article Group 171

5999-041

PROFESSIONAL PLUS STANDARD

PROForm Einlegesystem GearTech Ratschenschlüssel „umschaltbar“, 12-teilig

PROForm Reversible GearTech Ratcheting Wrench Inlay, 12 pieces

Inhalt/Contents:

8 - 9 - 10 - 11 - 12 - 13 - 14 - 15 - 16 - 17 - 18 - 19 mm



12
tlg./pcs.



395 x 186 x 35 mm

Art.-Nr./Art.-No.	tlg./pcs.	L./L.	B./W.	H./H.	
5999-041	12				
5999-04E		395	186	35	Einlage leer/empty inlay

5999-051

PROFESSIONAL PLUS STANDARD

PROForm Einlegesystem GearTech Ratschenschlüssel „klassik“ ohne Umschaltknopf, 12-teilig

PROForm GearTech „classic“ Inlay, 12 pieces

Inhalt/Contents:

8 - 9 - 10 - 11 - 12 - 13 - 14 - 15 - 16 - 17 - 18 - 19 mm



12
tlg./pcs.



395 x 186 x 35 mm

Art.-Nr./Art.-No.	tlg./pcs.	L./L.	B./W.	H./H.	
5999-051	12				
5999-05E		395	186	35	Einlage leer/empty inlay

5999-052

PROFESSIONAL PLUS STANDARD

PROForm Einlegesystem GearTech Ratschenschlüssel „flexibel“ ohne Umschaltknopf, 12-teilig

PROForm GearTech „flexible“ Inlay, 12 pieces

Inhalt/Contents:

8 - 9 - 10 - 11 - 12 - 13 - 14 - 15 - 16 - 17 - 18 - 19 mm

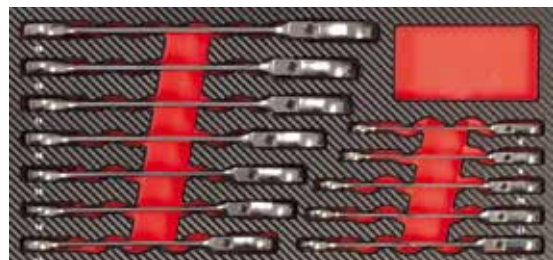

12
tlg./pcs.



395 x 186 x 35 mm

Art.-Nr./Art.-No.	tlg./pcs.	L./L.	B./W.	H./H.	
5999-052	12				
5999-05E		395	186	35	Einlage leer/empty inlay

PROForm Werkstattwagen Einlagen

PROForm Inlays for Roller Cabinets

Art.-Gruppe 171
Article Group 171

5999-111 **PROFESSIONAL** PLUS STANDARD

PROForm Einlegesystem

1/4" Steckschlüssel Satz, 58-teilig

PROForm 1/4" Socket Inlay, 58 pieces

Inhalt/Contents:

Knarre, Steckgriff, Gleitgriff, Inbusschlüssel-Satz 9-teilig, Verlängerungen 50 + 100 mm, Stecknuss Bit Adapter 50 mm, Kardangeln, Innen TX Nüsse E4 - 5 - 6 - 7 - 8 - 10 - 11, 6-kant Nüsse 4 - 4,5 - 5 - 5,5 - 6 - 7 - 8 - 9 - 10 - 11 - 12 - 13 mm,

Bit Nüsse: PH1 - 2 - 3, PZ1 - 2 - 3, Schlitz 4 - 5,5 - 6,5 mm, TX8 - 9 - 10 - 15 - 20 - 25 - 27 - 30 - 40, Inbus 3 - 4 - 5 - 6 - 8 mm

Ratchet, Spinner Handle, Sliding T-Handle, Hex Key Set 9 pieces, Extension Bars 50 + 100 mm, Socket Adapter 50 mm, Universal Joint, TX Sockets E4 - 5 - 6 - 7 - 8 - 10 - 11, Sockets 4 - 4,5 - 5 - 5,5 - 6 - 7 - 8 - 9 - 10 - 11 - 12 - 13 mm,

Bit Sockets: PH1 - 2 - 3, PZ1 - 2 - 3, Slotted 4 - 5,5 - 6,5 mm, TX8 - 9 - 10 - 15 - 20 - 25 - 27 - 30 - 40, Hex 3 - 4 - 5 - 6 - 8 mm

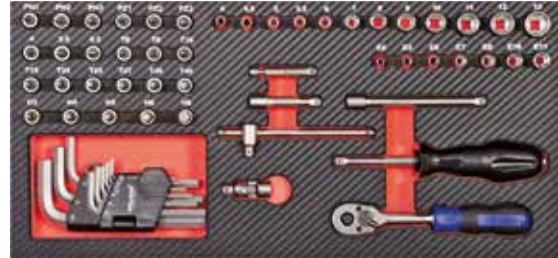

395 x 186 x 35 mm

58
tlg./pcs.

1/4"



Art.-Nr./Art.-No.	tlg./pcs.	L./L.	B./W.	H./H.	
5999-111	58				
5999-11E		395	186	35	Einlage leer/empty inlay

5999-121 **PROFESSIONAL** PLUS STANDARD

PROForm Einlegesystem 3/8" Steckschlüssel Satz, 23-teilig

PROForm 3/8" Socket Inlay, 23 pieces

Inhalt/Contents:

Knarre, T-Gleitadapter, Verlängerungen 75 + 250 mm, Kardangeln, 6-kant Nüsse 6 - 7 - 8 - 9 - 10 - 11 - 12 - 13 - 14 - 15 - 16 - 17 - 18 - 19 - 22 - 24 mm,

Adapter von 3/8" (Knarre) auf 1/4" (Nuss),

Adapter von 3/8" (Knarre) auf 1/2" (Nuss), Adapter von 1/2" (Knarre) auf 3/8" (Nuss)

Ratchet, T-Adapter, Extension Bars 75 + 250 mm, Universal Joint, Sockets 6 - 7 - 8 - 9 - 10 - 11 - 12 - 13 - 14 - 15 - 16 - 17 - 18 - 19 - 22 - 24 mm, Adapter 3/8" (Ratchet) x 1/4" (Socket), Adapter 3/8" (Ratchet) x 1/2" (Socket), Adapter 1/2" (Ratchet) x 3/8" (Socket)



395 x 186 x 35 mm

23
tlg./pcs.

3/8"



Art.-Nr./Art.-No.	tlg./pcs.	L./L.	B./W.	H./H.	
5999-121	23				
5999-12E		395	186	35	Einlage leer/empty inlay

5999-131 **PROFESSIONAL** PLUS STANDARD

PROForm Einlegesystem 1/2" Steckschlüssel Satz, 24-teilig

PROForm 1/2" Socket Inlay, 24 pieces

Inhalt/Contents:

Knarre, T-Gleitadapter, Verlängerungen 125 + 250 mm, Kardangeln, 6-kant Nüsse 8 - 9 - 10 - 11 - 12 - 13 - 14 - 15 - 16 - 17 - 18 - 19 - 20 - 21 - 22 - 24 - 27 - 30 - 32 mm

Ratchet, T-Adapter, Extension Bars 125 + 250 mm, Universal Joint,

Sockets 8 - 9 - 10 - 11 - 12 - 13 - 14 - 15 - 16 - 17 - 18 - 19 - 20 - 21 - 22 - 24 - 27 - 30 - 32 mm

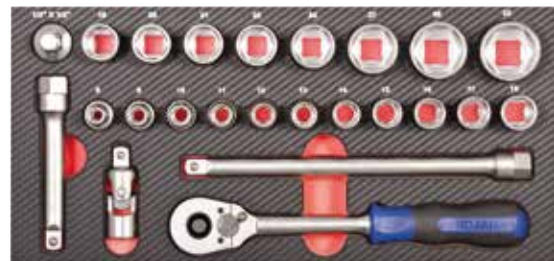

395 x 186 x 35 mm

24
tlg./pcs.

1/2"



Art.-Nr./Art.-No.	tlg./pcs.	L./L.	B./W.	H./H.	
5999-131	24				
5999-13E		395	186	35	Einlage leer/empty inlay

PROForm Werkstattwagen Einlagen

PROForm Inlays for Roller Cabinets

MULTISTECKNUSS
Xi-on

Art.-Gruppe 171
Article Group 171

5999-511 **Xi-on**

PROFESSIONAL PLUS STANDARD

PROForm Einlagesystem 1/4" Xi-on Steckschl. Satz, 18-teilig

PROForm 1/4" Xi-on Socket Inlay, 18 pieces

Inhalt/Contents:

Knarre, 72-Zahn, Steckgriff, Gleitgriff, Verlängerung 50 mm, Kardangeln, Austreiber, Xi-on Stecknüsse 4 - 4,5 - 5 - 5,5 - 6 - 7 - 8 - 9 - 10 - 11 - 12 - 13 mm

Ratchet, 72-Teeth, Spinner Handle, Extension Bars 125 + 250 mm,

Universal Joint, Extractor, Xi-on Sockets 4 - 4,5 - 5 - 5,5 - 6 - 7 - 8 - 9 - 10 - 11 - 12 - 13 mm



395 x 186 x 35 mm

18
tlg./pcs.

1/4"



Art.-Nr./Art.-No.	tlg./pcs.	L./L.	B./W.	H./H.	
5999-511	18				
5999-51E		395	186	35	Einlage leer/empty inlay

5999-521 **Xi-on**

PROFESSIONAL PLUS STANDARD

PROForm Einlagesystem 3/8" Xi-on Steckschl. Satz, 17-teilig

PROForm 3/8" Xi-on Socket Inlay, 17 pieces

Inhalt/Contents:

Knarre, 72-Zahn, Gleitgriff, Verlängerungen 75 + 150 mm, Kardangeln, Austreiber, Xi-on Stecknüsse 8 - 10 - 11 - 12 - 13 - 14 - 15 - 16 - 17 - 18 - 19 mm

Ratchet, 72-Teeth, Sliding T-Handle, Extension Bars 75 + 150mm,

Universal Joint, Extractor, Xi-on Sockets

8 - 10 - 11 - 12 - 13 - 14 - 15 - 16 - 17 - 18 - 19 mm

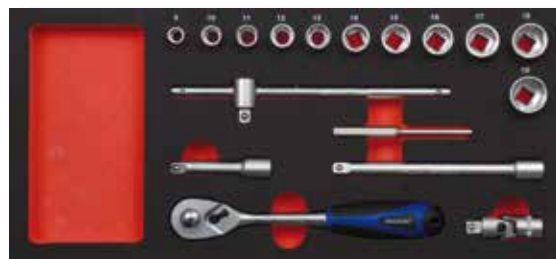

395 x 186 x 35 mm

17
tlg./pcs.

3/8"



Art.-Nr./Art.-No.	tlg./pcs.	L./L.	B./W.	H./H.	
5999-521	17				
5999-52E		395	186	35	Einlage leer/empty inlay

5999-531 **Xi-on**

PROFESSIONAL PLUS STANDARD

PROForm Einlagesystem

1/2" Xi-on Steckschl. Satz, 23-teilig

PROForm 1/2" Xi-on Socket Inlay, 23 pieces

Inhalt/Contents:

Knarre, 60-Zahn, Gleitgriffadapter, Verlängerungen 125 - 250 mm, Kardangeln, Austreiber, Xi-on Stecknüsse 10 - 11 - 12 - 13 - 14 - 15 - 16 - 17 - 18 - 19 - 22 - 24 - 27 - 30 - 32 mm, Zündkerzen-Stecknüsse 16 + 21 mm

Ratchet, 60-Teeth, Sliding T-Handle Adapter, Extension Bars 125 + 250 mm,

Universal Joint, Extractor, Xi-on Sockets 10 - 11 - 12 - 13 - 14 - 15 - 16 -

17 - 18 - 19 - 22 - 24 - 27 - 30 - 32 mm, Spark Plug Sockets 16 + 21 mm



395 x 186 x 35 mm

23
tlg./pcs.

1/2"



Art.-Nr./Art.-No.	tlg./pcs.	L./L.	B./W.	H./H.	
5999-531	23				
5999-53E		395	186	35	Einlage leer/empty inlay

PROForm Werkstattwagen Einlagen

PROForm Inlays for Roller Cabinets

Art.-Gruppe 171
Article Group 171

5999-551

PROFESSIONAL PLUS STANDARD

PROForm Einlegesystem GearTech Durchschraubknarre, 17-teilig

PROForm Go-Through-Socket Inlay, 17 pieces

Inhalt/Contents:

Durchgangsnüsse 10 - 11 - 12 - 13 - 14 - 15 - 16 - 17 - 18 - 19 - 21 - 22 - 24 mm, Verlängerung 80 mm, 1/4" Adapter, 3/8" Adapter, 3D-GearTech-FLEX-Durchschraub-Knarre

Go-Through-Sockets 10 - 11 - 12 - 13 - 14 - 16 - 17 - 18 - 19 - 21 - 22 - 24 mm, Extension 80 mm, 1/4" Adapter, 3/8" Adapter, 3D-GearTech-FLEX-Ratchet



17
tlg./pcs.



395 x 186 x 35 mm

Art.-Nr./Art.-No.	tlg./pcs.	L./L.	B./W.	H./H.	
5999-551	17				
5999-55E		395	186	35	Einlage leer/empty inlay

5999-421

PROFESSIONAL PLUS STANDARD

PROForm Einlegesystem Stecknuss, Zoll, 51-teilig (Doppelinlage)

PROForm Socket Inlay, Inch, 51 pieces (2/3 Inlay)

Inhalt/Contents:

1/4" + 1/2" Knarre, Stecknüsse 3/16" - 1 1/4", Tiefe Stecknüsse 3/16" - 15/16", Gleitgriff-Adapter, Zündkerzen-Stecknüsse 5/16" + 13/16", Kardangeln, Verlängerungen 2" - 3" - 5" - 10", Steckgriff

1/4" + 1/2" Ratchet, Sockets 3/16" - 1 1/4", Deep Sockets 3/16" - 15/16", Sliding T-Adapter, Spark Plug Sockets 5/16" + 13/16", Universal Joint, Extension Bars 2" - 3" - 5" - 10", Spinner Handle



51
tlg./pcs.



395 x 375 x 35 mm

Art.-Nr./Art.-No.	tlg./pcs.	L./L.	B./W.	H./H.	
5999-421	51				
5999-42E		395	375	35	Einlage leer/empty inlay

5999-441

PROFESSIONAL PLUS STANDARD

PROForm Einlegesystem Werkzeugsatz 3/4", 21-teilig (Dreifacheinlage, Höhe 90 mm)

PROForm Socket Inlay 3/4", 21 pieces (3/3 Inlay, High 90 mm)

Inhalt/Contents:

Knarre Verlängerungen 100 - 200 - 400 mm, Gleitgriff, Stecknüsse 19 - 21 - 22 - 23 - 24 - 26 - 27 - 29 - 30 - 32 - 35 - 36 - 38 - 41 - 46 - 50 mm

Ratchet Handle, Extension Bars 100 - 200 - 400 mm, Sliding T-Bar, Sockets 19 - 21 - 22 - 23 - 24 - 26 - 27 - 29 - 30 - 32 - 35 - 36 - 38 - 41 - 46 - 50 mm



21
tlg./pcs.

3/4"



395 x 560 x 35 mm

Art.-Nr./Art.-No.	tlg./pcs.	L./L.	B./W.	H./H.	
5999-441	21				
5999-44E		395	560	35	Einlage leer/empty inlay

PROForm Werkstattwagen Einlagen

PROForm Inlays for Roller Cabinets

Art.-Gruppe 171
Article Group 171

5999-431 **PROFESSIONAL** PLUS STANDARD

PROForm Einlegesystem 1/2" lange Stecknuss, 12-teilig

PROForm 1/2" Deep Impact Socket Inlay, 12 pieces

Inhalt/Contents:

10 - 11 - 12 - 13 - 14 - 15 - 16 - 17 - 18 - 19 - 21 - 22 mm

16 + 21 mm = Zündkerzenstecknüsse / Spark Plug Sockets

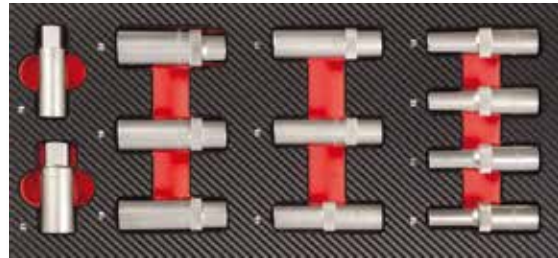

12
tlg./pcs.

1/2"



395 x 186 x 35 mm

Art.-Nr./Art.-No.	tlg./pcs.	L./L.	B./W.	H./H.	
5999-431	12				
5999-43E		395	186	35	Einlage leer/empty inlay

5999-191 **PROFESSIONAL** PLUS STANDARD

PROForm Einlegesystem 1/2" KFZ Spezial-Einlage, 38-teilig

PROForm 1/2" Special Car Repairing Inlay, 38 pieces

Inhalt/Contents:

Inbus-Bit-Nuss 60 mm lang 5 - 6 - 7 - 8 - 10 - 12 mm,

Inbus-Bit-Nuss 100 mm lang 6 - 8 - 10 - 12 mm,

TX-Bit-Nuss 60 mm lang,

TX20 - 25 - 27 - 30 - 40 - 45 - 50 - 55 - 60,

TX-Bit-Nuss 100 mm lang TX30 - 40 - 50 - 60, Vielzahn-Bit-Nuss 60 mm lang M5 - 6 - 8 - 10,

Vielzahn-Bit-Nuss 100 mm lang M6 - 8 - 10 - 12, Innen-TX-Nuss E12 - 14 - 16 - 18 - 20 - 22 - 24

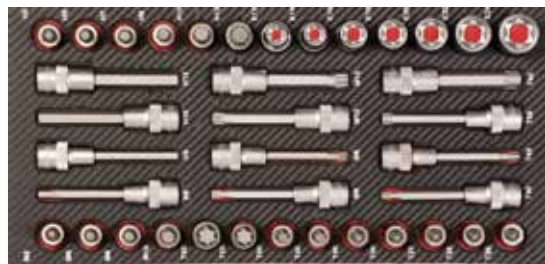

38
tlg./pcs.

1/2"



395 x 186 x 35 mm

Hex Bit Sockets (60 mm) 5 - 6 - 7 - 8 - 10 - 12 mm, Hex Bit Sockets (100 mm) 6 - 8 - 10 - 12mm,

TX Bit Sockets (60 mm) T20 - 25 - 27 - 30 - 40 - 45 - 50 - 55 - 60, TX Bit Sockets (100 mm) T30 - 40 - 50 - 60,

Spline Bit Sockets (60 mm) M5 - 6 - 8 - 10, Spline Bit Sockets (100 mm) M6 - 8 - 10 - 12, TX Sockets E12 - 14 - 16 - 18 - 20 - 22 - 24

Art.-Nr./Art.-No.	tlg./pcs.	L./L.	B./W.	H./H.	
5999-191	38				
5999-19E		395	186	35	Einlage leer/empty inlay

PROForm Werkstattwagen Einlagen

PROForm Inlays for Roller Cabinets

Art.-Gruppe 171
Article Group 171

5999-151

PROFESSIONAL PLUS STANDARD

PROForm Einlagesystem 1/2" Schlagnuss, 30-teilig

PROForm 1/2" Impact Socket Inlay, 30 pieces

Inhalt/Contents:

Nuss 8 - 9 - 10 - 11 - 12 - 13 - 14 - 15 - 16 - 17 - 18 - 19 - 21 - 22 - 24 mm, tiefe Nuss 17 - 19 - 21 - 22 - 24 mm, tiefe Nuss für Alufelgen 17 - 19 - 21 mm, Kardangelenk, Verlängerung 125 mm, Adapter 3/4" (Maschine) auf 1/2" (Nuss), 2x Sicherungsring, 2x Sicherungsstift



395 x 186 x 35 mm

30
tlg./pcs.

1/2"



Sockets 8 - 9 - 10 - 11 - 12 - 13 - 14 - 15 - 16 - 17 - 18 - 19 - 21 - 22 - 24 mm, Deep Sockets 17 - 19 - 21 - 22 - 24 mm, Deep Thin Wall Sockets 17 - 19 - 21 mm, Universal Joint, Extension Bar 125 mm, Adapter 3/4" (Machine) x 1/2" (Socket), 2 pieces Ring for Impact Sockets, 2 pieces Pin for Impact Sockets

Art.-Nr./Art.-No.	tlg./pcs.	L./L.	B./W.	H./H.	
5999-151	30				
5999-15E		395	186	35	Einlage leer/empty inlay

5999-371

PROFESSIONAL PLUS STANDARD

PROForm Einlagesystem 1/2" Schlagnuss, 28-teilig

PROForm 1/2" Impact Socket Inlay, 28 pieces

Inhalt/Contents:

TX-Nuss TX20 - 25 - 27 - 30 - 40 - 45 - 50 - 55 - 60 - 70, Inbus-Nuss 4 - 5 - 6 - 8 - 10 - 12 - 14 - 17 - 19 mm, Innen-TX-Nuss E10 - 11 - 12 - 14 - 16 - 18 - 20 - 22 - 24



395 x 186 x 35 mm

28
tlg./pcs.

1/2"



TX-Sockets TX20 - 25 - 27 - 30 - 40 - 45 - 50 - 55 - 60 - 70, Hex-Sockets 4 - 5 - 6 - 8 - 10 - 12 - 14 - 17 - 19 mm, TX-Sockets E10 - 11 - 12 - 14 - 16 - 18 - 20 - 22 - 24

Art.-Nr./Art.-No.	tlg./pcs.	L./L.	B./W.	H./H.	
5999-371	28				
5999-37E		395	186	35	Einlage leer/empty inlay

5999-141*

PROFESSIONAL PLUS STANDARD

PROForm Einlagesystem Pfeifenkopfschlüssel mit Bohrung, 12-teilig

PROForm Through-Hole Open-Socket Wrench Inlay, 12 pieces

Inhalt/Contents:

8 - 9 - 10 - 11 - 12 - 13 - 14 - 15 - 16 - 17 - 18 - 19 mm



395 x 186 x 35 mm

12
tlg./pcs.



Art.-Nr./Art.-No.	tlg./pcs.	L./L.	B./W.	H./H.	
5999-141*	12				
5999-14E*		395	186	35	Einlage leer/empty inlay

*Lieferung nur solange der Vorrat reicht / Delivery while stocks last

PROForm Werkstattwagen Einlagen

PROForm Inlays for Roller Cabinets

Art.-Gruppe 171
Article Group 171

5999-065 PROFESSIONAL PLUS STANDARD

PROForm Einlagesystem

Phillips-, Pozidriv- und Schlitz-Schraubendreher, 8-teilig

PROForm Phillips-, Pozidriv- and Slotted Screwdriver Inlay, 8 pieces

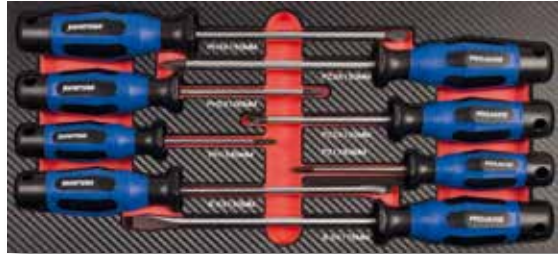

8
tlg./pcs.



395 x 186 x 35 mm



Art.-Nr./Art.-No.	tlg./pcs.	Inhalt/pcs.	L./L.	B./W.	H./H.
5999-065	8	PH 1 - 2 - 3 PZ 1 - 2 - 3 Schlitz 1,2 x 6,5 - 1,2 x 8,0			gemischt/mixed
5999-065E			395	186	35
Einlage leer/empty inlay					

5999-064 PROFESSIONAL PLUS STANDARD

PROForm Einlagesystem

Phillips- und Schlitz-Schraubendreher, 7-teilig

PROForm Phillips and Slotted Screwdriver Inlay, 7 pieces

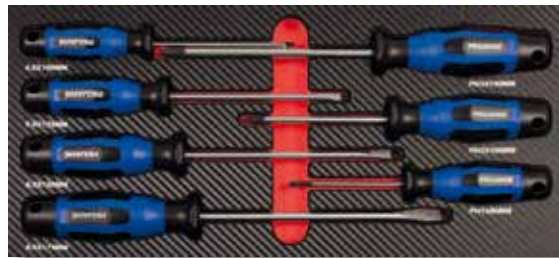

7
tlg./pcs.



395 x 186 x 35 mm



Art.-Nr./Art.-No.	tlg./pcs.	Inhalt/pcs.	L./L.	B./W.	H./H.
5999-064	7	PH 1 - 2 - 3 Schlitz 0,8 x 4,0 - 1,0 x 5,5 - 1,2 x 6,5 - 1,2 x 8,0			gemischt/mixed
5999-064E			395	186	35
Einlage leer/empty inlay					

5999-062 PROFESSIONAL PLUS STANDARD

PROForm Einlagesystem

Innen-TORX-Schraubendreher, 8-teilig

PROForm TX Screwdriver Inlay, 8 pieces

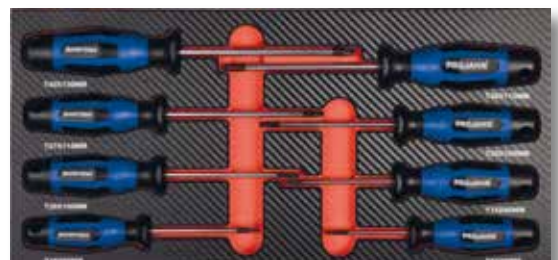

8
tlg./pcs.



395 x 186 x 35 mm



Art.-Nr./Art.-No.	tlg./pcs.	Inhalt/pcs.	L./L.	B./W.	H./H.
5999-062	8	T8 - T10 - T15 - T20 - T25 - T27 - T30 - T40 TX			
5999-062E			395	186	35
Einlage leer/empty inlay					

PROForm Werkstattwagen Einlagen

PROForm Inlays for Roller Cabinets

Art.-Gruppe 171
Article Group 171

5999-481 PROFESSIONAL PLUS STANDARD

PROForm Einlegesystem Schraubendreher, 10-teilig (Doppeleinlage)

PROForm Screwdriver Inlay, 10 pieces



10
tlg./pcs.

395 x 375 x 35 mm



Art.-Nr./Art.-No.	tlg./pcs.	Inhalt/pcs.	L./L.	B./W.	H./H.
5999-481	10	PH 1 - 2 - 3, Vergaser-Schraubendreher/Carburetor Screwdriver PH2, Schlitz/Slotted 0,5 x 3,0 / 0,8 x 4,0 / 1,0 x 5,5 / 1,2 x 6,5 / 1,2 x 8,0 mm, Vergaser-Schraubendreher/Carburetor Screwdriver 6,5 x 25 mm			
5999-48E			395	375	35 Einlage leer/empty inlay

5999-061 PROFESSIONAL PLUS STANDARD

PROForm Einlegesystem Phillips- und Schlitz-Schraubendreher mit durchgehender Klinge und Schlagkappe, 6-teilig

PROForm Phillips and slotted Go-Through
Blade Screwdriver with Hammering Cap Inlay, 6 pieces

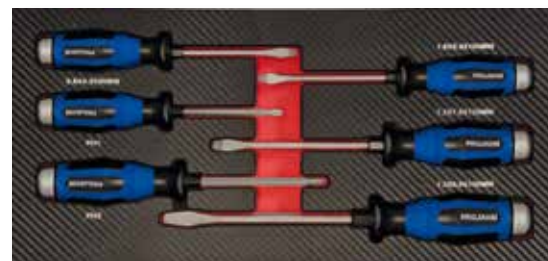

6
tlg./pcs.

395 x 186 x 35 mm



Art.-Nr./Art.-No.	tlg./pcs.	Inhalt/pcs.	L./L.	B./W.	H./H.
5999-061	6	PH 1 - 2 Schlitz 0,8 x 4,5 - 1,0 x 5,5 - 1,2 x 7,0 - 1,2 x 8,0			gemischt/mixed
5999-06E			395	186	35 Einlage leer/empty inlay

5999-071 PROFESSIONAL PLUS STANDARD

PROForm Einlegesystem Phillips-, Pozidriv- und Schlitz-Schraubendreher, 8-teilig

PROForm Phillips-, Pozidriv- and Slotted Screwdriver Inlay, 8 pieces



8
tlg./pcs.

395 x 186 x 35 mm



Art.-Nr./Art.-No.	tlg./pcs.	Inhalt/pcs.	L./L.	B./W.	H./H.
5999-071	8	PH 1 - 2 - 3 PZ 1 - 2 - 3 Schlitz 1,2 x 6,5 - 1,6 x 8,0			gemischt/mixed
5999-071E			395	186	35 Einlage leer/empty inlay

PROForm Werkstattwagen Einlagen

PROForm Inlays for Roller Cabinets

Art.-Gruppe 171
Article Group 171

5999-074 PROFESSIONAL PLUS STANDARD

PROForm Einlagesystem

Phillips-, Schlitz- und TORX-Schraubendreher, 8-teilig

PROForm Phillips, Slotted and TX Screwdriver Inlay, 8 pieces

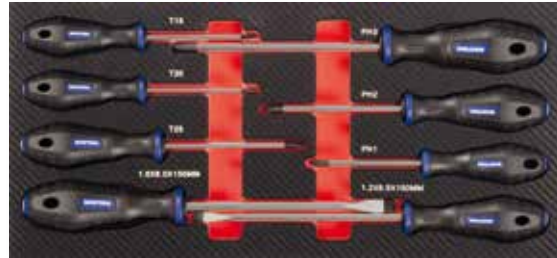

8
tlg./pcs.



395 x 186 x 35 mm



Art.-Nr./Art.-No.	tlg./pcs.	Inhalt/pcs.	L./L.	B./W.	H./H.
5999-074	8	PH 1 - 2 - 3, Schlitz 1,2 x 6,5 - 1,6 x 8,0, TX15 - 20 - 25			gemischt/mixed
5999-074E			395	186	35 Einlage leer/empty

5999-072 PROFESSIONAL PLUS STANDARD

PROForm Einlagesystem

Innen-TORX-Schraubendreher, 8-teilig

PROForm TX Screwdriver Inlay, 8 pieces

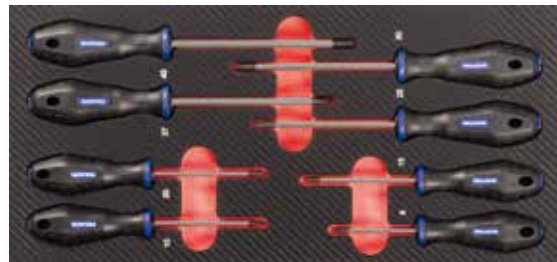

8
tlg./pcs.



395 x 186 x 35 mm



Art.-Nr./Art.-No.	tlg./pcs.	Inhalt/pcs.	L./L.	B./W.	H./H.
5999-072	8	T8 - T10 - T15 - T20 - T25 - T27 - T30 - T40			TX
5999-072E			395	186	35 Einlage leer/empty inlay

5999-073 PROFESSIONAL PLUS STANDARD

PROForm Einlagesystem

Innen-TORX-Schraubendreher mit stirnseitiger Bohrung, 8-teilig

PROForm Tamper TX Screwdriver Inlay, 8 pieces

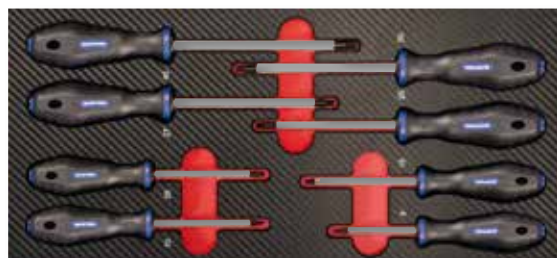

8
tlg./pcs.



395 x 186 x 35 mm



Art.-Nr./Art.-No.	tlg./pcs.	Inhalt/pcs.	L./L.	B./W.	H./H.
5999-073	8	T8 - T10 - T15 - T20 - T25 - T27 - T30 - T40			tamper TX
5999-072E			395	186	35 Einlage leer/empty inlay

PROForm Werkstattwagen Einlagen

PROForm Inlays for Roller Cabinets

Art.-Gruppe 171
Article Group 171

5999-355

PROFESSIONAL PLUS STANDARD

NEU/NEW

PROForm Einlagesystem

Sechskant T-Griff-Schraubendreher, 8-teilig

PROForm Hexagonal T-Handle Screwdriver Inlay, 8 pieces



8
tlg./pcs.



395 x 186 x 35 mm



Art.-Nr./Art.-No.	tlg./pcs.	Inhalt/pcs.	L./L.	B./W.	H./H.
5999-355	8	6 - 7 - 8 - 10 - 11 - 12 - 13 - 14 mm		Sechskant/Hexagonal	
5999-355E			395	186	35 Einlage leer/empty inlay

5999-341

PROFESSIONAL PLUS STANDARD

PROForm Einlagesystem

Kugelkopf T-Griff-Schraubendreher, 8-teilig

PROForm Ball End T-Handle Screwdriver Inlay, 8 pieces

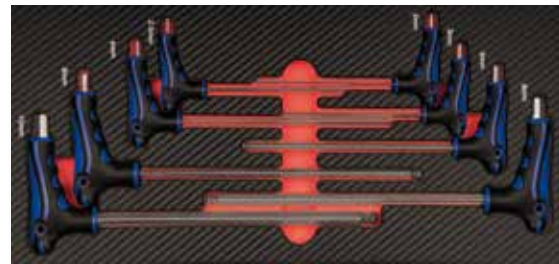

8
tlg./pcs.



395 x 186 x 35 mm



Art.-Nr./Art.-No.	tlg./pcs.	Inhalt/pcs.	L./L.	B./W.	H./H.
5999-341	8	2 - 2,5 - 3 - 4 - 5 - 6 - 8 - 10 mm		Kugelkopf/ball end	
5999-34E			395	186	35 Einlage leer/empty inlay

5999-351

PROFESSIONAL PLUS STANDARD

PROForm Einlagesystem

TX T-Griff-Schraubendreher, 9-teilig

PROForm TX T-Handle Screwdriver Inlay, 9 pieces

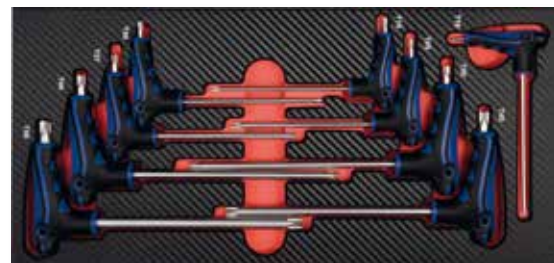

9
tlg./pcs.



395 x 186 x 35 mm



Art.-Nr./Art.-No.	tlg./pcs.	Inhalt/pcs.	L./L.	B./W.	H./H.
5999-351	9	T10 - T15 - T20 - T25 - T27 - T30 - T40 - T45 - T50		TX	
5999-35E			395	186	35 Einlage leer/empty inlay

PROForm Werkstattwagen Einlagen

PROForm Inlays for Roller Cabinets

Art.-Gruppe 171
Article Group 171

5999-092 PROFESSIONAL PLUS STANDARD

PROForm Einlagesystem

Sicherungsringzangen, 4-teilig

PROFORM Circlip Pliers Inlay, 4 pieces

Inhalt/Contents:

Sicherungsringzangen A2 - A21 - J2 - J21

Circlip Pliers A2 - A21 - J2 - J21

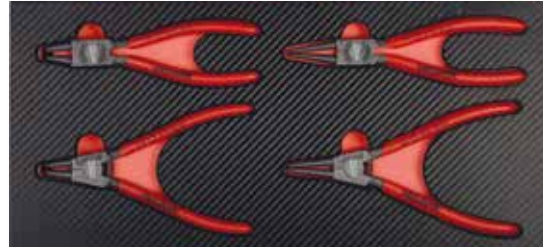

4
tlg./pcs.



395 x 186 x 35 mm

Art.-Nr./Art.-No.	tlg./pcs.	L./L.	B./W.	H./H.	
5999-092	4				
5999-092E		395	186	35	Einlage leer/empty inlay

5999-091 PROFESSIONAL PLUS STANDARD

PROForm Einlagesystem

Sicherungsringzangen, 4-teilig

PROFORM Circlip Pliers Inlay, 4 pieces

Inhalt/Contents:

Sicherungsringzangen A2 - A21 - J2 - J21

Circlip Pliers A2 - A21 - J2 - J21



4
tlg./pcs.



395 x 186 x 35 mm

Art.-Nr./Art.-No.	tlg./pcs.	L./L.	B./W.	H./H.	
5999-091	4				
5999-091E		395	186	35	Einlage leer/empty inlay

5999-161 PROFESSIONAL PLUS STANDARD

PROForm Einlagesystem Präzision, 45-teilig

PROForm Precision Tool Inlay, 45 pieces

Inhalt/Contents:

31-teilige Bit Box 4071, kurzer Bithalter 1/4" mit Schnellspannfutter, Elektronik-Flachzange, Elektronik-Rundzange, Elektronik-Kettenzange, Elektronik-Kettenzange 45°, Elektronik-Seitenschneider Präzisionssschraubendrehersatz 8-teilig mit 14 Schrauberklinken

31 pieces Bit ox 4071, Short Bit Screwdriver with Quick Release, Electronic Flat Nose Pliers, Electronic Round Nose Pliers, Electronic Chain Nose Pliers, Electronic Chain Nose Pliers 45°, Electronic Side Cutter, Precision Screwdriver Set with 14 Different Sizes/Tips



45
tlg./pcs.



395 x 186 x 35 mm

Art.-Nr./Art.-No.	tlg./pcs.	L./L.	B./W.	H./H.	
5999-161	45				
5999-161E		395	186	35	Einlage leer/empty inlay

PROForm Werkstattwagen Einlagen

PROForm Inlays for Roller Cabinets

Art.-Gruppe 171
Article Group 171

5999-082 PROFESSIONAL PLUS STANDARD

PROForm Einlegesystem Zangen, 4-teilig

PROForm Pliers Inlay, 4 pieces

Inhalt/Contents:

Kombizange 180 mm,
Seitenschneider 160 mm,
Telefonzange 205 mm,
Wasserpumpenzange 250 mm



4
tlg./pcs.



395 x 186 x 35 mm

Combination Pliers 180 mm, Side Cutter 160 mm,
Long Nose Pliers 205 mm, Waterpump Pliers 250 mm

Art.-Nr./Art.-No.	tlg./pcs.	L./L.	B./W.	H./H.	
5999-082	4				
5999-082E		395	186	35	Einlage leer/empty inlay

5999-461 PROFESSIONAL PLUS STANDARD

PROForm Einlegesystem Schlagwerkzeuge, 13-teilig

PROForm Hammer and Punch Inlay, 13 pieces

Inhalt/Contents:

Schlosserhammer 500 g, Splintentreiber Satz 2 – 8 mm,
5-teilig Schlagwerkzeuge-Satz inkl. Durchschlag, Körner,
Kreuz- und Flachmeißel, Cutter Messer mit einziehbarer Klinge,
Klingenbreite: 18 mm



13
tlg./pcs.



395 x 186 x 35 mm

Machinist Hammer 500 g, Pin Punches 2 – 8 mm,
5 pieces of Striking Tools including Taper and Center Punch, Bolt and Flat Chisel, Utility Knife with Rectangular Blade, Blade Width: 18 mm

Art.-Nr./Art.-No.	tlg./pcs.	L./L.	B./W.	H./H.	
5999-461	13				
5999-46E		395	186	35	Einlage leer/empty inlay

5999-101 PROFESSIONAL PLUS STANDARD

PROForm Einlegesystem Schlagwerkzeuge, 6-teilig

PROForm Hammer and Punch Inlay, 6 pieces

Inhalt/Contents:

Schlosserhammer 500 g, Kunststoffhammer 35 cm,
Splintentreiber 3 - 4 - 5 - 6 mm



6
tlg./pcs.



395 x 186 x 35 mm

Machinist Hammer 500 g, Dead-Blow Hammer 35 cm,
Pin Punches 3 - 4 - 5 - 6 mm

Art.-Nr./Art.-No.	tlg./pcs.	L./L.	B./W.	H./H.	
5999-101	6				
5999-10E		395	186	35	Einlage leer/empty inlay

PROForm Werkstattwagen Einlagen

PROForm Inlays for Roller Cabinets

Art.-Gruppe 171
Article Group 171

5999-451 PROFESSIONAL PLUS STANDARD

PROForm Einlegesystem VDE-Werkzeug, 13-teilig (Doppelseinlage)

PROForm VDE Screwdriver and VDE Pliers Inlay, 13 pieces (2/3-inlay)

Inhalt/Contents:

**VDE-Kombizange 180 mm, VDE-Seitenschneider 160 mm,
VDE-Kabelschneider 160 mm, VDE-Abisolierzange 160 mm,
VDE-Telefonzange 45° 200 mm, VDE-Telefonzange 200 mm,
Spannungsprüfer 3,5 x 90 mm,
VDE-Schraubendreher PH1, PH2, Schlitz 2,5 x 80 mm,
4,0 x 100 mm, 5,5 x 125 mm, 6,5 x 150 mm**

VDE Combination Pliers 180 mm, VDE Side Cutter 160 mm,
VDE Cable cutter 160 mm, VDE Wire Stripping Pliers 160 mm,
VDE Long nose pliers 45° 200 mm, VDE Long Nose Pliers 200 mm,
Voltage Tester 3,5 x 90 mm, VDE Screwdriver PH1, PH2,
VDE Slotted Screwdriver 2,5 x 80 mm,
4,0 x 100 mm, 5,5 x 125 mm, 6,5 x 150 mm

  **1000V**
EN 60900



13
tlg./pcs.



395 x 375 x 35 mm

Art.-Nr./Art.-No.	tlg./pcs.	L./L.	B./W.	H./H.	
5999-451	13				
5999-45E		395	375	35	Einlage leer/empty inlay

5999-471 PROFESSIONAL PLUS STANDARD

PROForm Einlegesystem Zangen, 6-teilig (Doppelseinlage)

PROForm Pliers Inlay, 6 pieces (2/3-inlay)

Inhalt/Contents:

**Flechtermetzze 260 mm,
Wasserpumpenzange 240 mm,
Gripzange 10"/250 mm, Telefonzange 205 mm,
Kombizange 180 mm, Seitenschneider 160 mm**

End Cutting Pliers 260 mm, Waterpump Wrench 240 mm,
Self Grip Pliers 10"/250 mm, Long Nose Pliers 205 mm,
Combination Pliers 180 mm, Side Cutter 160 mm



6
tlg./pcs.



395 x 375 x 35 mm

Art.-Nr./Art.-No.	tlg./pcs.	L./L.	B./W.	H./H.	
5999-471	6				
5999-47E		395	375	35	Einlage leer/empty inlay

PROForm Werkstattwagen Einlagen

PROForm Inlays for Roller Cabinets

Art.-Gruppe 171
Article Group 171

5999-361

PROFESSIONAL PLUS STANDARD

PROForm Einlegesystem Gewindeschneid-Werkzeug, 64-teilig (Doppeleinlage)

PROForm Tap and Die Tools Inlay, 64 pieces (2/3-inlay)

Inhalt/Contents:

Handgewindebohrer M3 - 4 - 5 - 6 - 8 - 10 - 12,
Schneideisen M3 - 4 - 5 - 6 - 8 - 10 - 12,
Windeisen verstellbar Nr. 1 – Nr. 2, Gewindegabel, Gewindegauge,
Schraubendreher, Werkzeughalter mit Knarre M5 - M12,
Schneideisenhalter 20x5 - 20x7 - 25x9 - 30x11 - 38x14 mm,
26 Stück Spiralbohrer HSS-G BASIC, 1 - 10,2 mm / 0,5 steigend,
inkl. Kernlochmaße

Hand Tap M3 - 4 - 5 - 6 - 8 - 10 - 12,

Circular Die M3 - 4 - 5 - 6 - 8 - 10 - 12,

Adjustable Tap Wrench No. 1 – No. 2, Tap Gauge,

Screwdriver, Tool-Holder with Ratchet M5 - M12,

Die Stock 20x5 - 20x7 - 25x9 - 30x11 - 38x14 mm,

HSS-G Twist Drill Bits BASIC, 1 - 10 mm / 0,5 Growing + 2,5 - 3,3 - 4,2 - 5,0 - 6,8 - 8,5 - 10,2 mm



64
tlg./pcs.

395 x 375 x 35 mm



Art.-Nr./Art.-No.	tlg./pcs.	L./L.	B./W.	H./H.	
5999-361	64				
5999-36E		395	375	35	Einlage leer/empty inlay

5999-181

PROFESSIONAL PLUS STANDARD

PROForm Einlegesystem Schneid- und Mess-Werkzeug, 27-teilig (Dreifacheinlage)

PROForm Cutting and Measuring Tools Inlay, 27 pieces (3/3-inlay)

Inhalt/Contents:

Säge mit 5 Ersatz-Sägeblättern,
Messer mit 10 Ersatz-Klingen,
3 Blechscheren,
Hebel Kraft-Seitenschneider 180 mm,
Beißzange 200 mm, Meßschieber,
Maßstab 1 m, Maßband 3 m,
Magnetheber, Taschenlampe

Hack Saw + 5 pieces Saw Blades,

Knife + 10 pieces Blades,

3 pieces Tinmans Shears,

Heavy Duty Side Cutter 180 mm, End Cutting Pliers 200 mm,

Vernier Caliper, Foldable Plastic Ruler 1m, Measuring Tape 3m, Magnetic Pick Up Tool, Flashlight



27
tlg./pcs.

395 x 560 x 35 mm



Art.-Nr./Art.-No.	tlg./pcs.	L./L.	B./W.	H./H.	
5999-181	27				
5999-18E		395	560	35	Einlage leer/empty inlay

PROForm Werkstattwagen Einlagen

PROForm Inlays for Roller Cabinets

Art.-Gruppe 171
Article Group 171

5999-331

PROFESSIONAL PLUS STANDARD

PROForm Einlegesystem Feilen, 5-teilig

PROForm File Inlay, 5 pieces

Inhalt/Contents:

**Flachfeile Hieb 2/200 mm, Halbrundfeile Hieb 2/200 mm,
Rundfeile Hieb 2/200 mm, Vierkantfeile Hieb 2/200 mm,
Dreikantfeile Hieb 2/200 mm**

Flat File Hieb 2/200mm, Half Round File Hieb 2/200mm,
Round File Hieb 2/200mm, Three Square File Hieb 2/200mm,
Square File Hieb 2/200mm

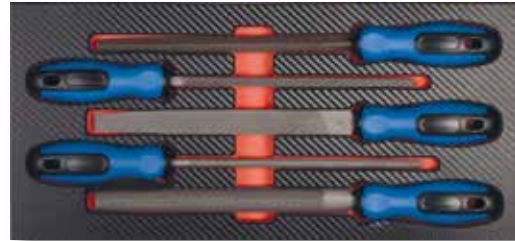

5
tlg./pcs.



395 x 186 x 35 mm

Art.-Nr./Art.-No.	tlg./pcs.	L./L.	B./W.	H./H.	
5999-331	5				
5999-33E		395	186	35	Einlage leer/empty inlay

5999-171

PROFESSIONAL PLUS STANDARD

PROForm Einlegesystem Gripzangen und Rollgabelschlüssel, 4-teilig

PROForm Rip Pliers and Adjustable Wrenches Inlay, 4 pieces

Inhalt/Contents:

**Rollgabelschlüssel 8"/200 mm, 12"/300 mm,
Gripzange 10"/250 mm,
Langbeck Klemmzange 150 mm**

Adjustable Wrenches 8"/200 mm, 12"/300 mm,
Self Grip Pliers 10"/250 mm,
Long Jaws Grip Pliers 150 mm



4
tlg./pcs.



395 x 186 x 35 mm

Art.-Nr./Art.-No.	tlg./pcs.	L./L.	B./W.	H./H.	
5999-171	4				
5999-17E		395	186	35	Einlage leer/empty inlay

5999-391 / 5999-392 / 5999-393

PROFESSIONAL PLUS STANDARD

Leereinlagen für Schrauben und andere Kleinteile

Empty Inlays for Screws and other Small Items



5999-391



5999-392



5999-393

395 x 186 x 35 mm

Art.-Nr./Art.-No.	tlg./pcs.	L./L.	B./W.	H./H.	
5999-391	6 Fächer/6 Compartments	395	186	35	Einlage leer/empty inlay
5999-392	5 Fächer/5 Compartments	395	186	35	Einlage leer/empty inlay
5999-393	7 Fächer/7 Compartments	395	186	35	Einlage leer/empty inlay

Bestückter Werkzeugkoffer »RedLine«, »BlackLine« oder »SuperBlue«

Sets for Tool Box »RedLine«, »BlackLine« or »SuperBlue«

Art.-Gruppe 172
Article Group 172

5902-01 / 5902-201 / 5902-501

PROFESSIONAL PLUS STANDARD

„Compact TS“

Werkzeugkoffer »RedLine«, »BlackLine« oder »SuperBlue«

bestückt mit 81 Werkzeugen in PROForm-Einlage

„Compact TS“ set for tool box »RedLine«, »BlackLine« or »SuperBlue« assembled with 81 tools in PROForm-inlay

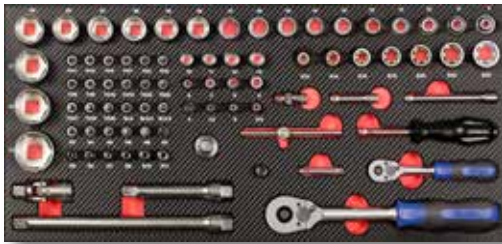

5999-211 269 x 568 x 35 mm



Art.-Nr./Art.-No.	Schubfächer/Drw.	L./L.	B./W.	H./H.	tlg./pcs.	
5902-01	6 »RedLine«	307	660	378	81	bestückt „COMPACT TS“
5902-201	6 »BlackLine«	307	660	378	81	bestückt „COMPACT TS“
5902-501	6 »SuperBlue«	307	660	378	81	bestückt „COMPACT TS“

5902-02 / 5902-202 / 5902-502

PROFESSIONAL PLUS STANDARD

„Compact XL“

Werkzeugkoffer »RedLine«, »BlackLine« oder »SuperBlue«

bestückt mit 155 Werkzeugen in PROForm-Einlagen

„Compact XL“ sets for tool box »RedLine«, »BlackLine« or »SuperBlue«, assembled with 155 tools in PROForm-inlay



5999-211 269 x 568 x 35 mm



5999-221 269 x 568 x 35 mm



5999-231 269 x 568 x 35 mm

Art.-Nr./Art.-No.	Schubfächer/Drw.	L./L.	B./W.	H./H.	tlg./pcs.	
5902-02	6 »RedLine«	307	660	378	155	bestückt „COMPACT XL“
5902-202	6 »BlackLine«	307	660	378	155	bestückt „COMPACT XL“
5902-502	6 »SuperBlue«	307	660	378	155	bestückt „COMPACT XL“

Einlagen zu Werkzeugkoffern

Inlays for Tool Boxes

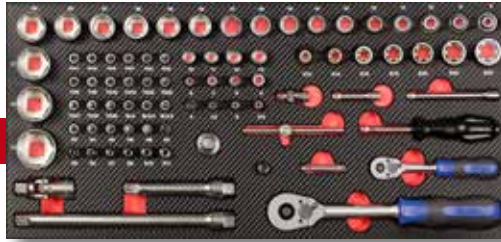

Art.-Gruppe 171
Article Group 171

PROFESSIONAL PLUS STANDARD

5999-211

269 x 568 x 35 mm

1/4" Inhalt/Contents:

**Knarre, Steckgriff, Gleitgriff,
Verlängerungen 50 + 100 mm, Stecknuss Bit Adapter 50 mm,
Kardangeln, Kupplungsstück für Bits,
Innen TX Nüsse E4 - 5 - 6 - 7 - 8 - 10 - 11,
6-kant Nüsse 4 - 4,5 - 5 - 5,5 - 6 - 7 - 8 - 9 - 10 - 11 - 12 - 13 mm,
Bit Nüsse: PH1 - 2 - 3, PZ1 - 2 - 3, Schlitz 4 - 5,5 - 6,5 mm,
TX8 - 9 - 10 - 15 - 20 - 25 - 27 - 30 - 40, Inbus 3 - 4 - 5 - 6 - 8 mm**

*Ratchet, Spinner Handle, Sliding T-Handle,
Extension Bars 50 + 100 mm, Socket Adapter 50 mm,
Universal Joint, Bit Adapter,
TX Sockets E4 - 5 - 6 - 7 - 8 - 10 - 11,
Sockets 4 - 4,5 - 5 - 5,5 - 6 - 7 - 8 - 9 - 10 - 11 - 12 - 13 mm,
Bit Sockets: PH1 - 2 - 3, PZ1 - 2 - 3, Slotted 4 - 5,5 - 6,5 mm,
TX8 - 9 - 10 - 15 - 20 - 25 - 27 - 30 - 40, Hex 3 - 4 - 5 - 6 - 8 mm*

1/2" Inhalt/Contents:

**Knarre, T-Gleitadapter, Verlängerungen 125 + 250 mm,
Kardangeln, 6-kant Nüsse 8 - 9 - 10 - 11 - 12 - 13 - 14 - 15 -
16 - 17 - 18 - 19 - 20 - 21 - 22 - 24 - 27 - 30 - 32 mm,
Innen-TX-Nüsse E12 - 14 - 16 - 18 - 20 - 22 - 24**

*Ratchet, T-Adapter, Extension Bars 125 + 250 mm,
Universal Joint, Sockets 8 - 9 - 10 - 11 - 12 - 13 - 14 - 15 -
16 - 17 - 18 - 19 - 20 - 21 - 22 - 24 - 27 - 30 - 32 mm,
TX Sockets E12 - 14 - 16 - 18 - 20 - 22 - 24*

Art.-Nr./Art.-No.	L./L.	B./W.	H./H.	tlg./pcs.	
5999-211	269	568	35	81	1/4" + 1/2" Einlage
5999-21E	269	568	35	1	Einlage leer

PROFESSIONAL PLUS STANDARD



5999-221

269 x 568 x 35 mm

Inhalt/Contents:

**Schraubendreher Phillips Nr. 1 + 2, Pozidriv Nr. 1 + 2,
Schlitz 0,5 x 3 x 75 mm, 0,8 x 4 x 100 mm,
1 x 5,5 x 125 mm, 1,2 x 6,5 x 150 mm, 1,6 x 8 x 150 mm,
Kombizange 180 mm, Seitenschneider 160 mm, Telefon-/
Radiozange 200 mm, Wasserpumpenzange 250 mm**

*Phillips Screwdriver No. 1 + 2, Pozidriv Screwdriver No. 1 + 2,
Slotted Screwdriver 0,5 x 3 x 75 mm, 0,8 x 4 x 100 mm,
1 x 5,5 x 125 mm, 1,2 x 6,5 x 150 mm, 1,6 x 8 x 150 mm,
Combination Plier 180 mm, Side Cutter 160 mm,
Long Nose Plier 200 mm, Waterpump Plier 250 mm*

Art.-Nr./Art.-No.	L./L.	B./W.	H./H.	tlg./pcs.	
5999-221	269	568	35	13	Schraubendreher- u. Zangen- Einlage
5999-22E	269	568	35	1	Einlage leer

PROFESSIONAL PLUS STANDARD



5999-231

269 x 568 x 35 mm

Inhalt/Contents:

**Gabelringschlüssel 8 - 9 - 10 - 11 - 12 - 13 - 14 -
15 - 16 - 17 - 18 - 19 mm, Schlosserhammer 500 g,
Splintreiber-Satz 2 - 3 - 4 - 5 - 6 - 8 mm,
Rollmeter 3 m, Universalmesser, Kugelkopf-Stiftschlüssel
Satz extra lang 2 - 10 mm im Drehhalter,
1/4" BIT STOP Box (32-tlg.)**

*Combination Wrenches 8 - 9 - 10 - 11 - 12 - 13 - 14 - 15 -
16 - 17 - 18 - 19 mm, Machinist Hammer 500 g, Pin Punch Set
2 - 3 - 4 - 5 - 6 - 8 mm, Measuring Tape 3 m, Knife, Ball Point
Keys Extra Long Version 2 to 10 mm, 1/4" BIT STOP Box (32 pieces)*

5999-231	269	568	35	61	Schlüssel- und Werkzeug-Einlage
5999-23E	269	568	35	1	Einlage leer

Sätze & Einzelteile

Socket Sets and Accessories

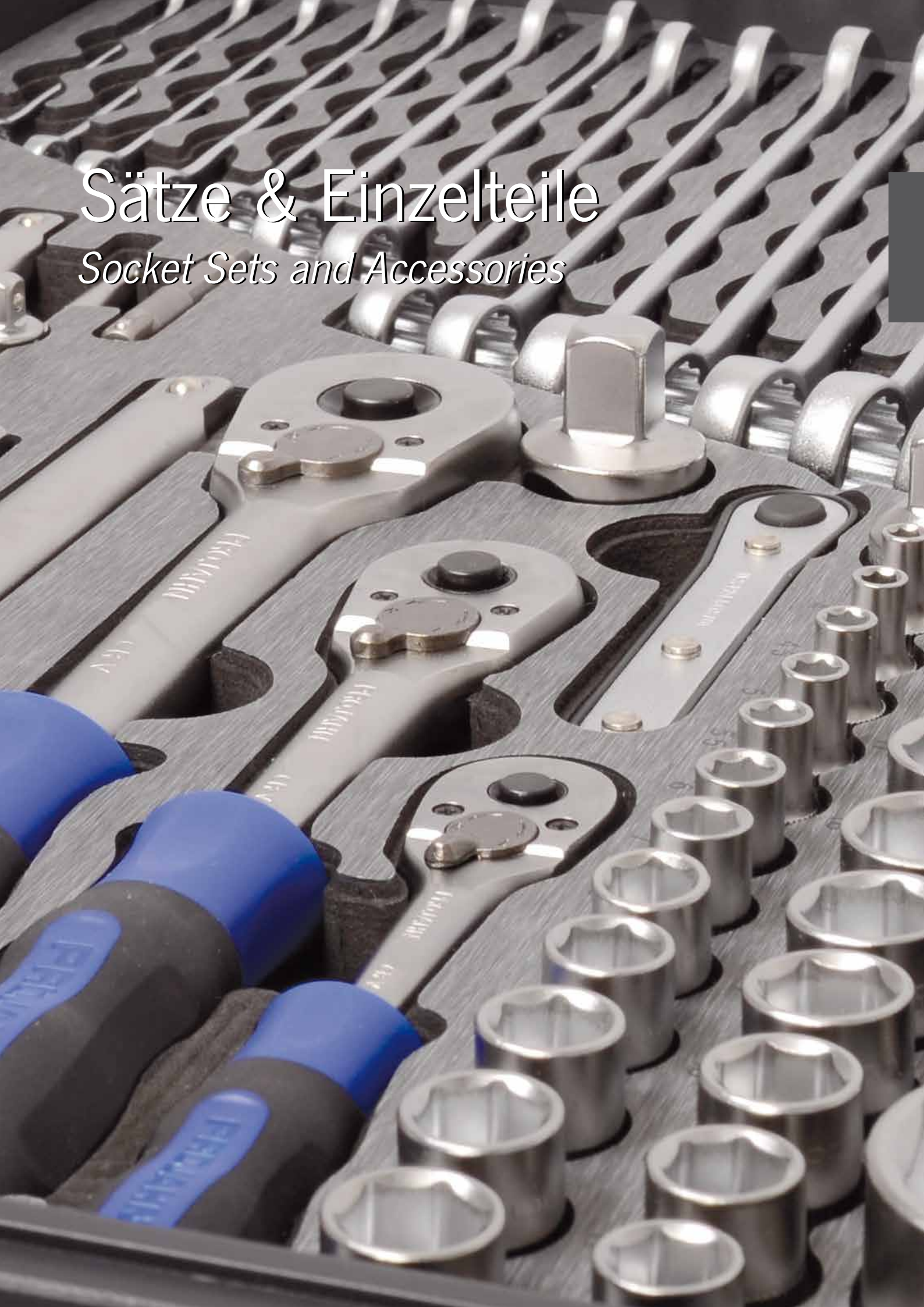

Qualitätsabstufungen im Katalog

Quality Levels in Catalogue

Sehr geehrter Kunde, PROJAHN liefert Ihnen stets eine gleichbleibend hohe Qualität. Um Ihnen die Suche nach dem für Ihre Anforderungen optimalen Werkzeug so einfach wie möglich zu machen, finden Sie über jedem Produkt das PROJAHN-Qualitätssiegel. Folgende Qualitätsstufen gliedern zukünftig das gesamte PROJAHN-Sortiment:

Dear Customer, PROJAHN always provides you with consistently high quality. To make the search for the optimal tool for your needs as easy as possible, you find the PROJAHN Quality Seal on each product. The following grades are dividing the entire PROJAHN range:

Höchste Qualitätsstufe / Highest Quality Level:

PROFESSIONAL PLUS STANDARD

Mittlere Qualitätsstufe / Medium Quality Level:

PROFESSIONAL **PLUS** STANDARD

Standard Qualitätsstufe / Standard Quality Level:

PROFESSIONAL PLUS **STANDARD**

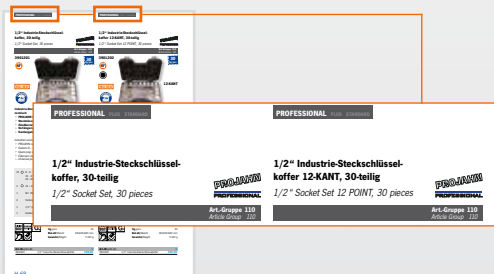

Leistung/
Performance

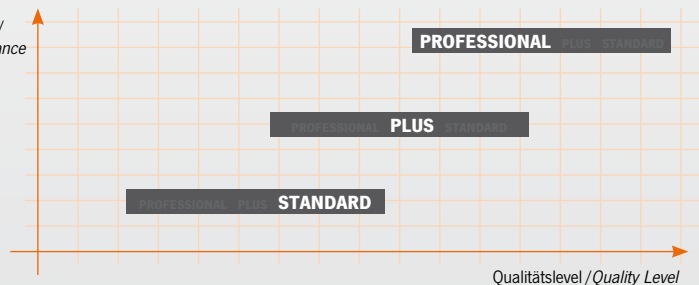

Qualitätslevel / Quality Level

PROFESSIONAL

- ▶ Höchstes Qualitätsniveau für ausgezeichnete Präzision
- ▶ Übertrifft DIN- und ISO-Normen
- ▶ Für härteste Anwendungen bei geringem Verschleiß
- ▶ Sehr lange Lebensdauer
- ▶ Hochwertigste Materialien, professionelles Oberflächen-Finish
- ▶ Kompromisslose Qualität für höchste Ansprüche

PLUS

- ▶ Sehr hohes Qualitätsniveau für präzises Arbeiten
- ▶ Qualität über DIN- und ISO-Normen
- ▶ Werkzeuge für schwierige Anforderungen
- ▶ Für problemlösungsorientierte Anwender
- ▶ Hochwertige Herstellung, ergonomisches Design

STANDARD

- ▶ Gute Markenqualität
- ▶ Sehr attraktiver Preis für Profi-Niveau
- ▶ Qualität für alle Standard-Anwendungen

PROFESSIONAL

- ▶ Highest level of quality for excellent precision
- ▶ Exceeds DIN and ISO standards
- ▶ For the hardest applications by low wear
- ▶ Very long life time
- ▶ High-quality materials, professional finish
- ▶ Uncompromising quality for highest demands

PLUS

- ▶ Very high level of quality for highest precision
- ▶ Quality higher than DIN and ISO standards
- ▶ Tools for difficult requirements
- ▶ For problem-solving users
- ▶ High-quality manufacturing, ergonomic design

STANDARD

- ▶ Good brand quality
- ▶ Attractive price-performance ratio
- ▶ Quality for all standard applications

Übersicht Werkzeugkoffer

Summary Tool Cases

1

Auf Seite / On Page	Qualität / Quality		Teile / Pieces	1/4"	3/8"	1/2"	3/4"	1"	Umschaltknarre / Ratchet Handle	Feinzahn-Umschaltknarre / Fine-Tooth Ratchet Handle	Durchsteck-Knarre / Go-Through Ratchet Handle	Tiefe Stecknüsse / Deep Sockets	Zündkerzen-Stecknüsse / Spark Plug Sockets	Schlagnüsse / Impact Sockets	Tiefe Schlagnüsse / Deep Impact Sockets	Stecknuss-Bits / Bit Sockets	Standard-Bits / Bits	Doppelgabelschlüssel / Double Open End Wrench	Ringgabelschlüssel / Combination Wrench	Doppelringschlüssel / Double Ring Wrench	Gear Tech Ratschenschlüssel / GearTech Ratchet Wrench	Winkeltiftschlüssel / Hex Keys	Schraubendreher, Steckgriff / Screwdriver, Spinner Handle	Zangen / Pliers	Hammer / Hammer	Säge / Saw	Wasserwaage / Spirit Level	Feile, Raspel / File, Rasp	Stechbeitel / Wood Chisel	
	PROFESSIONAL	PLUS																												
 1/4\" data-bbox="178 201 331 251"/> Art.-Nr./Art.No. 3901401 B x L x H/W x L x H: 260 x 160 x 60 mm Gewicht/Weight: 1.200 g	H 60	+	40	+					+		+																			
 1/4\" data-bbox="178 266 331 316"/> Art.-Nr./Art.No. 3901402 B x L x H/W x L x H: 260 x 160 x 60 mm Gewicht/Weight: 1.000 g	H 60	+	39	+					+		+																			
 1/4\" data-bbox="178 336 331 386"/> Art.-Nr./Art.No. 4008 B x L x H/W x L x H: 260 x 135 x 45 mm Gewicht/Weight: 1.360 g	H 61	+	23	+					+		+	+																		
 1/4\" data-bbox="178 401 331 451"/> Art.-Nr./Art.No. 4101 B x L x H/W x L x H: 225 x 125 x 45 mm Gewicht/Weight: 1.100 g	H 74	+	18	+					+		+																			
 1/4\" data-bbox="178 466 331 516"/> Art.-Nr./Art.No. 4016 B x L x H/W x L x H: 245 x 122 x 45 mm Gewicht/Weight: 1.200 g	H 76	+	25	+	+						+	+																		
 3D-Durchschraubknarrenkoffer/ 3D Go-Through Socket Set Art.-Nr./Art.No. 4017 B x L x H/W x L x H: 300 x 175 x 65 mm Gewicht/Weight: 1.760 g	H 76	+	17								+	+																		
 1/4\" data-bbox="178 601 331 651"/> Art.-Nr./Art.No. 394072 B x L x H/W x L x H: 188 x 110 x 40 mm Gewicht/Weight: 900 g	H 77	+	38	+					+		+																			
 1/4\" data-bbox="178 671 331 721"/> Art.-Nr./Art.No. 8601 B x L x H/W x L x H: 166 x 85 x 35 mm Gewicht/Weight: 660 g	H 77	+	28	+					+		+																			
 1/4\" data-bbox="178 741 331 791"/> Art.-Nr./Art.No. 4009 B x L x H/W x L x H: 245 x 128 x 40 mm Gewicht/Weight: 1.260 g	H 78	+	15	+					+		+																			
 1/4\" data-bbox="178 801 331 851"/> Art.-Nr./Art.No. 8651 B x L x H/W x L x H: 245 x 155 x 52 mm Gewicht/Weight: 1.250 g	H 79		46	+					+		+																			
 1/4\" data-bbox="178 866 331 916"/> Art.-Nr./Art.No. 8652 B x L x H/W x L x H: 245 x 155 x 52 mm Gewicht/Weight: 1.250 g	H 79		46	+					+		+																			

Übersicht Werkzeugkoffer

Summary Tool Cases

2

Auf Seite / On Page	Qualität / Quality		Teile / Pieces	1/4"	3/8"	1/2"	3/4"	1"	Unschaltknarre / Ratchet Handle	Feinzahn-Unschaltknarre / Fine-Tooth Ratchet Handle	Durchsteckknarre / Go-Through Ratchet Handle	Stecknüsse / Sockets	Tiefe Stecknüsse / Deep Sockets	Zündkerzen-Stecknüsse / Spark Plug Sockets	Schlagnüsse / Impact Sockets	Tiefe Schlagnüsse / Deep Impact Sockets	Stecknuss-Bits / Bit Sockets	Standard-Bits / Bits	Doppelgabelschlüssel / Double Open End Wrench	Ringgabelschlüssel / Combination Wrench	Doppelringsschlüssel / Double Ring Wrench	Gear Tech Ratschenschlüssel / Gear Tech Ratchet Wrench	Winkelstiftschlüssel / Hey/Keys	Schraubendreher, Steckgriff / Screwdriver, Spinner Handle	Zangen / Pliers	Hammer / Hammer	Säge / Saw	Wasservaaage / Spirit Level	Feile, Raspel / File, Rasp	Stechbeitel / Wood Chisel				
	PROFESSIONAL	PLUS																													STANDARD			
 1/4" Mini-Steckschlüsselkoffer / 1/4" Mini Socket Set Art.-Nr./Art.No. 4078 B x L x H/W x L x H: 160 x 83 x 33 mm Gewicht/Weight: 450 g	H 79		+	23	+				+				+																					
 3/8" Industrie-Steckschlüsselkoffer / 3/8" Industrial Socket Set Art.-Nr./Art.No. 3903801 B x L x H/W x L x H: 400 x 290 x 80 mm Gewicht/Weight: 5.500 g	H 62	+		76	+				+				+	+	+		+																	
 3/8" Industrie-Steckschlüsselkoffer / 3/8" Industrial Socket Set Art.-Nr./Art.No. 3903802 B x L x H/W x L x H: 360 x 260 x 75 mm Gewicht/Weight: 2.100 g	H 63	+		23	+				+				+	+																				
 3/8" Steckschlüsselkoffer US-Zoll / 3/8" Socket Set Inch Art.-Nr./Art.No. 4018 B x L x H/W x L x H: 390 x 180 x 50 mm Gewicht/Weight: 3.340 g	H 63	+		25	+				+				+	+	+																			
 3/8" Xi-on Steckschlüsselkoffer / 3/8" Xi-on Socket Set Art.-Nr./Art.No. 4111 B x L x H/W x L x H: 260 x 145 x 50 mm Gewicht/Weight: 2.000 g	H 74		+	17	+				+				+																					
 1/2" Industrie-Steckschlüsselkoffer / 1/2" Industrial Socket Set Art.-Nr./Art.No. 3901201 B x L x H/W x L x H: 400 x 290 x 80 mm Gewicht/Weight: 5.100 g	H 64	+		30	+				+				+	+	+																			
 1/2" Industrie-Steckschl. 12-KANT / 1/2" Industrial Socket Set 12 Point Art.-Nr./Art.No. 3901202 B x L x H/W x L x H: 400 x 290 x 80 mm Gewicht/Weight: 5.100 g	H 64	+		30	+				+				+	+	+																			
 1/2" Industrie-Steckschlüsselkoffer / 1/2" Industrial Socket Set Art.-Nr./Art.No. 3901203 B x L x H/W x L x H: 360 x 260 x 75 mm Gewicht/Weight: 3.500 g	H 65	+		20	+				+				+	+	+																			
 1/2" Steckschlüsselkoffer US-Zoll / 1/2" Socket Set Inch Art.-Nr./Art.No. 4028 B x L x H/W x L x H: 450 x 275 x 55 mm Gewicht/Weight: 6.540 g	H 65	+		28	+				+				+	+	+																			
 1/2" Xi-on Steckschlüsselkoffer / 1/2" Xi-on Socket Set Art.-Nr./Art.No. 4121 B x L x H/W x L x H: 450 x 195 x 55 mm Gewicht/Weight: 4.530 g	H 75		+	23	+				+				+	+	+																			
 1/2" Spiralprofil-Steckschlüsselkoffer / 1/2" Twist Socket Set Art.-Nr./Art.No. 3061 B x L x H/W x L x H: 160 x 120 x 50 mm Gewicht/Weight: 750 g	H 78		+	10	+								+																					











Übersicht Werkzeugkoffer Summary Tool Cases

3

Auf Seite / On Page	Qualität / Quality		Teile / Pieces	1/4"	3/8"	1/2"	3/4"	1"	Unschaltknarre / Ratchet Handle	Feinzahn-Unschaltknarre / Fine-Tooth Ratchet Handle	Durchsteck-Knarre / Go-Through Ratchet Handle	Stecknüsse / Sockets	Tiefe Stecknüsse / Deep Sockets	Zündkerzen-Stecknüsse / Spark Plug Sockets	Schlagnüsse / Impact Sockets	Tiefe Schlagnüsse / Deep Impact Sockets	Stecknuss-Bits / Bit Sockets	Standard-Bits / Bits	Doppelgabelschlüssel / Double Open End Wrench	Ringgabelschlüssel / Combination Wrench	Doppelringenschlüssel / Double Ring Wrench	Gear Tech Ratschenschlüssel / Gear Tech Ratchet Wrench	Winkelschlüssel / Hey Keys	Schraubendreher, Steckgriff / Screwdriver, Spinner Handle	Zangen / Pliers	Hammer / Hammer	Säge / Saw	Wasserwaage / Spirit Level	Feile, Raspel / File, Rasp	Stechbeitel / Wood Chisel	
	PROFESSIONAL	PLUS																													STANDARD
 1/2" Steckschlüsselkoffer/ 1/2" Socket Set Art.-Nr./Art.-No. 8661 B x L x H/W x L x H: 380 x 250 x 80 mm Gewicht/Weight: 3.500 g	H 80	+	21			+			+			+																			
 1/2" Steckschlüsselkoffer/ 1/2" Socket Set Art.-Nr./Art.-No. 8662 B x L x H/W x L x H: 380 x 250 x 80 mm Gewicht/Weight: 3.500 g	H 80	+	21			+			+			+																			
 1/2" Steckschlüsselkoffer/ 1/2" Socket Set Art.-Nr./Art.-No. 4027 B x L x H/W x L x H: 450 x 190 x 55 mm Gewicht/Weight: 4.600 g	H 80	+	22			+			+			+																			
 3/4" Industrie-Steckschlüsselkoffer/ 3/4" Industrial Socket Set Art.-Nr./Art.-No. 3903401 B x L x H/W x L x H: 550 x 380 x 115 mm Gewicht/Weight: 15.000 g	H 67	+	21					+	+			+																			
 1" Industrie-Steckschlüsselkoffer/ 1" Industrial Socket Set Art.-Nr./Art.-No. 2052 B x L x H/W x L x H: 730 x 320 x 150 mm Gewicht/Weight: 40.340 g	H 68	+	22					+	+			+																			
 1/2" Industrie-Steckschlüsselkoffer/ 1/2" Industrial Socket Set Art.-Nr./Art.-No. 3901204 B x L x H/W x L x H: 400 x 290 x 100 mm Gewicht/Weight: 6.800 g	H 66	+	45			+			+			+		+						+											
 1/4" + 1/2" Industrie-Steckschlüsselkoffer/ 1/4" + 1/2" Industrial Socket Set Art.-Nr./Art.-No. 3904201 B x L x H/W x L x H: 400 x 290 x 100 mm Gewicht/Weight: 6.700 g	H 70	+	91	+		+			+			+		+				+	+												
 1/4" + 1/2" Xi-on Steckschlüsselkoffer/ 1/4" + 1/2" Xi-on Socket Set Art.-Nr./Art.-No. 4131 B x L x H/W x L x H: 450 x 200 x 55 mm Gewicht/Weight: 5.200 g	H 75	+	54	+		+			+			+		+				+													
 1/4" + 1/2" Steckschlüsselkoffer/ 1/4" + 1/2" Socket Set Art.-Nr./Art.-No. 8653 B x L x H/W x L x H: 400 x 310 x 85 mm Gewicht/Weight: 7.000 g	H 81	+	108	+		+			+			+		+				+	+												
 1/4" + 1/2" Steckschlüsselkoffer/ 1/4" + 1/2" Socket Set Art.-Nr./Art.-No. 8654 B x L x H/W x L x H: 400 x 310 x 85 mm Gewicht/Weight: 7.000 g	H 81	+	108	+		+			+			+		+				+	+												

Übersicht Werkzeugkoffer





Summary Tool Cases

	Auf Seite / On Page	Qualität / Quality																																		
		PROFESSIONEL	PLUS	STANDARD	Teile / Pieces	1/4"	3/8"	1/2"	3/4"	1"	Unschaltknaure / Ratchet Handle	Feinzahn-Unschaltknaure / Fine-Tooth Ratchet Handle	Durchsteckknaure / Go-Through Ratchet Handle	Stecknüsse / Sockets	Tiefe Stecknüsse / Deep Sockets	Zündkerzen-Stecknüsse / Spark Plug Sockets	Schlagnüsse / Impact Sockets	Tiefe Schlagnüsse / Deep Impact Sockets	Stecknuss-Bits / Bit Sockets	Standard-Bits / Bits	Doppelgabelschlüssel / Double Open End Wrench	Ringgabelschlüssel / Combination Wrench	Doppelringeschlüssel / Double Ring Wrench	Gear Tech Ratschenschlüssel / Gear Tech Ratchet Wrench	Winkelstiftschlüssel / Hey/Keys	Schraubendreher + Steckgriff / Screwdriver + Spinner Handle	Zangen / Pliers	Hammer / Hammer	Säge / Saw	Wasservaage / Spirit Level	Feile, Raspel / File, Rasp	Stechbeitel / Wood Chisel				
 1/4" + 3/8" + 1/2" Steckschlüsselkoffer/ 1/4" + 3/8" + 1/2" Socket Set Art.-Nr./Art.No. 8663 B x L x H/W x L x H: 400 x 310 x 85 mm Gewicht/Weight: ca. 8.500 g	H 83		+	182	+	+	+			+			+	+	+						+	+				+	+									
 1/4" + 3/8" + 1/2" Steckschlüsselkoffer/ 1/4" + 3/8" + 1/2" Socket Set Art.-Nr./Art.No. 8664 B x L x H/W x L x H: 400 x 310 x 85 mm Gewicht/Weight: ca. 8.500 g	H 83			182	+	+	+			+			+	+	+						+	+				+	+									
 3/8" Universal Werkzeugkoffer/ 3/8" Universal Tool Set Art.-Nr./Art.No. 3903803 B x L x H/W x L x H: 550 x 380 x 115 mm Gewicht/Weight: 7.800 g	H 69	+		84		+				+			+		+						+	+				+	+	+	+	+	+	+	+			
 1/2" Universal Werkzeugkoffer/ 1/2" Universal Tool Set Art.-Nr./Art.No. 3901205 B x L x H/W x L x H: 460 x 350 x 90 mm Gewicht/Weight: 6.900 g	H 71	+		67		+				+			+		+						+	+				+	+	+	+	+	+	+				
 1/4" + 3/8" + 1/2" Industrie-Steckschl./ 1/4" + 3/8" + 1/2" Industrial Socket Set Art.-Nr./Art.No. 39048201 B x L x H/W x L x H: 550 x 380 x 115 mm Gewicht/Weight: 10.500 g	H 72	+		122	+	+	+			+			+								+	+				+	+	+	+	+	+	+				
 1/4" + 3/8" + 1/2" Industrie-Steckschlüsselk./ 1/4" + 3/8" + 1/2" Industrial Socket Set Art.-Nr./Art.No. 39048202 B x L x H/W x L x H: 550 x 380 x 115 mm Gewicht/Weight: 13.500 g	H 73	+		195	+	+	+			+			+	+	+	+	+	+	+		+	+				+	+									
 1/4" + 1/2" Werkzeugkoffer/ 1/4" + 1/2" Tool Set Art.-Nr./Art.No. 8655 B x L x H/W x L x H: 420 x 285 x 85 mm Gewicht/Weight: 6.000 g	H 82		+	91	+	+				+			+								+	+				+	+	+	+	+	+	+				
 1/4" + 1/2" Werkzeugkoffer/ 1/4" + 1/2" Tool Set Art.-Nr./Art.No. 8656 B x L x H/W x L x H: 420 x 285 x 85 mm Gewicht/Weight: 6.000 g	H 82		+	91	+	+				+			+								+	+				+	+	+	+	+	+	+				
 1/2" Metall-Werkzeugkoffer/ 1/2" Metal Tool Set Art.-Nr./Art.No. 8688 B x L x H/W x L x H: 490 x 225 x 380 mm Gewicht/Weight: 13.500 g	H 84		+	84		+				+			+		+						+	+				+	+	+	+	+	+	+	+	+		
 1/4" + 1/2" Universal-Werkzeugtrolley/ 1/4" + 1/2" Universal Tool Trolley Art.-Nr./Art.No. 4963-01 B x L x H/W x L x H: 450 x 390 x 170 mm Gewicht/Weight: 17.500 g	H 86		+	130	+	+				+			+								+	+				+	+	+	+	+	+	+	+	+	+	
 1/4" + 1/2" Universal-Werkzeugkoffer/ 1/4" + 1/2" Universal Tool Case Art.-Nr./Art.No. 8681 B x L x H/W x L x H: 460 x 330 x 145 mm Gewicht/Weight: 12.240 g	H 85		+	149	+	+				+			+								+	+				+	+	+	+	+	+	+	+	+	+	

Übersicht Werkzeugkoffer

Summary Tool Cases

5

Auf Seite / On Page	Qualität / Quality																															
	PROFESSIONEL	PLUS	STANDARD	Teile / Pieces																												
				1/4"	3/8"	1/2"	3/4"	1"	Umschaltknarre / Ratchet Handle	Feinzahn-Umschaltknarre / Fine-Tooth Ratchet Handle	Durchsteck-Knarre / Go-Through Ratchet Handle	Stecknüsse / Sockets	Tiefe Stecknüsse / Deep Sockets	Zündkerzen-Stecknüsse / Spark Plug Sockets	Schlagnüsse / Impact Sockets	Tiefe Schlagnüsse / Deep Impact Sockets	Stecknuss-Bits / Bit Sockets	Standard-Bits / Bits	Doppelgabelschlüssel / Double Open End Wrench	Ringgabelschlüssel / Combination Wrench	Doppelringsschlüssel / Double Ring Wrench	Gear Tech Ratschenschlüssel / Gear Tech Ratchet Wrench	Winkelschlüssel / Hex Keys	Schraubendreher + Steckgriff / Screwdriver + Spinner Handle	Zangen / Pliers	Hammer / Hammer	Säge / Saw	Wasserrwaage / Spirit Level	Feile, Raspel / File, Rasp	Stechbeitel / Wood Chisel		
 <p>3/8" Universal-Werkzeugkoffer/ 3/8" Universal Tool Case Art.-Nr./Art.-No. 8682 B x L x H/W x L x H: 425 x 280 x 130 mm Gewicht/Weight: 9.400 g</p>	H 87	+	164	+					+		+							+	+				+	+	+	+	+	+	+	+	+	
 <p>1/4" + 1/2" Elektro-Werkzeugkoffer/ 1/4" + 1/2" Electrician Tool Case Art.-Nr./Art.-No. 8683 B x L x H/W x L x H: 460 x 330 x 145 mm Gewicht/Weight: 10.200 g</p>	H 89	+	128	+	+				+		+							+	+				+	+	+	+	+	+	+	+		
 <p>1/4" Schreiner-Werkzeugkoffer/ 1/4" Carpenter Tool Case Art.-Nr./Art.-No. 8684 B x L x H/W x L x H: 460 x 330 x 145 mm Gewicht/Weight: 9.060 g</p>	H 88	+	92	+														+	+				+	+	+	+	+	+	+	+		
 <p>1/2" Sanitär-Werkzeugkoffer/ 1/2" Plumber Tool Case Art.-Nr./Art.-No. 8685 B x L x H/W x L x H: 460 x 330 x 145 mm Gewicht/Weight: 12.760 g</p>	H 90	+	95	+	+				+		+							+	+				+	+	+	+	+	+	+	+		
 <p>1/4" Werkzeutasche/ 1/4" Tool Bag Art.-Nr./Art.-No. 8686 B x L x H/W x L x H: 340 x 440 x 250 mm Gewicht/Weight: 7.200 g</p>	H 91	+	106	+					+		+						+	+	+				+	+	+	+						



Profi-Qualität

Professional Quality

- ▶ **Höchstes Qualitätsniveau für anspruchsvolle Anwender**
- ▶ **Präzision und Belastbarkeit weit über DIN-/ISO-Normen**
- ▶ **Ergonomisch optimiertes Kofferdesign – 2K-Koffergriff und klar strukturierte Anordnung der Werkzeuge**
- ▶ **Optimiert auf Langlebigkeit für höchste Ansprüche**
- ▶ *Highest level of quality for demanding users*
- ▶ *Precision and durability far beyond DIN/ISO standards*
- ▶ *Ergonomically optimized design – 2K-handle and clearly structured arrangement of the tools*
- ▶ *Optimized for durability for highest demands*

Einzigartiges Produktportfolio

Unique Product Range

- ▶ **Breites Produktsortiment für verschiedenste Anwendungen**
- ▶ **14 professionelle Werkzeugkoffer optimiert für individuelle Ansprüche**
- ▶ **Innovative, zukunftsorientierte Werkzeugzusammenstellung**
- ▶ *Wide product range enables universal use*
- ▶ *14 professional tool sets optimized for individual requirements*
- ▶ *Innovative and future-oriented assortment of tools*

Exklusive Persönlichkeit

Exclusive Personality

- ▶ **Hochwertige, ausdrucksstarke Premium-Optik**
- ▶ **Langlebige und stabile Design-Metallverschlüsse**
- ▶ **Werkzeuge passgenau eingebettet in Schaumeinlagen mit attraktiver metallischer Oberflächenoptik**
- ▶ *High-quality, expressive premium-look*
- ▶ *Durable and stable design metal locks*
- ▶ *Tools perfectly embedded in foam insert with attractive metallic surface appearance*

Leistungstarker Service

Powerful Support

- ▶ **PROJAHN Qualitätsversprechen – 25 Jahre Garantie¹**
- ▶ **Alle Einzelteile problemlos nachbestellbar**
- ▶ **Inklusive Servicezertifikat**
- ▶ **Qualifizierte Produktberatung**
- ▶ *PROJAHN's promise of quality – 25 years warranty¹*
- ▶ *All individual parts easily orderable*
- ▶ *Including certificate of service*
- ▶ *Qualified product advice*

¹ Entsprechend unserer allgemeinen Garantiebedingungen
⁴ According to our general warranty conditions





Ergonomisches Design

Ergonomic Design

- ▶ **Sicherer Halt und ermüdungsfreies Arbeiten durch ergonomisch an die Hand angepasste Griffform**
- ▶ **2-Komponentenmaterial – bruchsicherer, stabiler Kern und griffige Ummantelung mit hoher Rutschhemmung**
- ▶ **Hoher Abgleitschutz durch spezielle Daumenmulden**
- ▶ **Geringere Belastung für Gelenke bei gleichzeitig höherem Drehmoment**
- ▶ **Leichte Einhandbedienung durch Schnelllöseknopf und Richtungsumschalter**
- ▶ *Secure grip and fatigue-free working due to ergonomically to the hand designed ratchet handle*
- ▶ *Two-component material – robust core combined with an ergonomic, slip-resistant surface*
- ▶ *High slip protection due to specially adapted thumb grips*
- ▶ *Less strain on joints combined with a higher torque*
- ▶ *Easy one-handed operation because of quick-release button and direction lever*

EINGETRAGENES DESIGN

REGISTERED DESIGN



Profi-Qualität

Professional Quality

- ▶ **Höchstes Qualitätsniveau für anspruchsvolle Anwender**
- ▶ **Präzision und Belastbarkeit weit über DIN-/ISO-Normen**
- ▶ **Hält extremen Drehmomenten bis 650 Nm stand²**
- ▶ **Leichtgängiger, hochpräziser Knarrenmechanismus**
- ▶ **Hohe Öl- und Säurebeständigkeit**
- ▶ *Highest level of quality for demanding users*
- ▶ *Precision and durability far beyond DIN/ISO standards*
- ▶ *Withstands extreme torques up to 650 Nm⁽²⁾*
- ▶ *Smooth-running, high-precision ratchet mechanism*
- ▶ *High oil and acid resistance*



Leistungsstarker Service

Powerful Support

- ▶ **PROJAHN Qualitätsversprechen – 25 Jahre Garantie¹**
- ▶ **Schneller Reparaturservice im Garantiefall**
- ▶ *PROJAHN's promise of quality – 25 years warranty¹*
- ▶ *Fast repair service during warranty time*



¹ Entsprechend unserer allgemeinen Garantiebedingungen / ¹ According to our general warranty conditions
² 1/2" PROJAHN-Umschaltknarre 39012900 / ² PROJAHN ratchet handle 39012900

1/4" Industrie-Steckschlüsselkoffer, 40-teilig

1/4" Industrial Socket Set, 40 pieces

PROJAHN
PROFESSIONAL

Art.-Gruppe 114
Article Group 114

3901401

1/4"

40
tlg./pcs.

GARANTIE
25
JAHRE



Industrie-Steckschlüsselkoffer mit 40 Werkzeugen, metrisch

- ▶ PROJAHN Umschaltknarre
- ▶ Stecknüsse 3,5 – 14 mm
- ▶ Bit-Schraubereinsätze für alle Schraubarbeiten
- ▶ Ergonomischer Steckgriff

Industrial socket set with 40 assorted tools, metric

- ▶ PROJAHN ratchet handle, reversible
- ▶ Sockets 3.5 – 14 mm
- ▶ Bit-sockets for all screws
- ▶ Ergonomical spinner handle

14	○	3.5 - 4 - 4.5 - 5 - 5.5 - 6 - 7 - 8 - 9 - 10 - 11 - 12 - 13 - 14 mm	
3	●	4 - 5.5 - 6.5 mm	
3	+	PH 1 - 2 - 3	
3	+	PZ 1 - 2 - 3	
5	●	3 - 4 - 5 - 6 - 8 mm	
6	⊙	T10 - 15 - 20 - 25 - 30 - 40	
1		Art. 39014900	
1		Steckgriff	
2		Verlängerung 50 + 100 mm	
1		Gleitgriff	
1		Kardangelenke	



Größe/Size 1/4"
tlg./pcs. 40
BxLxH/WxLxH 260x160x60 mm
Gewicht/Weight 1.200 g

1/4" Industrie-Steckschlüsselkoffer 39-teilig

1/4" Industrial Socket Set, 39 pieces

PROJAHN
PROFESSIONAL

Art.-Gruppe 114
Article Group 114

3901402

1/4"

39
tlg./pcs.

GARANTIE
25
JAHRE



Industrie-Steckschlüsselkoffer mit 39 Werkzeugen, metrisch

- ▶ PROJAHN Umschaltknarre, Stecknüsse 3,5 – 14 mm
- ▶ Bits für jeden Einsatz, Stecknuss-Bit-Adapter
- ▶ Magnetischer Bit-Schraubendreher

Industrial socket set with 39 assorted tools, metric

- ▶ PROJAHN ratchet handle, reversible, sockets 3.5 – 14 mm
- ▶ Bits for all screws, adapter-bit for socket
- ▶ Magnetic spinner handle

14	○	3.5 - 4 - 4.5 - 5 - 5.5 - 6 - 7 - 8 - 9 - 10 - 11 - 12 - 13 - 14 mm	
2	●	5.5 - 6.5 mm	
3	+	PH 1 - 2 - 3	
3	+	PZ 1 - 2 - 3	
5	●	3 - 4 - 5 - 6 - 8 mm	
6	⊙	T10 - 15 - 20 - 25 - 30 - 40	
1		Adapter 1/4" (Knarre) x 1/4" (Bit)	
1		Art. 39014900	
1		Magn. Bitschraubendreher	
1		Verlängerung 100 mm	
1		Kardangelenke	
1		1/4" Stecknuss-Bit-Adapter	



Größe/Size 1/4"
tlg./pcs. 39
BxLxH/WxLxH 260x160x60 mm
Gewicht/Weight 1.000 g

Art.-Nr./Art.-No.





3901401	1/4" Industrie-Steckschlüsselkoffer
3901402	1/4" Industrie-Steckschlüsselkoffer

1/4" Steckschlüsselkoffer,**23-teilig, US-Zoll***1/4" Socket Set, 23 pieces, Inch***PROJAHN**
PROFESSIONAL**Art.-Gruppe 114**
Article Group 114**4008****1/4"****23**
tlg./pcs.**GARANTIE**
25
JAHRE**Industrie-Steckschlüsselkoffer mit 23 Werkzeugen,
Zoll im Metallkoffer**

- ▶ **Industrieknarre**
- ▶ **Stecknüsse 3/16" – 1/2"**
- ▶ **Tiefe Stecknüsse 3/16" – 1/2"**

*Industrial socket set with 23 assorted tools,
inch in metal case*

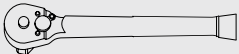
- ▶ *Industrial ratchet*
- ▶ *Sockets 3/16" – 1/2"*
- ▶ *Deep sockets 3/16" – 1/2"*

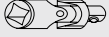
9	○ 3/16" - 7/32" - 1/4" - 9/32" - 5/16" - 11/32" - 3/8" - 7/16" - 1/2"	
9	○ 3/16" - 7/32" - 1/4" - 9/32" - 5/16" - 11/32" - 3/8" - 7/16" - 1/2"	
1	Art. 4208	
1	Steckgriff	
2	Verlängerung 2" + 3"	
1	Kardangelenk	

Größe/Size: 1/4" · **tlg./pcs.** 23 · **BxLxH/WxLxH:** 260x135x45 mm
Gewicht/Weight: 1.360 g

Art.-Nr./Art.-No.

4008 1/4" Steckschlüsselkoffer US-Zoll

3/8" Industrie-Steckschlüsselkoffer, 76-teilig

3/8" Socket Set, 76 pieces

PROJAHN
PROFESSIONAL

Art.-Gruppe 114
Article Group 114

3903801

3/8"

76
tlg./pcs.



Industrie-Steckschlüsselkoffer mit 76 Werkzeugen, metrisch

- ▶ PROJAHN Umschaltknarre
- ▶ Stecknüsse 6 – 24 mm
- ▶ Tiefe Stecknüsse 8 – 22 mm
- ▶ Bit-Stecknüsse für alle Schraubarbeiten

Industrial socket set with 76 assorted tools, metric

- ▶ PROJAHN ratchet handle, reversible
- ▶ Sockets 6 – 24 mm
- ▶ Deep sockets 8 – 22 mm
- ▶ Bit-sockets for all screws

19	○	6 - 7 - 8 - 9 - 10 - 11 - 12 - 13 - 14 - 15 - 16 - 17 - 18 - 19 - 20 - 21 - 22 - 23 - 24 mm		7	●	3 - 4 - 5 - 6 - 7 - 8 - 10 mm	
11	○	8 - 10 - 11 - 12 - 13 - 14 - 15 - 17 - 18 - 19 - 22 mm		10	⊕	T10 - 15 - 20 - 25 - 27 - 30 - 40 - 45 - 50 - 55	
2	○	16 + 21 mm		10	⊕	T10 - 15 - 20 - 25 - 27 - 30 - 40 - 45 - 50 - 55	
4	●	5.5 - 6.5 - 8 - 10 mm		1		1/2" (Knarre) x 3/8" (Nuss)	
4	⊕	PH 1 - 2 - 3 - 4		2		Verlängerungen 75 + 250 mm	
4	⊕	PZ 1 - 2 - 3 - 4		1		Kardangeln	
				1		Art. 39038900	



Größe/Size 3/8"
 tlg./pcs. 76
 BxLxH/WxLxH 400x290x80 mm
 Gewicht/Weight 5.600 g

Art.-Nr./Art.-No.	
3903801	3/8" Industrie-Steckschlüsselkoffer

3/8" Industrie-Steckschlüsselkoffer, 23-teilig

3/8" Socket Set, 23 pieces

PROJAHN
PROFESSIONAL

Art.-Gruppe 114
Article Group 114

3903802

3/8"

GARANTIE
25
JAHRE



23
tlg./pcs.

Industrie-Steckschlüsselkoffer mit 23 Werkzeugen, metrisch

- ▶ PROJAHN Umschaltknarre
- ▶ Stecknüsse 6 – 22 mm
- ▶ Zündkerzen Stecknüsse 16 + 21 mm
- ▶ Verlängerungen 75 + 250 mm

Industrial socket set with 23 assorted tools, metric

- ▶ PROJAHN ratchet handle, reversible
- ▶ Sockets 6 – 22 mm
- ▶ Spark plug sockets 16 + 21 mm
- ▶ Extension bars 75 + 250 mm

17	○	6 - 7 - 8 - 9 - 10 - 11 - 12 - 13 - 14 - 15 - 16 - 17 - 18 - 19 - 20 - 21 - 22 mm	
2	○	16 + 21 mm	
1		Art. 39038900	
2		Verlängerungen 75 + 250 mm	
1		1/2" (Knarre) x 3/8" (Nuss)	



Größe/Size 3/8"
tlg./pcs. 23
BxLxH/WxLxH 360x260x75 mm
Gewicht/Weight 2.100 g

Art.-Nr./Art.-No.

3903802 3/8" Industrie-Steckschlüsselkoffer

3/8" Steckschlüsselkoffer, 25-teilig, US-Zoll

3/8" Socket Set, 25 pieces, Inch

PROJAHN
PROFESSIONAL

Art.-Gruppe 114
Article Group 114

4018

3/8"

GARANTIE
25
JAHRE



25
tlg./pcs.

Industrie-Steckschlüsselkoffer mit 25 Werkzeugen, Zoll, im Metallkoffer

Industrial socket set with 25 assorted tools, inch, in metal case

10	○	5/16" - 3/8" - 7/16" - 1/2" - 9/16" - 5/8" - 11/16" - 3/4" - 13/16" - 7/8"	
9	○	3/8" - 7/16" - 1/2" - 9/16" - 5/8" - 11/16" - 3/4" - 13/16" - 7/8"	
2	○	5/8" + 13/16"	
1		Art. 4218	
2		Verlängerungen 3" + 6"	
1		Kardangelenke	

Größe/Size: 3/8" · tlg./pcs. 25 · BxLxH/WxLxH: 390x180x50 mm
Gewicht/Weight: 3.340 g

Art.-Nr./Art.-No.

4018 3/8" Steckschlüsselkoffer US-Zoll

1/2" Industrie-Steckschlüsselkoffer, 30-teilig

1/2" Socket Set, 30 pieces

PROJAHN
PROFESSIONAL

Art.-Gruppe 114
Article Group 114

3901201

1/2"



30
tlg./pcs.



Industrie-Steckschlüsselkoffer mit 30 Werkzeugen, metrisch

- ▶ PROJAHN Umschaltknarre
- ▶ Stecknüsse 8 – 34 mm
- ▶ Zündkerzen Stecknüsse 16 + 21 mm
- ▶ Verlängerungen 125 + 250 mm
- ▶ Kardangelen

Industrial socket set with 30 assorted tools, metric

- ▶ PROJAHN ratchet handle, reversible
- ▶ Sockets 8 – 34 mm
- ▶ Spark plug sockets 16 + 21 mm
- ▶ Extension bars 125 + 250 mm
- ▶ Universal joint

23 8 - 9 - 10 - 11 - 12 - 13 - 14 - 15 - 16 - 17 - 18 - 19 - 20 - 21 - 22 - 23 - 24 - 26 - 27 - 28 - 30 - 32 - 34 mm

2 16 + 21 mm

1 Art. 39012900

2 Verlängerungen 125 + 250 mm

1 1/2" (Knarre) x 1/2" (Nuss)

1 Kardangelen



Größe/Size 1/2"
tlg./pcs. 30
BxLxH/WxLxH 400x290x80 mm
Gewicht/Weight 5.100 g

Art.-Nr./Art.-No.

3901201 1/2" Industrie-Steckschlüsselkoffer

1/2" Industrie-Steckschlüsselkoffer 12-KANT, 30-teilig

1/2" Socket Set 12 POINT, 30 pieces

PROJAHN
PROFESSIONAL

Art.-Gruppe 114
Article Group 114

3901202

1/2"



30
tlg./pcs.



12-KANT

Industrie-Steckschlüsselkoffer mit 30 Werkzeugen, metrisch 12-KANT

- ▶ PROJAHN Umschaltknarre
- ▶ Stecknüsse 8 – 34 mm
- ▶ Zündkerzen Stecknüsse 16 + 21 mm
- ▶ Verlängerungen 125 + 250 mm
- ▶ Kardangelen

Industrial socket set with 30 assorted tools, metric 12 POINT sockets

- ▶ PROJAHN ratchet handle, reversible
- ▶ Sockets 8 – 34 mm
- ▶ Spark plug sockets 16 + 21 mm
- ▶ Extension bars 125 + 250 mm
- ▶ Universal joint

23 8 - 9 - 10 - 11 - 12 - 13 - 14 - 15 - 16 - 17 - 18 - 19 - 20 - 21 - 22 - 23 - 24 - 26 - 27 - 28 - 30 - 32 - 34 mm

2 16 + 21 mm

1 Art. 39012900

2 Verlängerungen 125 + 250 mm

1 1/2" (Knarre) x 1/2" (Nuss)

1 Kardangelen



Größe/Size 1/2"
tlg./pcs. 30
BxLxH/WxLxH 400x290x80 mm
Gewicht/Weight 5.100 g

Art.-Nr./Art.-No.

3901202 1/2" Industrie-Steckschlüsselkoffer

1/2" Industrie-Steckschlüssel- koffer, 20-teilig

1/2" Socket Set, 20 pieces

PROJAHN
PROFESSIONAL

Art.-Gruppe 114
Article Group 114

3901203

1/2"

20
tlg./pcs.



Industrie-Steckschlüsselkoffer mit 20 Werkzeugen, metrisch

- ▶ PROJAHN Umschaltknarre
- ▶ Stecknüsse 10 – 32 mm
- ▶ Zündkerzen Stecknüsse 16 + 21 mm
- ▶ Verlängerungen 125 + 250 mm

Industrial socket set with 20 assorted tools, metric

- ▶ PROJAHN ratchet handle, reversible
- ▶ Sockets 10 – 32 mm
- ▶ Spark plug sockets 16 + 21 mm
- ▶ Extension bars 125 + 250 mm

14	○	10 - 11 - 12 - 13 - 14 - 15 - 17 - 18 - 19 - 22 - 24 - 27 - 30 - 32 mm	
2	○	16 + 21 mm	
1		Art. 39012900	
2		Verlängerungen 125 + 250 mm	
1		1/2" (Knarre) x 1/2" (Nuss)	



Größe/Size 1/2"
tlg./pcs. 20
BxLxH/WxLxH 360x260x75 mm
Gewicht/Weight 3.500 g

Art.-Nr./Art.-No.

3901203 1/2" Industrie-Steckschlüsselkoffer

1/2" Steckschlüsselkoffer, 28-teilig, US-Zoll

1/2" Socket Set, 28 pieces, Inch

PROJAHN
PROFESSIONAL

Art.-Gruppe 114
Article Group 114

4028

1/2"

28
tlg./pcs.



Industrie-Steckschlüssel Satz mit 28 Werkzeugen, Zoll, im Metallkoffer

- ▶ Industrieknarre
- ▶ Stecknüsse 7/16" – 1 1/4"
- ▶ Tiefe Stecknüsse von 15/16" – 1/2"

Industrial socket set with 28 assorted tools,
inch, in metal case

- ▶ Industrial ratchet
- ▶ Sockets 7/16" – 1 1/4"
- ▶ Deep sockets 15/16" – 1/2"

13	○	7/16" - 1/2" - 9/16" - 5/8" - 11/16" - 3/4" - 13/16" - 7/8" - 15/16" - 1" - 1 1/16" - 1 1/8" - 1 1/4"	
8	○	15/16" - 7/8" - 13/16" - 3/4" - 11/16" - 5/8" - 9/16" - 1/2"	
2		5/8" + 13/16"	
2		Verlängerungen 5" + 10"	
1		1/2" (Knarre) x 1/2" (Nuss)	
1		Kardangelenk	
1		Art. 4228	

Größe/Size 1/2"
tlg./pcs. 28
BxLxH/WxLxH 450x275x55 mm
Gewicht/Weight 6.540 g

Art.-Nr./Art.-No.

4028 1/2" Steckschlüsselkoffer US-Zoll

1/2" Industrie-Steckschlüsselkoffer mit Gabelringschlüsseln, 45-teilig

1/2" Socket Set with Combination Wrenches, 45 pieces



Art-Gruppe 114
Article Group 114

3901204

1/2"

45
tlg./pcs.



Industrie-Steckschlüsselkoffer mit 45 Werkzeugen

- ▶ PROJAHN Umschaltknarre
- ▶ Stecknüsse 8 – 34 mm
- ▶ Zündkerzen Stecknüsse 16 + 21 mm
- ▶ Verlängerungen 125 + 250 mm
- ▶ Ringgabelschlüssel 6 – 22 mm

Industrial socket set with 45 assorted tools

- ▶ PROJAHN ratchet handle, reversible
- ▶ Sockets 8 – 34 mm
- ▶ Spark plug sockets 16 + 21 mm
- ▶ Extension bars 125 + 250 mm
- ▶ Combination wrenches 6 – 22 mm

23	○ 8 - 9 - 10 - 11 - 12 - 13 - 14 - 15 - 16 - 17 - 18 - 19 - 20 - 21 - 22 - 23 - 24 - 26 - 27 - 28 - 30 - 32 - 34 mm		2	Verlängerungen 125 + 250 mm	
2	○ 16 + 21 mm		1	1/2" (Knarre) x 1/2" (Nuss)	
1	Art. 39012900		1	Kardangelen	
			15	6 - 7 - 8 - 9 - 10 - 11 - 12 - 13 - 14 - 15 - 16 - 17 - 18 - 19 - 22 mm	



Größe/Size 1/2"
 tlg./pcs. 45
 BxLxH/WxLxH 400x290x100 mm
 Gewicht/Weight 6.700 g

Art.-Nr./Art.-No.	
3901204	1/2" Industrie-Steckschlüsselkoffer

3/4" Industrie-Steckschlüsselkoffer, 21-teilig

3/4" Socket Set, 21 pieces

PROJAHN
PROFESSIONAL

Art.-Gruppe 114
Article Group 114

3903401

21
tlg./pcs.

3/4"



Industrie-Steckschlüsselkoffer mit 21 Werkzeugen, metrisch

- ▶ Umschaltknarre
- ▶ Stecknüsse 19 – 50 mm
- ▶ Schiebegriff mit Gleitstück
- ▶ Verlängerungen 100 + 200 + 400 mm

Socket set with 21 assorted tools, metric

- ▶ Ratchet
- ▶ Sockets 19 – 50 mm
- ▶ 1 sliding t-handle
- ▶ 3 extension bars

16	○	19 - 21 - 22 - 23 - 24 - 26 - 27 - 29 - 30 - 32 - 35 - 36 - 38 - 41 - 46 - 50 mm	
3		Verlängerungen 100, 200 + 400 mm	
1		Gleitgriff	
1		Art. 400001	

Größe/Size: 3/4" · tlg./pcs. 21 · BxLxH/WxLxH: 550x380x115 mm
Gewicht/Weight: 15.000 g

Art.-Nr./Art.-No.

3903401 3/4" Industrie-Steckschlüsselkoffer



Weitere PROForm-Werkstatteinlagen ab Seite /
More PROForm Inlays for Roller Cabinet from Page H 32

1" Industrie-Steckschlüsselkoffer, 22-teilig

1" Socket Set, 22 pieces

PROJAHN
PROFESSIONAL

Art-Gruppe 114
Article Group 114

2052



22
tlg./pcs.



Industrie-Steckschlüsselkoffer mit 22 Werkzeugen, metrisch

- ▶ Umschaltknarre
- ▶ Stecknüsse 36 – 80 mm
- ▶ Schiebegriff mit Gleitstück
- ▶ Verlängerungen 200 + 400 mm

Socket set with 22 assorted tools, metric

- ▶ Ratchet
- ▶ Sockets 36 –80 mm
- ▶ 1 sliding t-handle
- ▶ 2 extension bars

17	36 - 38 - 41 - 46 - 50 - 54 - 55 - 58 - 60 - 63 - 65 - 67 - 70 - 71 - 75 - 77 - 80 mm	
2	Verlängerungen 200 + 400 mm	
1	Gleitgelenk	
1	Griff für Gleitgelenk 560 mm	
1	Art. 500000	

Größe/Size: 1" · tlg./pcs. 22 · BxLxH/WxLxH: 730x320x150 mm
Gewicht/Weight: 40.340 g

Art.-Nr./Art.No. 2052 1" Industrie-Steckschlüsselkoffer



Weitere PROForm-Werkstatteinlagen ab Seite / More PROForm Inlays for Roller Cabinet from Page H 32

3/8" Universal Industrie-Werkzeugkoffer, 84-teilig

3/8" Universal Industrial Tool Set, 84 pieces

3903803

3/8"



Universal Industrie-Werkzeugkoffer mit 84 Werkzeugen, metrisch

- ▶ PROJAHN Umschaltknarre
- ▶ Stecknüsse 8 – 22 mm
- ▶ Ringgabelschlüssel 8 – 21 mm
- ▶ 31-teilige Bit-Box 1/4"
- ▶ Magnetisches Kugelkopf-Stiftschlüssel-Set 9-teilig

Universal industrial tool set with 84 assorted tools, metric

- ▶ PROJAHN ratchet handle, reversible
- ▶ Sockets 8 – 22 mm
- ▶ Combination wrenches 8 – 21 mm
- ▶ 31 pcs bit box 1/4"
- ▶ Magnetic ball end hex key set 9pcs

13	8 - 10 - 11 - 12 - 13 - 14 - 15 - 16 - 17 - 18 - 19 - 21 - 22 mm	3/8"		1	Wasserpumpenzange 250 mm	
2	16 + 21 mm			1	Kombizange 180 mm	
1	Kardangelenk			1	Seitenschneider 160 mm	
1	Verlängerung 150 mm			1	Universalmesser	
1	3/8" (Knarre) x 1/4" (Bit)			1	Metallsägebogen 300 mm	
1	Art. 39038900			1	Hammer 300 g	
3	4 - 5.5 - 6.5 mm	1/4"		1	1.0 x 5.5 x 125 mm	
5	PH1 - PH1 - PH2 - PH2 - PH3			1	1.6 x 8.0 x 150 mm	
5	PZ1 - PZ1 - PZ2 - PZ2 - PZ3			2	PH 1 / PH 2	
9	T8 - 9 - 10 - 15 - 20 - 25 - 27 - 30 - 40			1	PZ 2	
8	2 - 2.5 - 3 - 4 - 5 - 6 - 7 - 8 mm			1	110 bis/up to 250 V Spannungsprüfer	
1	Magn. Bit-Halter 60 mm			1	Teleskop-Magnetheber	
1	Magn. Bit-Schraubendreher			1	Maßband 3 m	
9	1.5 - 2 - 2.5 - 3 - 4 - 5 - 6 - 8 - 10 mm			10	8 - 9 - 10 - 11 - 12 - 13 - 14 - 17 - 19 - 21 mm	



Größe/Size 1/4" + 3/8"
 tlg./pcs. 84
 BxLxH/WxLxH 550x380x115 mm
 Gewicht/Weight 7.800 g

Art.-Nr./Art.-No. 3903803 3/8" Universal Werkzeugkoffer

1/4" + 1/2" Industrie-Steckschlüsselkoffer, 91-teilig

1/4" + 1/2" Socket Set, 91 pieces



Art-Gruppe 114
Article Group 114

3904201

1/4"

1/2"

91
tlg./pcs.



Industrie-Steckschlüsselkoffer mit 91 Werkzeugen, metrisch

- ▶ 2 PROJAHN Umschaltknarren 1/4" + 1/2"
- ▶ Stecknüsse 3,5 – 32 mm
- ▶ Tiefe Stecknüsse 6 – 19 mm
- ▶ Zündkerzen Stecknüsse 16 + 21 mm
- ▶ 1/4" Bit Stecknüsse für alle Schraubarbeiten
- ▶ Industrie-Bits 5/16" und 1/2" Adapter für alle Schraubarbeiten
- ▶ Verlängerungen 50 + 100 + 125 + 250 mm
- ▶ Kardangelenke

Industrial socket set with 91 assorted tools, metric

- ▶ 2 PROJAHN ratchet handles, reversible 1/4"+1/2"
- ▶ Sockets 3,5 – 32 mm
- ▶ Deep sockets 6 – 19 mm
- ▶ Spark plug sockets 16 + 21 mm
- ▶ Bit sockets 1/4" for all screws
- ▶ Industrial bits 5/16" and 1/2" adapter for all screws
- ▶ Extension bars 50 + 100 + 125 + 250 mm
- ▶ Universal joints

14	○ 3.5 - 4 - 4.5 - 5 - 5.5 - 6 - 7 - 8 - 9 - 10 - 11 - 12 - 13 - 14 mm	1/4"	
8	○ 6 - 7 - 8 - 9 - 10 - 11 - 12 - 13 mm		
3	● 4 - 5.5 - 6.5 mm		
3	⊕ PH 1 - 2 - 3		
3	⊕ PZ 1 - 2 - 3		
4	● 3 - 4 - 5 - 6 mm		
8	● T8 - 9 - 10 - 15 - 20 - 25 - 27 - 30		
1	Kardangelenke		
2	Verlängerungen 50 + 100 mm		
1	Gleitgriff		
1	Steckgriff		
1	Art. 39014900		

14	○ 10 - 13 - 15 - 16 - 17 - 18 - 19 - 20 - 21 - 22 - 24 - 27 - 30 - 32 mm	1/2"	
4	○ 14 - 15 - 17 - 19 mm		
3	⊕ T50 - 55 - 60		
2	○ 16 + 21 mm		
1	1/2" (Knarre) x 1/2" (Nuss)		
2	Verlängerungen 125 + 250 mm		
1	1/2" (Knarre) x 5/16" (Bit)		
1	Kardangelenk		
1	Art. 39012900		
4	● 6.5 - 8 - 10 - 12 mm	5/16"	
3	⊕ PH 2 - 3 - 4		
3	⊕ PZ 2 - 3 - 4		
3	● T30 - 40 - 45		



Größe/Size 1/4" + 1/2" + 5/16"
 tlg./pcs. 91
 BxLxH/WxLxH 400x290x100 mm
 Gewicht/Weight 6.700 g

Art.-Nr./Art.-No.	
3904201	1/4" + 1/2" Industrie-Steckschlüsselkoffer

1/2" Universal Industrie-Werkzeugkoffer, 67-teilig

1/2" Universal Industrial Tool Set, 67 pieces

3901205



Universal Industrie-Werkzeugkoffer mit 67 Werkzeugen, metrisch

- ▶ PROJAHN Umschaltknarre
- ▶ Stecknüsse 8 – 27 mm
- ▶ Zündkerzen-Stecknüsse 16 + 21 mm
- ▶ 31-teilige Bit-Box 1/4"
- ▶ Doppelgabelschlüssel, metrisch 6 – 22 mm
- ▶ Schlosserhammer 300 g
- ▶ Zangen mit 2-Komponenten-Griff
- ▶ Schraubendreher mit 2-Komponenten-Griff

Universal industrial tool set

- with 67 assorted tools, metric
- ▶ PROJAHN ratchet handles, reversible
- ▶ Sockets 8 – 27 mm
- ▶ Spark plug sockets 16 + 21 mm
- ▶ 31 pcs bit box 1/4"
- ▶ Double open end wrenches 6 – 22 mm
- ▶ Hammer 300 g
- ▶ Pliers with 2k-handle
- ▶ Screwdrivers with 2k-handle

3	4 - 5.5 - 6.5 mm	1/4"		2	5.5 x 1.0 - 8 x 1.6 mm	
5	PH1 - PH1 - PH2 - PH2 - PH3			1	PH 2	
5	PZ1 - PZ1 - PZ2 - PZ2 - PZ3			1	Magn. Bit-Schraubendreher	
9	T8 - 9 - 10 - 15 - 20 - 25 - 27 - 30 - 40			1	110 bis/up to 250 V Spannungsprüfer	
8	2 - 2.5 - 3 - 4 - 5 - 6 - 7 - 8 mm			1	1.2 x 6.5 x 38 mm	
1	Magn. Bit-Halter 60 mm			1	PH 2	
11	8 - 10 - 12 - 13 - 14 - 15 - 17 - 19 - 22 - 24 - 27 mm	1/2"		1	Wasserpumpenzange 250 mm	
2	16 + 21 mm			1	Kombizange 180 mm	
2	Verlängerungen 125 + 250 mm			1	Hammer 300 g	
1	Kardangelenk			8	6 x 7 - 8 x 9 - 10 x 11 - 12 x 13 - 14 x 15 - 16 x 17 - 18 x 19 - 20 x 22 mm	
1	1/2" (Knarre) x 1/2" (Nuss)					
1	Art. 39012900					



Größe/Size 1/4" + 1/2"
 tlg./pcs. 67
 BxLxH/WxLxH 460x350x90 mm
 Gewicht/Weight 6.900 g

Art.-Nr./Art.-No. 3901205 1/2" Universal Werkzeugkoffer

1/4" + 3/8" + 1/2" Universal Industrie-Steckschlüsselkoffer, 122-teilig

1/4" + 3/8" + 1/2" Universal Industrie Socket Set, 122 pieces



Art-Gruppe 114
Article Group 114

39048201

1/4"

3/8"

1/2"

122
tlg./pcs.



Universal Industrie-Steckschlüsselkoffer mit 122 Werkzeugen, metrisch

- ▶ 3 PROJAHN Umschaltknarren 1/4" + 3/8" + 1/2"
- ▶ Stecknüsse 4 – 32 mm
- ▶ Verlängerungen 50 + 75 + 100 + 125 + 150 + 250 mm
- ▶ Kugelpf Stiftschlüssel Satz 9-teilig, magnetisch
- ▶ Ringgabelschlüssel 6 – 22 mm
- ▶ 31-teilige BitBox 1/4"
- ▶ Kombizange, Seitenschneider, Wasserpumpenzange
- ▶ Sechs Schraubendreher + ein Spannungsprüfer

Universal industrial socket set with 122 assorted tools, metric

- ▶ PROJAHN ratchet handles, reversible 1/4" + 3/8" + 1/2"
- ▶ Sockets 4 – 32 mm
- ▶ Extension bars 50 + 75 + 100 + 125 + 150 + 250 mm
- ▶ Magnetic ball end hex key set 9pcs
- ▶ Combination wrenches 6 – 22 mm
- ▶ 31 pcs bit box 1/4"
- ▶ Pliers ▶ 6 screwdrivers and a voltage tester

<p>12 ○ 4 - 4.5 - 5 - 5.5 - 6 - 7 - 8 - 9 - 10 - 11 - 12 - 13 mm</p> <p>1 1/4" x 1/4"</p> <p>1 Magn. Bit-Halter 60 mm</p> <p>3 ● 4 - 5.5 - 6.5 mm</p> <p>8 ● 2 - 2.5 - 3 - 4 - 5 - 6 - 7 - 8 mm</p> <p>9 ⊕ T8 - 9 - 10 - 15 - 20 - 25 - 27 - 30 - 40</p> <p>5 ⊕ PH 1 - PH 1 - PH 2 - PH 2 - PH 3</p> <p>5 ⊕ PZ 1 - PZ 1 - PZ 2 - PZ 2 - PZ 3</p> <p>1 Kardangelen</p> <p>2 Verlängerungen 50 + 100 mm</p> <p>1 Magn. Bit-Schraubendreher</p> <p>1 Gleitgriff</p> <p>1 Art. 39014900</p> <p>1 Bit-Knarre, Art. 2700</p> <p>1 1/4" x 1/4"</p> <p>1 Steckgriff</p>	<p>1/4"</p>	<p>2 1/2" (Knarre) x 1/2" (Nuss)</p> <p>1/2" (Knarre) x 3/8" (Nuss)</p> <p>1 Kardangelen</p> <p>13 ○ 17 - 18 - 19 - 20 - 21 - 22 - 23 - 24 - 26 - 27 - 28 - 30 - 32 mm</p> <p>2 Verlängerungen 125 + 250 mm</p> <p>1 Art. 39012900</p> <p>1 Wasserpumpenzange 250 mm</p> <p>1 Kombizange 180 mm</p> <p>1 Seitenschneider 160 mm</p> <p>1 ● 1.0 x 5.5 x 125 mm</p> <p>1 ● 1.6 x 8.0 x 150 mm</p> <p>2 ⊕ PH1/PH2</p> <p>2 ⊕ PZ1/PZ2</p> <p>1 110 bis/up to 250 V Spannungsprüfer</p> <p>9 1.5 - 2 - 2.5 - 3 - 4 - 5 - 6 - 8 - 10 mm</p> <p>16 6 - 7 - 8 - 9 - 10 - 11 - 12 - 13 - 14 - 15 - 16 - 17 - 18 - 19 - 21 - 22 mm</p>	<p>1/2"</p>
<p>10 ○ 10 - 11 - 12 - 13 - 14 - 15 - 16 - 17 - 18 - 19 mm</p> <p>2 Verlängerungen 75 + 150 mm</p> <p>1 3/8" (Knarre) x 1/4" (Bit)</p> <p>1 Kardangelen</p> <p>1 Art. 39038900</p>	<p>3/8"</p>		



Größe/Size 1/4" + 3/8" + 1/2"
 tlg./pcs. 122
 BxLxH/WxLxH 550x380x115 mm
 Gewicht/Weight 10.500 g

Art.-Nr./Art.-No.	
39048201	1/4" + 3/8" + 1/2"
Industrie-Steckschlüsselkoffer	

1/4" + 3/8" + 1/2" Industrie-Steckschlüsselkoffer, 195-teilig

1/4" + 3/8" + 1/2" Socket Set, 195 pieces

Art.-Gruppe 114
Article Group 114

39048202

1/4"

3/8"

1/2"

195
tlg./pcs.



Industrie-Steckschlüsselkoffer mit 195 Werkzeugen, metrisch

- ▶ 3 PROJAHN Umschaltknarren 1/4" + 3/8" + 1/2"
- ▶ Stecknüsse 4 – 32 mm ▶ Tiefe Stecknüsse 6 – 22 mm
- ▶ Verlängerungen 50 + 75 + 100 + 125 + 150 + 250 mm
- ▶ Innen-TX-Stecknüsse E4 – E20
- ▶ Kugelkopf Stiftschlüssel Satz 9-teilig, magnetisch
- ▶ Ringgabelschlüssel 6 – 22 mm
- ▶ Bit-Stecknüsse für alle Schraubarbeiten
- ▶ Tiefe Schlagnüsse 16 – 22 mm

Industrial socket set with 195 assorted tools, metric

- ▶ PROJAHN ratchet handles, reversible 1/4" + 3/8" + 1/2"
- ▶ Sockets 4 – 32 mm ▶ Deep sockets 6 – 22 mm
- ▶ Extension bars 50 + 75 + 100 + 125 + 150 + 250 mm
- ▶ TX-sockets E4 – E20 ▶ Combination wrenches 6 – 22 mm
- ▶ Ball end hex key set 9pcs, magnetic ▶ Bit-sockets for all screws
- ▶ Deep impact sockets 16 – 22 mm

- | | | | | |
|----|---|--|------|--|
| 12 | ○ | 4 - 4.5 - 5 - 5.5 - 6 - 7 - 8 - 9 - 10 - 11 - 12 - 13 mm | 1/4" | |
| 4 | ○ | 6 - 7 - 8 - 9 mm | | |
| 3 | ● | 4 - 5.5 - 6.5 mm | | |
| 2 | + | PH 1 - 2 | | |
| 2 | + | PZ 1 - 2 | | |
| 4 | ● | 3 - 4 - 5 - 6 mm | | |
| 8 | ● | T8 - 9 - 10 - 15 - 20 - 25 - 27 - 30 | | |
| 1 | | 1/4" x 1/4" | | |
| 1 | | Bit-Halter 60 mm | | |
| 4 | ● | 3 - 4 - 5 - 6 mm | | |
| 7 | ⊕ | T10 - 15 - 20 - 25 - 27 - 30 - 40 | | |
| 3 | + | PH 1 - 2 - 3 | | |
| 3 | + | PZ 1 - 2 - 3 | | |
| 1 | | Kardangelenk | | |
| 2 | | Verlängerungen 50 + 100 mm | | |
| 1 | | Magn. Bit-Schraubendreher | | |
| 1 | | Steckgriff | | |
| 1 | | Art. 39014900 | | |
| 1 | | Bit-Knarre, Art. 2700 | | |
| 1 | | Gleitgriff | | |

- | | | | | |
|----|---|--|------|--|
| 10 | ○ | 10 - 11 - 12 - 13 - 14 - 15 - 16 - 17 - 18 - 19 mm | 3/8" | |
| 6 | ○ | 10 - 11 - 12 - 13 - 14 - 15 mm | | |
| 2 | ○ | 16 + 21 mm | | |
| 2 | | Kippverlängerung 75 und 150 mm | | |

- | | | | |
|----|---|---|--|
| 12 | ⊕ | E4 - 5 - 6 - 7 - 8 - 10 - 11 - 12 - 14 - 16 - 18 - 20 | |
| 1 | | 1/2" (Knarre) x 3/8" (Nuss) | |
| 1 | | 3/8" (Knarre) x 1/4" (Bit) | |
| 1 | | Kardangelenk | |
| 1 | | Art. 39038900 | |

- | | | | | |
|----|---|---|------|--|
| 1 | | 1/2" (Knarre) x 5/16" (Bit) | 1/2" | |
| 1 | | 1/2" (Knarre) x 1/2" (Nuss) | | |
| 1 | | Kardangelenk | | |
| 2 | | Kippverlängerung 125 + 250 mm | | |
| 13 | ○ | 17 - 18 - 19 - 20 - 21 - 22 - 23 - 24 - 26 - 27 - 28 - 30 - 32 mm | | |
| 4 | ○ | 17 - 18 - 19 - 22 mm | | |
| 6 | | Tiefe Schlag-Stecknuss 16 - 17 - 18 - 19 - 21 - 22 mm | | |
| 2 | | Sicherungsring und -stift für Schlagnüsse | | |
| 1 | | Art. 39012900 | | |

- | | | | | |
|----|---|--|-------|--|
| 3 | ● | 8 - 10 - 12 mm | 5/16" | |
| 4 | ● | 4 - 5 - 6 - 8 mm | | |
| 4 | + | PH 1 - 2 - 3 - 4 mm | | |
| 4 | + | PZ 1 - 2 - 3 - 4 mm | | |
| 4 | ● | M6 - 8 - 10 - 12 | | |
| 5 | ● | T25 - 30 - 40 - 45 - 50 | | |
| 9 | ⊕ | T10 - 15 - 20 - 25 - 27 - 30 - 40 - 45 - 50 | | |
| 8 | ⊕ | T15 - 20 - 25 - 27 - 30 - 40 - 45 - 50 | | |
| 9 | | 1.5 - 2 - 2.5 - 3 - 4 - 5 - 6 - 8 - 10 mm | | |
| 16 | | 6 - 7 - 8 - 9 - 10 - 11 - 12 - 13 - 14 - 15 - 16 - 17 - 18 - 19 - 21 - 22 mm | | |



Größe/Size: 1/4" + 3/8" + 1/2" · tlg./pcs. 195

BxLxH/WxLxH: 550x380x115 mm · Gewicht/Weight: 13.500 g

Art.-Nr./Art.No.

39048202

1/4" Xi-on Steckschlüsselkoffer, 18-teilig

1/4" Xi-on Socket Set, 18 pieces

Art.-Gruppe 110
Article Group 110

4101

1/4"



18
tlg./pcs.

Xi-on Steckschlüsselkoffer mit 18 Werkzeugen, metrisch

- ▶ Feinzahn-Umschaltknarre
- ▶ Xi-on Stecknüsse 4 – 13 mm
- ▶ Verlängerung 50 mm
- ▶ Kardangelen u.v.m.

Xi-on Socket Set with 18 assorted tools, metric

- ▶ Reversible Ratchet
- ▶ Xi-on sockets 4 – 13 mm
- ▶ Extension Bar 50 mm
- ▶ Universal Joint, etc.

MULTISTECKNUSS
Xi-on

12	○ 4 - 4,5 - 5 - 5,5 - 6 - 7 - 8 - 9 - 10 - 11 - 12 - 13 mm	1/4" Xi-on	
1	Verlängerung, 50 mm		
1	Art. 5205, 1/4" 72 Zahn		
1	Kardangelen		
1	Gleitgriff		
1	Steckgriff		
1	Austreiber		

Größe/Size: 1/4" · tlg./pcs. 18 · BxLxH/WxLxH 225x125x45 mm
Gewicht/Weight: 1.020 g

3/8" Xi-on Steckschlüsselkoffer, 17-teilig

3/8" Xi-on Socket Set, 17 pieces

Art.-Gruppe 110
Article Group 110

4111

3/8"



17
tlg./pcs.

Xi-on Steckschlüsselkoffer mit 17 Werkzeugen, metrisch

- ▶ Feinzahn-Umschaltknarre
- ▶ Xi-on Stecknüsse 8 – 19 mm
- ▶ Verlängerung 75 + 150 mm
- ▶ Kardangelen u.v.m.

Xi-on Socket Set with 17 assorted tools, metric

- ▶ Reversible Ratchet
- ▶ Xi-on sockets 8 – 19 mm
- ▶ Extension Bar 75 + 150 mm
- ▶ Universal Joint, etc.

MULTISTECKNUSS
Xi-on

11	○ 8 - 10 - 11 - 12 - 13 - 14 - 15 - 16 - 17 - 18 - 19 mm	3/8" Xi-on	
2	Verlängerungen, 75 + 150 mm		
1	Art. 5215, 3/8" 72 Zahn		
1	Kardangelen		
1	Gleitgriff		
1	Austreiber		

Größe/Size: 3/8" · tlg./pcs. 17 · BxLxH/WxLxH: 260x145x50 mm
Gewicht/Weight: 2.000 g

Art.-Nr./Art.-No.

4101 1/4" Xi-on Steckschlüsselkoffer

Art.-Nr./Art.-No.

4111 3/8" Xi-on Steckschlüsselkoffer

1/2" Xi-on Steckschlüsselkoffer, 23-teilig

1/2" Xi-on Socket Set, 23 pieces

Art.-Gruppe 110
Article Group 110

4121

1/2"



23
tlg./pcs.

Xi-on Steckschlüsselkoffer mit 23 Werkzeugen, metrisch

- ▶ Feinzahn-Umschaltknarre
- ▶ Xi-on Stecknüsse 10 – 32 mm
- ▶ Verlängerungen 125 + 250 mm
- ▶ Kardangelenk u.v.m.

Xi-on Socket Set with 23 assorted tools, metric

- ▶ Reversible Ratchet
- ▶ Xi-on sockets 10 – 32 mm
- ▶ Extension Bars 125 + 250 mm
- ▶ Universal Joint, etc.



15	○	10 - 11 - 12 - 13 - 14 - 15 - 16 - 17 - 18 - 19 - 22 - 24 - 27 - 30 - 32 mm	1/2" Xi-on	
2	○	16 + 21 mm		
2		Verlängerungen 125 + 250 mm		
1		Art. 5225, 1/2" 60 Zahn		
1		Kardangelenk		
1		Gleitgriffadapter		
1		Austreiber		

Größe/Size: 1/2" · tlg./pcs. 23 · BxLxH/WxLxH: 450x195x55 mm
Gewicht/Weight: 4.530 g

Art.-Nr./Art.-No.

4121	1/2" Xi-on Steckschlüsselkoffer
4131	1/4" + 1/2" Xi-on Steckschlüsselkoffer

1/4" + 1/2" Xi-on Steckschlüsselkoffer, 54-teilig

1/4" + 1/2" Xi-on Socket Set, 54 pieces

Art.-Gruppe 110
Article Group 110

4131

1/4"

1/2"



54
tlg./pcs.

Xi-on Steckschlüsselkoffer mit 54 Werkzeugen, metrisch

- ▶ 2 Feinzahn-Umschaltknarren
- ▶ Xi-on Stecknüsse 4 – 32 mm
- ▶ Verlängerungen 50 + 125 + 150 + 250 mm
- ▶ Kardangelenke u.v.m.

Xi-on Socket Set with 54 assorted tools, metric

- ▶ 2 Reversible Ratchets
- ▶ Xi-on sockets 4 – 32 mm
- ▶ Extension Bars 50 + 125 + 150 + 250 mm
- ▶ Universal Joints, etc.



11	○	4 - 4,5 - 5 - 5,5 - 6 - 7 - 8 - 9 - 10 - 11 - 13 mm	1/4" Xi-on	
2		Verlängerungen 50 + 150 mm		
1		Art. 5205, 1/4" 72 Zahn		
1		Kardangelenk		
1		Gleitgriffadapter		
1		Steckgriff		
1		Austreiber		
2	●	5,5 - 7 mm		
2	+	PH 1 - 2		
6	●	3 - 4 - 5 - 6 - 8 - 10		

15	○	10 - 11 - 12 - 13 - 14 - 15 - 17 - 18 - 19 - 21 - 22 - 24 - 27 - 30 - 32 mm	1/2" Xi-on	
2	○	16 + 21 mm		
2		Verlängerungen 125 + 250 mm		
1		Art. 5225, 1/2" 60 Zahn		
1		Kardangelenk		
1		Gleitgriffadapter		
4		1,27 - 1,5 - 2 - 2,5 mm		

Größe/Size: 1/4" + 1/2" · tlg./pcs. 54 · BxLxH/WxLxH: 450x200x55 mm
Gewicht/Weight: 5.200 g

1/4" + 3/8" Durchschraubknarrenkoffer, 25-teilig

1/4" + 3/8" Go-Through Socket Set, 25 pieces

Art.-Gruppe 110
Article Group 110

4016

1/4"

3/8"



25
tlg./pcs.

Durchschraubknarrenkoffer mit 25 Werkzeugen, metrisch

- ▶ 3/8" Durchgangsknarre
- ▶ 3/8" Durchgangsverlängerung 75 mm
- ▶ 3/8" Durchgangsnüsse 10 – 19 mm
- ▶ 1/4" Stecknüsse 4 – 14 mm
- ▶ 3/8" Nussadapter für 1/4" Nüsse

Go-Through socket set with 25 assorted tools, metric

- ▶ 3/8" go-through ratchet
- ▶ 3/8" go-through extension bar 75 mm
- ▶ 3/8" go-through sockets 10 – 19 mm
- ▶ 1/4" sockets 4 – 14 mm
- ▶ 3/8" adapter for 1/4" sockets

13	○	4 - 4,5 - 5 - 5,5 - 6 - 7 - 8 - 9 - 10 - 11 - 12 - 13 - 14 mm	1/4"	
9	○	10 - 11 - 12 - 13 - 14 - 15 - 16 - 17 - 19 mm	3/8"	
1		Art. 4016-01		
1		Verlängerung 75 mm		
1		3/8" (Knarre) x 1/4" (Nuss)		



Größe/Size 1/4" + 3/8"
 tlg./pcs. 25
 BxLxH/WxLxH 245x122x45 mm
 Gewicht/Weight 1.200 g

Art.-Nr./Art.-No.

4016 1/4" + 3/8" Durchsteckknarrenkoffer

GearTech Durchschraubknarrenkoffer, 17-teilig

GearTech Go-Through Socket Set, 17 pieces

Art.-Gruppe 110
Article Group 110

4017

17
tlg./pcs.



▶ 3D-GearTech-FLEX-Knarre ermöglicht Arbeiten in drei Dimensionen

- ▶ Ideal für Arbeiten an extrem unzugänglichen Stellen
- ▶ Flexibel: Durchgangsnüsse für metrische und zöllige Schrauben sowie für Schrauben mit TORX®E-Profil

- ▶ 3D-GearTech-Flex ratchet allows working in 3 dimensions
- ▶ Easy to use for very narrow spaces
- ▶ Flexible to use: Go-Through Sockets fits with metric and inch screws and also with screws with TORX®E-profile



13	○	10 - 11 - 12 - 13 - 14 - 15 - 16 - 17 - 18 - 19 - 21 - 22 - 24 mm	
1		3D-GearTech-Flex Art. 4017-01	
1		Verlängerung 80 mm	
1		Adapter 1/4"	
1		Adapter 3/8"	

Tlg./pcs. 17 · BxLxH/WxLxH: 300x175x65 mm

Gewicht/Weight: 1.760 g

Art.-Nr./Art.-No.

4017 GearTech Durchschraubknarrenkoffer

1/4" Mini-Steckschlüssel- und Bit-Box, 38-teilig*1/4" Mini Socket Set and Bit Box, 38 pieces*Art.-Gruppe 110
Article Group 110**394072****1/4"****38**
tlg./pcs.

- ▶ **Kombination aus Steckschlüsselsatz und Bit-Box**
 - ▶ **Schnell das passende Werkzeug für nahezu jede Anwendung**
 - ▶ **Übersichtliche Anordnung der Werkzeuge**
 - ▶ **Color-Bits: Dank Farbleitsystem immer schnell den richtigen Bit**
- ▶ Combination of Socket-Set and Bit-Box
 - ▶ Easy and fast accessibility of the tools
 - ▶ Clearly assembled tools
 - ▶ Color-Bits: very easy to find the right size, because of colored bits

- 10 Stecknüsse 5,5 - 6 - 7 - 8 - 9 - 10 - 11 - 12 - 13 - 14 mm
- 2 Verlängerungen 50 + 100 mm
- 1 Umschaltknarre 48-ZAHN
- 1 Kardangelenk
- 1 Steckgriff
- 1 Adapter 1/4" (Knarre) x 1/4" (Bit)
- 2 Schlitz (rot) 4,5 - 6,5 mm
- 4 Phillips (dunkelrot) PH1 - 2 - 2 - 3
- 4 Pozidriv (blau) PZ1 - 2 - 2 - 3
- 7 TORX® m. Bohr. (violett) TX10 - 15 - 20 - 25 - 27 - 30 - 40
- 4 Inbus (orange) 3 - 4 - 5 - 6 mm
- 1 Adapter 1/4" x 1/4"

Größe/Size: 1/4" · **tlg./pcs.** 38 · **BxLxH/WxLxH:** 188x110x40 mm
Gewicht/Weight: 900 g

Art.-Nr./Art.-No.

394072 1/4" Mini-Steckschlüssel- und Bit-Box

1/4" MultiFit Steckschlüsselkoffer, 28-teilig*1/4" MultiFit Socket Set, 28 pieces*Art.-Gruppe 112
Article Group 112**8601****1/4"****28**
tlg./pcs.

mit Feinzahn-Knarre, 72 Zahn

72 Teeth Ratchet

- ▶ **1 Schlüssel – 4 Schrauben**
MultiFit-Profil – Mit einem Steckschlüssel-Einsatz bis zu vier verschiedene Schrauben oder Muttern bearbeiten!
1 Socket – 4 Drives: With MultiFit profile you can even use only 1 socket for 4 kinds of drives!
- ▶ **6-kant, 12-kant, TORX® E-Profil und viele andere Zollgrößen**

MultiFit	6-kant	12-kant	Zoll	E-TX
4,0 mm	✓	✓	5/32"	E5
4,5 mm	✓	✓		E6
5,0 mm	✓	✓	3/16"	
5,5 mm	✓	✓		
6,0 mm	✓	✓		E8
7,0 mm	✓	✓	9/32"	
8,0 mm	✓	✓	5/16"	E10
9,0 mm	✓	✓	11/32"	
10,0 mm	✓	✓	3/8"	E12
11,0 mm	✓	✓	7/16"	E14
12,0 mm	✓	✓	15/32"	E16
13,0 mm	✓	✓	1/2"	
14,0 mm	✓	✓	9/16"	E18

- 13 4 - 4.5 - 5 - 5.5 - 6 - 7 - 8 - 9 - 10 - 11 - 12 - 13 - 14 mm
- 3 4 - 5 - 6 mm
- 3 PH 1 - 2 - 3
- 3 PZ 1 - 2 - 3
- 3 4 - 5 - 6 mm
- 1 1/4" Bit-Adapter
- 1 **72 Zahn, Art. 8603**
- 1 Verlängerung 50 mm





Größe/Size: 1/4" · **tlg./pcs.** 28 · **BxLxH/WxLxH:** 166x85x35 mm
Gewicht/Weight: 660 g

Art.-Nr./Art.-No.



8601 1/4" MultiFit Steckschlüsselkoffer

1/4" Steckschlüsselkoffer, 15-teilig*1/4" Socket Set, 15 pieces***Art.-Gruppe 110**
Article Group 110**4009****1/4"****15**
tlg./pcs.**Größe/Size:** 1/4" **tlg./pcs.:** 15 **BxLxH/WxLxH:** 245x128x40 mm
Gewicht/Weight: 1.260 g**Art.-Nr./Art.-No.**

4009 1/4" Steckschlüsselkoffer

**Steckschlüsselkoffer mit 15 Werkzeugen
inkl. Fingerratsche***Socket set with 15 assorted tools with finger-ratchet*12  4 - 4,5 - 5 - 5,5 - 6 - 7 - 8 - 9 -
10 - 11 - 12 - 13 mm 1 Verlängerung 195, 220, 245, 270, 295 oder 320 mm 1 Fingerratsche mit Auswurf, Art. 4283
quick release finger ratchet 1 T-Griff-Ratsche mit Auswurf, Art. 4284
T-handle quick release ratchet **1/2" Spiralprofil-Steckschlüsselkoffer, 10-teilig***1/2" Twist Socket Set, 10 pieces***Art.-Gruppe 182**
Article Group 182**3061****1/2"****10**
tlg./pcs.**Größe/Size:** 1/2" **tlg./pcs.:** 10 **BxLxH/WxLxH:** 160x120x50 mm
Gewicht/Weight: 750 g**Art.-Nr./Art.-No.**

3061 1/2" Spiralprofil-Steckschlüsselkoffer

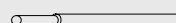
**Ideal für problemloses Ausdrehen von abgerundeten
Muttern und 6-kant Schrauben durch ein sich
verjüngendes Spezialprofil mit aggressiven Spiralnuten.***Special Sockets for opening damaged nuts.*9  10 - 11 - 12 - 13 - 14 - 15 - 16 - 17 - 19 mm
Länge: 34 mm 1 Verlängerung Ø 7,5 / 12 mm x L: 80 mm 

1/4" Mini-Steckschlüsselkoffer 23-teilig

1/4" Mini Socket Set, 23 pieces

Art.-Gruppe 110
Article Group 110

4078

1/4"

23
tlg./pcs.



Mini-Steckschlüsselkoffer mit 23 Werkzeugen, metrisch

- ▶ Miniknarre
- ▶ Stecknüsse 4 – 13 mm
- ▶ Bits für jeden Einsatz
- ▶ Verlängerung
- ▶ Bit-Adapter

Mini socket set with 23 assorted tools, metric

- ▶ Mini ratchet
- ▶ Sockets 4 – 13 mm
- ▶ Bits for all screws
- ▶ Extension bar
- ▶ Bit adapter

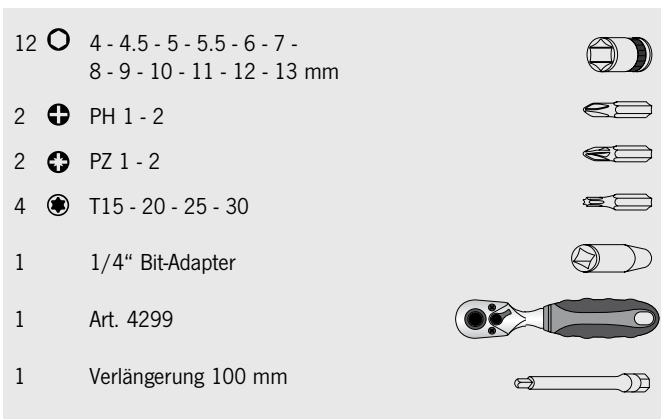

Größe/Size 1/4"
tlg./pcs. 23
BxLxH/WxLxH 160x83x33 mm
Gewicht/Weight 450 g

Art.-Nr./Art.-No.

4078	1/4" Mini-Steckschlüsselkoffer
8651	1/4" Steckschlüsselkoffer 48 Z
8652	1/4" Steckschlüsselkoffer 72 Z

1/4" Steckschlüsselkoffer, 46-teilig

1/4" Socket Set, 46 pieces

Art.-Gruppe 112
Article Group 112

1/4"

46
tlg./pcs.

8651
48-Zahn-
Knarre

8652
72-Zahn-
Knarre



Steckschlüsselkoffer mit 46 Werkzeugen, metrisch

- ▶ Mit Umschaltknarre 48 Zahn (Art.-Nr. 8651) oder mit Umschaltknarre 72 Zahn (Art.-Nr. 8652)
- ▶ Stecknüsse 4 – 14 mm

Socket set with 46 assorted tools, metric

- ▶ With ratchet, 48 teeth (Art.-No. 8651) or with ratchet, 72 teeth (Art.-No. 8652)
- ▶ Sockets 4 – 14 mm

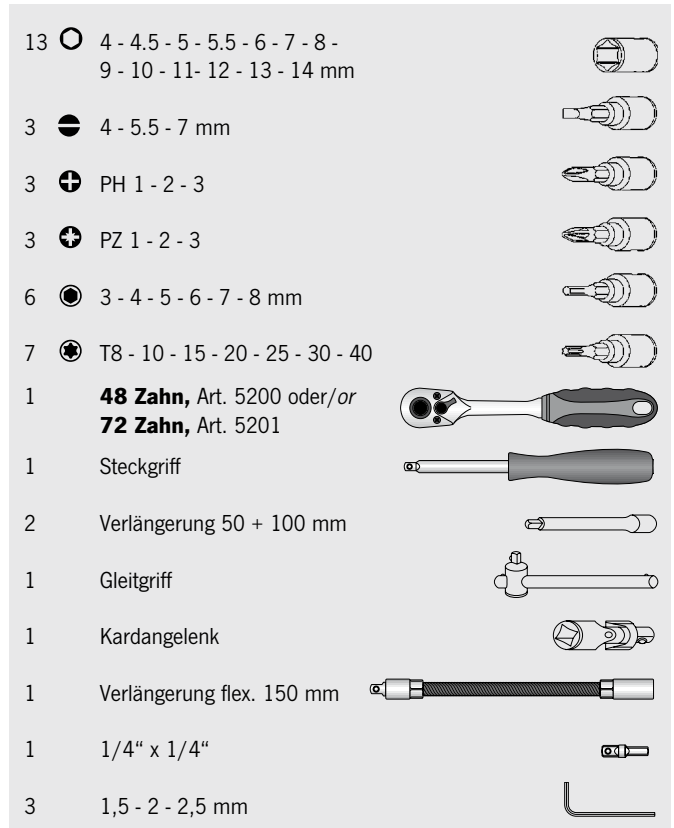

Größe/Size: 1/4" · **tlg./pcs.** 46 · **BxLxH/WxLxH:** 245x155x52 mm
Gewicht/Weight: 1.250 g

1/2" Steckschlüsselkoffer, 21-tlg.

1/2" Socket Set, 21 pieces



Art-Gruppe 112
Article Group 112

1/2" 21 tlg./pcs.



8661
48-Zahn-
Knarre

8662
72-Zahn-
Knarre

- Steckschlüsselkoffer mit 21 Werkzeugen, metrisch**
- ▶ Mit Umschaltknarre 48 Zahn (Art.-Nr. 8661) oder mit Umschaltknarre 72 Zahn (Art.-Nr. 8662)
 - ▶ Inkl. Zündkerzen-Stecknüsse 16 + 21 mm

Socket set with 21 assorted tools, metric

- ▶ With ratchet, 48 teeth (Art.-No. 8661) or with ratchet, 72 teeth (Art.-No. 8662)
- ▶ Incl. spark plug sockets 16 + 21 mm

- 15 ○ 10 - 11 - 12 - 13 - 14 - 15 - 16 - 17 - 18 - 19 - 22 - 24 - 27 - 30 - 32 mm
- 2 ○ 16 + 21 mm
- 1 **48 ZAHN**, Art. 5220 oder/or **72 ZAHN**, Art. 5221
- 1 Verlängerung 125 mm
- 1 Gleitgriff
- 1 Kardangelen

Größe/Size: 1/2" · **tlg./pcs.** 21 · **BxLxH/WxLxH:** 380x250x80 mm
Gewicht/Weight: 3.500 g

Art.-Nr./Art.-No.	
8661	1/2" proficraft Steckschlüsselkoffer 48 Z
8662	1/2" proficraft Steckschlüsselkoffer 72 Z

1/2" Steckschlüsselkoffer, 22-teilig

1/2" Socket Set, 22 pieces

Art-Gruppe 110
Article Group 110

4027

1/2"

22 tlg./pcs.



Steckschlüsselkoffer mit 22 Werkzeugen im hochwertigen Metallkoffer, metrisch

- ▶ Umschaltknarre 48 Zahn
- ▶ Stecknüsse 10 – 32 mm
- ▶ Zündkerzen Stecknüsse 16 + 21 mm
- ▶ Verlängerungen 125 + 250 mm

Industrial socket set with 22 assorted tools in metal case, metric

- ▶ Reversible ratchet 48 teeth
- ▶ Sockets 10 – 32 mm
- ▶ Spark plug sockets 16 + 21 mm
- ▶ Extension bars 125 + 250 mm

- 15 ○ 10 - 11 - 12 - 13 - 14 - 15 - 16 - 17 - 18 - 19 - 22 - 24 - 27 - 30 - 32 mm
- 2 ○ 16 + 21 mm
- 1 **48 Zahn**, Art. 5220
- 2 Verlängerungen 125 + 250 mm
- 1 3/8" (Knarre) x 1/2" (Nuss)
- 1 Kardangelen

Größe/Size: 1/2" · **tlg./pcs.** 22 · **BxLxH/WxLxH:** 450x190x55 mm
Gewicht/Weight: 4.600 g



Art.-Nr./Art.-No.	
4027	1/2" Steckschlüsselkoffer

1/4"+ 1/2" Steckschlüsselkoffer 108-teilig

1/4" + 1/2" Socket Set, 108 pieces



8653
48-Zahn-Knarren

8654
72-Zahn-Knarren

Steckschlüsselsatz mit 108 Werkzeugen, metrisch

- ▶ **2 Umschaltknarren 1/4" + 1/2", 48 ZAHN (8653) oder 2 Umschaltknarren 1/4" + 1/2", 72 ZAHN (8654)**
- ▶ **Stecknüsse 4 – 32 mm**
- ▶ **1/4" Bit Stecknüsse für alle Schraubarbeiten**

Socket set with 108 assorted tools, metric

- ▶ *2 ratchets 1/4" + 1/2", **48 TEETH (8653) or 2 ratchets 1/4" + 1/2", **72 TEETH (8654)*****
- ▶ *Sockets 4 – 32 mm*
- ▶ *Bit sockets 1/4" for all screws*

13	4 - 4.5 - 5 - 5.5 - 6 - 7 - 8 - 9 - 10 - 11 - 12 - 13 - 14 mm			17	10 - 11 - 12 - 13 - 14 - 15 - 16 - 17 - 18 - 19 - 20 - 21 - 22 - 24 - 27 - 30 - 32 mm		
8	6 - 7 - 8 - 9 - 10 - 11 - 12 - 13 mm			5	14 - 15 - 17 - 19 - 22 mm		
5	E4 - E5 - E6 - E7 - E8			8	E10 - E11 - E12 - E14 - E16 - E18 - E20 - E22		
3	4 - 5.5 - 6.5 mm			2	16 + 21 mm		
2	PH 1 - 2			1	3/8" (Knarre) x 1/2" (Nuss)		
2	PZ 1 - 2			2	Verlängerungen 125 + 250 mm		
4	3 - 4 - 5 - 6 mm			1	1/2" (Knarre) x 5/16" (Bit)		
7	TX8 - 10 - 15 - 20 - 25 - 27 - 30			1	Kardangelen		
1	Kardangelen			1	48 ZAHN , Art. 5220 oder/or 72 ZAHN , Art. 5221		
2	Verlängerungen 50 + 100 mm			3	8 - 10 - 12 mm		
1	Gleitgriff			2	PH 3 - 4		
1	Steckgriff			2	PZ 3 - 4		
1	48 ZAHN , Art. 5200 oder/or 72 ZAHN , Art. 5201			5	TX40 - 45 - 50 - 55 - 60		
3	1,5 - 2 - 2,5 mm			5	7 - 8 - 10 - 12 - 14 mm		

Größe/Size: 1/4" + 1/2" · **tlg./pcs.** 108

BxLxH/WxLxH: 400x310x85 mm

Gewicht/Weight: 7.000 g

Art.-Nr./Art.-No.

8653 1/4 + 1/2" Steckschlüsselk. 48 Z

8654 1/4 + 1/2" Steckschlüsselk. 72 Z

1/4" + 1/2" Werkzeugkoffer, 91-teilig

1/4" + 1/2" Tool Set, 91 pieces



Art.-Gruppe 112
Article Group 112

91
tlg./pcs.

1/4"
1/2"



8655*
48-Zahn-Knarren

8656*
72-Zahn-Knarren

Werkzeugkoffer mit 91 Werkzeugen, metrisch

- ▶ 2 Umschaltknarren 1/4" + 1/2", 48 ZAHN (8655) oder 2 Umschaltknarren 1/4" + 1/2", 72 ZAHN (8656)
- ▶ Stecknüsse 4 – 24 mm
- ▶ Ringgabelschlüssel 8 - 10 - 12 - 13 - 14 - 17 mm
- ▶ Bits für jeden Einsatz
- ▶ Schraubendreher und Zangen

Tool set with 91 assorted tools, metric

- ▶ 2 ratchets 1/4" + 1/2", **48 TEETH (8655)** or 2 ratchets 1/4" + 1/2", **72 TEETH (8656)**
- ▶ Sockets 4 – 24 mm
- ▶ Combination wrenches 8 - 10 - 12 - 13 - 14 - 17 mm
- ▶ Bits for all screws
- ▶ Screwdrivers and pliers

9	○ 4 - 5 - 6 - 7 - 8 - 9 - 10 - 11 - 12 mm	1/4"		1	Verlängerung 125 mm	
1	Verlängerung 75 mm			1	Kardangeln	
1	1/4" (Knarre) x 1/4" (Bit)			6	8 - 10 - 12 - 13 - 14 - 17 mm	
3	● 4.5 - 6.5 - 8 mm			9	1.5 - 2 - 2.5 - 3 - 4 - 5 - 6 - 8 - 10 mm	
3	⊕ PH 1 - 2 - 3			7	⊕ TX20 - 25 - 30 - 40 - 45 - 50 - 55	
3	⊕ PZ 1 - 2 - 3			6	● 4 - 5 - 6 - 8 - 10 - 12 mm	
7	⊗ TX10 - 15 - 20 - 25 - 27 - 30 - 40			1	Telefonzange 160 mm	
6	● 3 - 4 - 5 - 6 - 7 - 8 mm			1	Kombizange 180 mm	
1	48 ZAHN , Art. 5200 oder/or 72 ZAHN , Art. 5201			1	Wasserpumpenzange 250 mm	
1	Gleitgriff			3	● 8 x 150 mm - 6 x 100 mm - 6 x 38 mm	
1	Quergriff-Bitschraubendreher			1	⊕ PH 2 x 38 mm	
14	○ 8 - 10 - 11 - 12 - 13 - 14 - 15 - 16 - 17 - 18 - 19 - 21 - 22 - 24 mm	1/2"		2	⊕ PH 1 x 75 mm - PH 2 x 100 mm	
1	1/2" (Knarre) x 10 mm (Bit)					
1	48 ZAHN , Art. 5220 oder/or 72 ZAHN , Art. 5221					

Größe/Size: 1/4" + 1/2" · tlg./pcs. 91

BxLxH/WxLxH: 420x285x85 mm

Gewicht/Weight: 6.000 g

Art.-Nr./Art.-No.

8655* 1/4" + 1/2" Werkzeugkoffer 48 Z

8656* 1/4" + 1/2" Werkzeugkoffer 72 Z

*Lieferung nur solange der Vorrat reicht / *Delivery while stocks last

1/4" + 3/8" + 1/2" proficraft Steckschlüsselkoffer 182-teilig

1/4" + 3/8" + 1/2" proficraft Socket Set, 182 pieces

1/4"

3/8"

1/2"

8663
48-Zahn-Knarren

8664
72-Zahn-Knarren



Steckschlüssel-Satz mit 182 Werkzeugen, metrisch

182
tlg./pcs.

- ▶ 3 Umschaltknarren 1/4" + 3/8" + 1/2", **48 ZAHN (8663) oder**
- 3 Umschaltknarren 1/4" + 3/8" + 1/2", 72 ZAHN (8664)**
- ▶ **Stecknüsse 4 – 32 mm**
- ▶ **1/4" Bit-Stecknüsse für alle Schraubarbeiten**

Socket Set with 182 assorted Tools, metric

- ▶ 3 ratchets 1/4" + 3/8" + 1/2", **48 TEETH (8663) or**
- 3 ratchets 1/4" + 3/8" + 1/2", 72 TEETH (8664)**
- ▶ Sockets 4 – 32 mm
- ▶ Bit sockets 1/4" for all screws

- | | | | | |
|----|---|--|------|--|
| 13 | ○ | 4 - 4.5 - 5 - 5.5 - 6 - 7 - 8 - 9 - 10 - 11 - 12 - 13 - 14 mm | 1/4" | |
| 7 | ○ | 4 - 5 - 6 - 7 - 8 - 9 - 10 - mm | | |
| 5 | ⊕ | E4 - E5 - E6 - E7 - E8 | | |
| 4 | ● | 4 - 5.5 - 6.5 - 7 mm | | |
| 3 | ⊕ | PH 0 - 1 - 2 | | |
| 3 | ⊕ | PZ 0 - 1 - 2 | | |
| 4 | ● | 3 - 4 - 5 - 6 mm | | |
| 8 | ⊕ | T8 - T9 - T10 - T15 - T20 - T25 - T27 - T30 | | |
| 8 | ⊕ | T8 - T9 - T10 - T15 - T20 - T25 - T27 - T30 | | |
| 1 | | Kardangelen | | |
| 2 | | Verlängerungen 50 + 100 mm | | |
| 1 | | Gleitgriff | | |
| 1 | | Steckgriff | | |
| 1 | | 48 ZAHN, Art. 5200 oder/or
72 ZAHN, Art. 5201 | | |
| 4 | ● | 3 - 4 - 5,5 - 6 mm | | |
| 5 | ⊕ | PH 0 - 1 - 2 - 2 - 3 mm | | |
| 5 | ⊕ | PZ 0 - 1 - 2 - 2 - 3 mm | | |
| 10 | ⊕ | TX10 - 10 - 15 - 20 - 20 - 25 - 25 - 27 - 30 - 40 | | |
| 6 | ● | 2 - 2,5 - 3 - 4 - 5 - 6 | | |
| 1 | | 1/4" (Knarre) x 1/4" (Bit) | | |

- | | | | | | |
|----|---|---|-------|------|--|
| 3 | ● | 8 - 10 - 12 mm | 5/16" | | |
| 2 | ⊕ | PH 3 - 4 mm | | | |
| 2 | ⊕ | PZ 3 - 4 mm | | | |
| 6 | ⊕ | TX40 - 45 - 50 - 55 - 60 - 70 mm | | | |
| 6 | ⊕ | TX40 - 45 - 50 - 55 - 60 - 70 mm | | | |
| 5 | ● | 7 - 8 - 10 - 12 - 14 mm | | | |
| 10 | ○ | 10 - 11 - 12 - 13 - 14 - 15 - 16 - 17 - 18 - 19 mm | 3/8" | | |
| 6 | ○ | 10 - 11 - 12 - 13 - 14 - 15 mm | | | |
| 1 | | Kardangelen | | | |
| 1 | | Verlängerung 150 mm | | | |
| 1 | | 48 ZAHN, Art. 5210 oder/or
72 ZAHN, Art. 5211 | | | |
| 1 | | 3/8" (Knarre) x 5/16" (Bit) | | | |
| 17 | ○ | 10 - 11 - 12 - 13 - 14 - 15 - 16 - 17 - 18 - 19 - 20 - 21 - 22 - 24 - 27 - 30 - 32 mm | | 1/2" | |
| 5 | ○ | 14 - 15 - 17 - 19 - 22 mm | | | |
| 8 | ⊕ | E10 - E11 - E12 - E14 - E16 - E18 - E20 - E24 | | | |
| 3 | ○ | 16 - 18 - 21 mm | | | |
| 1 | | 3/8" (Knarre) x 1/2" (Nuss) | | | |
| 2 | | Verlängerungen 125 + 250 mm | | | |
| 1 | | Kardangelen | | | |
| 1 | | 48 ZAHN, Art. 5220 oder/or
72 ZAHN, Art. 5221 | | | |
| 1 | | 1/2" (Knarre) x 5/16" (Bit) | | | |
| 7 | | 1,27 - 1,5 - 2 - 2,5 - 3 - 4 - 5 mm | | | |

Größe/Size: 1/4" + 3/8" + 1/2" · tlg./pcs. 182

BxLxH/WxLxH: 400x310x85 mm

Gewicht/Weight: ca. 8.500 g

Art.-Nr./Art.-No.

8663 1/4"+3/8"+1/2" proficraft Steckschlüsselk. 48 Z

8664 1/4"+3/8"+1/2" proficraft Steckschlüsselk. 72 Z

1/2" Werkzeugkoffer, 84-teilig

1/2" Tool Case, 84 pieces

PROJAHN
proficraftArt.-Gruppe 113
Article Group 113**8688**

1/2"

**Werkzeugkoffer
mit 84 Werkzeugen, metrisch****84**
tlg./pcs.

- ▶ **Universell einsetzbare Werkzeugbestückung**
- ▶ **Übersichtlich strukturierte Anordnung der Werkzeuge**
- ▶ **Hochwertiger, dreistufiger Metallkoffer**
- ▶ **Ergonomisches Handling durch schaumummantelte, anklappbare Bügelgriffe**

Tool Case with 84 assorted Tools, metric

- ▶ **Versatile usable Tools**
- ▶ **Clearly structured arrangement of the tools**
- ▶ **High-quality, three-level metal case**
- ▶ **Ergonomic handling by foam-encased, foldable handles**

14 ○ 10 - 12 - 13 - 14 - 15 - 16 - 17 - 19 - 20 -
22 - 24 - 27 - 30 - 32 mm

2 ○ 16 - 21 mm

1 **48 ZAHN**, Art. 5220

2 Verlängerungen 125 + 250 mm



1 Kardangelen



1 3-Wege-Adapter 3/8" x 1/2"

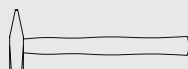

1 Hammer 300 g

8 Ringgabelschlüssel
10 - 11 - 12 - 13 - 14 - 17 - 19 - 22 mm

1 Rollgabelschlüssel 8" / 200 mm



9 1.5 - 2 - 2.5 - 3 - 4 - 5 - 6 - 8 - 10



1 Kombizange 180 mm



1 Seitenschneider 160 mm



1 Telefonzange 170 mm



1 Wasserpumpenzange 250 mm

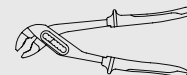

2 PH 1 - PH 2



2 Schlitz 5,5 mm - 6,5 mm

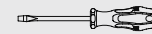

1 Magnetischer Bitschraubendreher

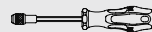

1 Universalschere 180 mm



1 Metallbügelsäge, 300 mm

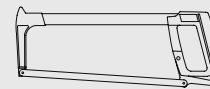

1 Maßband 5 m



1 Wasserwaage 300 mm



5 ⊕ PH 0 - PH 1 - PH 2 - PH 3 - PH 4



5 ⊕ PZ 0 - PZ 1 - PZ 2 - PZ 3 - PZ 4



6 ⊗ TORX® T10 - 15 - 20 - 25 - 27 - 30



7 ⊖ Schlitz: 3 - 4 - 5 - 5,5 - 6 - 6,5 - 7 mm



7 ⊙ Inbus: 1,5 - 2 - 2,5 - 3 - 4 - 5 - 6 mm



1 1 Bit-Halter 60 mm

1/4"

Größe/Size: 1/2" · tlg./pcs. 84**BxLxH/WxLxH:** 490x225x380 mm**Gewicht/Weight:** 13.500 g**Art.-Nr./Art.-No.**

8688 1/2" Werkzeugkoffer mit 84 Werkzeugen

1/4" + 1/2" Universal-Werkzeugkoffer, 149-teilig

1/4" + 1/2" Universal Tool Case, 149 pieces

8681

1/4"

1/2"

149
tlg./pcs.



8681K
Koffer, leer
empty case

12	○	4 - 4,5 - 5 - 5,5 - 6 - 7 - 8 - 9 - 10 - 11 - 12 - 13 mm		9	●	1.5 - 2 - 2.5 - 3 - 4 - 5 - 6 - 8 - 10 mm	
2		Verlängerungen 50 + 100 mm		10		8 - 10 - 11 - 12 - 13 - 14 - 15 - 17 - 19 - 22 mm	
1		48 ZAHN , Art. 5200		1		Telefonzange 160 mm	
1		Gleitgriff 110 mm		1		Kombizange 180 mm	
1		Kardangelenk		1		Wasserpumpenzange 240 mm	
1		1/4" (Knarre) x 1/4" (Bit)		1		Seitenschneider 160 mm	
3	●	4.5 - 5,5 - 6,5 mm		1		Flechtermzange 250 mm	
6	+	2x PH 1 - 2 - 3		2	+	PH 1 - 2	
6	+	2x PZ 1 - 2 - 3		1	+	PZ 2	
9	⊕	TX8 - 9 - 10 - 15 - 20 - 25 - 27 - 30 - 40		3	●	3 - 5,5 - 6,5 mm	
6	●	3 - 4 - 5 - 6 - 7 - 8 mm		1	●	110 bis/up to 250 V Spannungsprüfer	
1		Bit-Halter 60 mm		1		Universalmesser	
1		1/4" x 1/4"		1		Hammer 300 g	
1		Magn. Bit-Schraubendreher		1		Metallsäge 300 mm	
14	○	10 - 13 - 14 - 15 - 16 - 17 - 18 - 19 - 21 - 22 - 24 - 27 - 30 - 32 mm		1		Schieblehre 0 - 150 mm	
2		Verlängerungen 125 + 250 mm		5		Schlag- und Meißelsatz	
1		48 ZAHN , Art. 5220		1		Halbrundfeile	
1		Kardangelenk		1		Spachtel	
1		1/2" x 3/8"		1		Stechbeitel	
1		1/2" (Knarre) x 5/16" (Bit)		1		Zimmermanns-Bleistift	
1		Teleskop Magnetheber		1		Taschenlampe	
1		Maßband 5 m		20		Kabelbinder 3,5 x 150 mm	
				2	●	8 - 10 mm	
				2	+	PH 3 - 4	
				4	⊕	TX40 - 45 - 50 - 55	
				3	●	10 - 12 - 14 mm	

Größe/Size: 1/4" + 1/2" · tlg./pcs. 149

BxLxH/WxLxH: 460x330x145 mm · Gewicht/Weight: 12.240 g

Art.-Nr./Art.-No.

8681 1/4" + 1/2" Werkzeugkoffer

8681-SCHLUESSEL 2 Schlüssel

1/4" + 1/2" Universal-Werkzeugtrolley, 130-teilig

1/4" + 1/2" Universal Tool Trolley, 130 pieces



Art.-Gruppe 113
Article Group 113

4963-01

1/4"

1/2"

130
tlg./pcs.

4963

Trolley, leer
empty trolley



Robuste Rollen/
Robust Castors



Stabile Füße/
Solid Feet



Abschließbare Bügelschlösser/
Lockable U-Locks



Einrastender Teleskopgriff/
Telescopic Snap-Handle



Haltbare Scharniere/
Hard-Wearing Hinges



- 12 ○ 4 - 4,5 - 5 - 5,5 - 6 - 7 - 8 - 9 - 10 - 11 - 12 - 13 mm
- 2 Verlängerungen 100 + 150 mm 1/4"
- 1 **48 ZAHN**, Art. 5200
- 1 Steckgriff
- 1 Kardangelen
- 1 1/4" (Knarre) x 1/4" (Bit)
- 3 ● 4,5 - 5,5 - 6,5 mm
- 6 ⊕ 2x PH 1 - 2 - 3
- 6 ⊕ 2x PZ 1 - 2 - 3
- 9 ⊕ TX8 - 9 - 10 - 15 - 20 - 25 - 27 - 30 - 40
- 6 ● 3 - 4 - 5 - 6 - 7 - 8 mm
- 1 Bit-Halter 60 mm
- 1 Bit-Knarre, Art. 2700
- 1 Magn. Bit-Schraubendreher

- 16 ○ 10 - 11 - 12 - 13 - 14 - 15 - 16 - 17 - 18 - 19 - 21 - 22 - 24 - 27 - 30 - 32 mm 1/2"
- 2 Verlängerungen 125 + 250 mm
- 1 **48 ZAHN**, Art. 5220
- 1 Kardangelen
- 1 Gleitgriff 300 mm

- 1 Teleskop Magnetheber
- 1 Maßband 5 m

- 9 ● 1,5 - 2 - 2,5 - 3 - 4 - 5 - 6 - 8 - 10 mm
- 9 ⊕ TX10 - 15 - 20 - 25 - 27 - 30 - 40 - 45 - 50
- 12 8 - 9 - 10 - 11 - 12 - 13 - 14 - 16 - 17 - 18 - 19 - 22 mm
- 1 Telefonzange 200 mm
- 1 Kombizange 180 mm
- 1 Wasserpumpenzange 250 mm
- 1 Seitenschneider 160 mm
- 1 Flechterzange 250 mm
- 2 ⊕ PH 1 - 2
- 2 ⊕ PZ 1 - 2
- 2 ● 4,0 - 8,0 mm
- 1 ● 110 bis/up to 250 V Spannungsprüfer
- 1 ● VDE/isolated 3,0 mm
- 2 ⊕ VDE/isolated PH1 - 2
- 1 Universalmesser
- 1 Hammer 300 g
- 1 Metallsäge 260 mm
- 1 Schieblehre 0 - 150 mm
- 1 Aluminium-Wasserwaage 400 mm
- 5 Schlag- und Meißelsatz
- 1 Rollgabelschlüssel 10" / 250 mm

Größe/Size: 1/4" + 1/2" · tlg./pcs. 130

BxLxH/WxLxH: 460x390x170 mm · Gewicht/Weight: ca. 17.500 g

Art.-Nr./Art.-No.















4963-01 1/4" + 1/2" Universal-Werkzeugtrolley





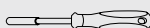
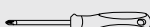
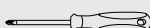
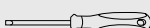

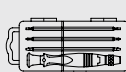





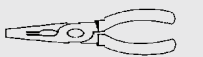

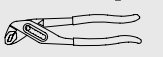
8681-SCHLUESSEL 2 Schlüssel

3/8" Universal-Werkzeugkoffer KOMPAKT, 164-teilig*3/8" Universal Tool Case COMPACT, 164 pieces***PROJAHN**
proficraftArt.-Gruppe 113
Article Group 113**8682**

3/8"

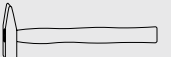
164
tlg./pcs.**8682K**
Koffer, leer
empty case

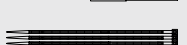
- 17 ○ 6 - 7 - 8 - 9 - 10 - 11 - 12 - 13 - 14 - 15 - 16 - 17 - 18 - 19 - 21 - 22 - 24 mm 
- 1 Verlängerung 150 mm  **3/8"**
- 1 **48 ZAHN**, Art. 5210 
- 1 Kardangelenk 
- 1 3/8" (Knarre) x 1/4" (Bit) 
- 3 ● 4,5 - 5,5 - 6,5 mm  **1/4"**
- 6 ⊕ 2x PH 1 - 2 - 3 
- 6 ⊕ 2x PZ 1 - 2 - 3 
- 9 ⊕ TX8 - 9 - 10 - 15 - 20 - 25 - 27 - 30 - 40 
- 6 ● 3 - 4 - 5 - 6 - 7 - 8 mm 
- 1 Bit-Halter 60 mm 
- 1 Bit-Schraubendreher 
- 2 ⊕ PH 1 - 2 
- 1 ⊕ PZ 2 
- 3 ● 3,5 - 5,5 - 6,0 mm 
- 1 ● 125 bis/up to 230 V Spannungsprüfer 
- 4 Präzisionsschraubendreher-Satz
● 2,0 - 3,0 - 4,0 mm
⊕ PH00 - 0 - 1 
- 1 Teleskop Magnetheber 

- 9 ● 1.5 - 2 - 2.5 - 3 - 4 - 5 - 6 - 8 - 10 mm 
- 10 8 - 10 - 11 - 12 - 13 - 14 - 15 - 17 - 19 - 22 mm 
- 1 Telefonzange 200 mm 
- 1 Kombizange 180 mm 
- 1 Wasserpumpenzange 240 mm 
- 1 Seitenschneider 160 mm 
- 1 Flechterzange 250 mm 
- 1 Universalschere 180 mm 
- 1 Crimpzange 240 mm 
- 40 Kabelschuhe 
- 6 1 Universalmesser + 5 Ersatzklingen (inkl.) 
- 1 Hammer 300 g 
- 1 Metallsäge 260 mm 
- 3 Sägeblätter 
- 20 Kabelbinder 3,5 x 150 mm 
- 1 Wasserwaage 300 mm 
- 1 Maßband 5 m 

Größe/Size: 3/8" · tlg./pcs. 164
BxLxH/WxLxH: 425x280x130 mm
Gewicht/Weight: 9.400 g

Art.-Nr./Art.-No.

8682 3/8" Universal-Werkzeugkoffer

8681-SCHLUESSEL 2 Schlüssel

1/4" Schreiner-Werkzeugkoffer, 92-teilig

1/4" Carpenter Tool Case, 92 pieces



Art.-Gruppe 113
Article Group 113

8684

1/4"

92
tlg./pcs.



8684K
Koffer, leer
empty case

3	● 4,5 - 5,5 - 6,5 mm	1/4"		9	● 1.5 - 2 - 2.5 - 3 - 4 - 5 - 6 - 8 - 10 mm	
6	⊕ 2x PH 1 - 2 - 3			8	8 - 10 - 11 - 12 - 13 - 14 - 17 - 19 mm	
6	⊕ 2x PZ 1 - 2 - 3			5	Holzbohrer 4x75 - 5x85 - 6x90 - 8x110 - 10x120 mm	
9	⊕ TX8 - 9 - 10 - 15 - 20 - 25 - 27 - 30 - 40			1	Beißzange 200 mm	
6	● 3 - 4 - 5 - 6 - 7 - 8 mm			1	Seitenschneider 150 mm	
1	Bit-Halter 60 mm			1	Holzfeile, flach 150 mm	
1	Bit-Schraubendreher			1	Holzfeile, halbrund 150 mm	
2	⊕ PH 1 - 2			3	Hand-Raspel	
4	● 3 - 4 - 5,5 - 6,5 mm			1	Universalschere	
1	● 120 bis/up to 250 V Spannungsprüfer			1	Universalmesser	
3	Zimmermanns-Bleistift			1	Schlosserhammer »Französische Form«	
1	Gliedermaßstab aus Holz, 2 m			1	Kleinhandsägebogen 150 mm	
1	Schmiege 230 mm			1	Handsäge 229 mm	
1	Vorstecher			1	Wasserwaage 400 mm	
1	Hobel 170 mm			5	Schlag- und Meißelsatz	
1	Winkel 90° 300 mm			5	Holz-Stechbeitel 6 - 12 - 16 - 20 - 26 mm	

Größe/Size: 1/4" · tlg./pcs. 92
BxLxH/WxLxH: 460x330x145 mm
Gewicht/Weight: 9.060 g

Art.-Nr./Art.-No.

8684 1/4" Schreiner-Werkzeugkoffer

8681-SCHLUESSEL 2 Schlüssel

1/4" + 1/2" Elektro-Werkzeugkoffer, 128-teilig

1/4" + 1/2" Electrician Tool Case, 128 pieces

8683

1/4"

1/2"

128
tlg./pcs.



8683K
Koffer, leer
empty case

12	○ 4 - 4,5 - 5 - 5,5 - 6 - 7 - 8 - 9 - 10 - 11 - 12 - 13 mm	1/4"		9	● 1.5 - 2 - 2.5 - 3 - 4 - 5 - 6 - 8 - 10 mm	
2	Verlängerungen 50 + 100 mm			9	8 - 10 - 11 - 12 - 13 - 14 - 17 - 19 - 22 mm	
1	48 ZAHN , Art. 5200			1	Telefonzange 150 mm	
1	Gleitgriff 115 mm			1	Kombizange 150 mm	
1	Kardangelenk			1	Seitenschneider 150 mm	
3	● 4,5 - 5,5 - 6,5 mm			1	VDE Abisolierzange 150 mm	
6	⊕ 2x PH 1 - 2 - 3			1	VDE Elektriker-Messer 150 mm	
6	⊕ 2x PZ 1 - 2 - 3			1	Universalschere	
9	⊕ TX8 - 9 - 10 - 15 - 20 - 25 - 27 - 30 - 40			1	Universalmesser	
6	● 3 - 4 - 5 - 6 - 7 - 8 mm			1	Hammer 400 g	
1	Bit-Halter 60 mm			1	Handsägebogen 150 mm	
1	Bit-Schraubendreher			20	Kabelbinder 3,5 x 150 mm	
2	⊕ VDE/isolated PH1 - 2			1	Wasserwaage 400 mm	
4	● VDE/isolated 2,5 - 4 - 5,5 - 6,5 mm			1	Maßband 5 m	
1	● 120 bis/up to 230 V Spannungsprüfer			1	Rollgabelschlüssel 8" / 200 mm	
12	○ 10 - 11 - 12 - 13 - 14 - 15 - 16 - 17 - 18 - 19 - 21 - 22 mm	1/2"		3	Zimmermanns-Bleistift	
1	Verlängerung 125 mm			1	Gliedermaßstab aus Holz, 2 m	
1	48 ZAHN , Art. 5220			1	Spachtel	
1	Kardangelenk			1	Flachmeißel 200 mm	
				1	Spitzmeißel 200 mm	

Größe/Size: 1/4" + 1/2" · tlg./pcs. 128

BxLxH/WxLxH: 460x330x145 mm

Gewicht/Weight: 10.200 g

Art.-Nr./Art.-No.

8683 1/4" + 1/2" Elektro-Werkzeugkoffer

8681-SCHLUESSEL 2 Schlüssel

1/4" + 1/2" Sanitär-Werkzeugkoffer, 95-teilig

1/4" + 1/2" Plumber Tool Case, 95 pieces



Art.-Gruppe 113
Article Group 113

8685

1/4"

1/2"

95
tlg./pcs.



8685K
Koffer, leer
empty case

3	●	4.5 - 5,5 - 6,5 mm	1/4"		10	8x9 - 10x11 - 12x13 - 14x15 - 16x17 - 18x19 - 20x22 - 21x23 - 24x27 - 30x32 mm	
6	+	2x PH1 - 2 - 3			1	Wasserpumpenzange 250 mm	
6	+	2x PZ1 - 2 - 3			1	Eckrohrzange	
9	⊕	TX8 - 9 - 10 - 15 - 20 - 25 - 27 - 30 - 40			1	Hammer 600 g	
6	●	3 - 4 - 5 - 6 - 7 - 8 mm			1	Flachmeißel 200 mm	
1		60 mm Bit-Halter			1	Spitzmeißel 200 mm	
1		Magnetischer Bit- Schraubendreher			1	Handsägebogen 150 mm	
13	○	10 - 11 - 12 - 13 - 14 - 15 - 16 - 17 - 18 - 19 - 21 - 22 - 24 mm	1/2"		1	Feile, halbrund, 150 mm	
1		Verlängerung 125 mm			1	Spachtel	
1		Kardangelen			3	Zimmermanns-Bleistift	
2	+	PH1 - 2			1	Sanitärkreuzschlüssel 200 x 200 mm	
4	●	3 - 4 - 5,5 - 6,5 mm			1	Rohrabschneider 3 - 28 mm	
1	●	120 bis 250 V Spannungsprüfer			1	Rohrabschneider 3 - 42 mm	
1		Gliedermaßstab aus Holz, 2 m			1	Umsteckknarre für 1/2" Vierkant-Antrieb	
1		Wasserwaage 400 mm			1	Vierkant-Adapter 1/2"	
1		Drahtbürste			1	Stufenschlüssel 5-stufig	
9	●	1.5 - 2 - 2.5 - 3 - 4 - 5 - 6 - 8 - 10 mm			1	Standhahn-Mutterschlüssel	
					1	Spezienschlüssel Sanitär	

Größe/Size: 1/4" + 1/2" · tlg./pcs. 95
BxLxH/WxLxH: 460x330x145 mm
Gewicht/Weight: 12.760 g

Art.-Nr./Art.-No.	
8685	1/4" + 1/2" Sanitär-Werkzeugkoffer
8681-SCHLUESSEL	2 Schlüssel

1/4" Werkzeugtasche, 106-teilig

1/4" Tool Bag, 106 pieces

PROJAHN
proficraftArt.-Gruppe 113
Article Group 113**8686****1/4"****394901**
Tasche, leer
Empty bag**Werkzeugtasche mit 106 Werkzeugen, metrisch****106**
tlg./pcs.

- ▶ Umfangreiche, universelle Bestückung
- ▶ 1/4" proficraft-Satz, 45-tlg. (8659)
- ▶ Doppelgabelschlüssel-Set 6-tlg.
- ▶ Ermüdungsarmes Tragen durch ergonomisches Design
- ▶ Zusätzlicher Stauraum vorhanden

Tool Bag with 106 assorted Tools, metric

- ▶ High quality workmanship and materials
- ▶ 1/4" proficraft Set, 45 pcs. (8659)
- ▶ Double open End wrench set, 6 pcs.
- ▶ Easy carrying due to ergonomic design
- ▶ Additional storage space inside

- 3 ● 4,5 - 5,5 - 6,5 mm **1/4"**
- 6 ⊕ 2x PH 1 - PH 2 - PH 3
- 6 ⊕ 2x PZ 1 - PZ 2 - PZ 3
- 9 ⊕ T8 - T9 - T10 - T15 - T20
T25 - T27 - T30 - T40
- 6 ● 3 - 4 - 5 - 6 - 7 - 8 mm
- 1 Bit-Halter 60 mm
- 13 ○ 4 - 4,5 - 5 - 5,5 - 6 - 7 - 8 -
9 - 10 - 11 - 12 - 13 - 14 mm
- 3 ● 4 - 5,5 - 7 mm
- 3 ⊕ PH 1 - PH 2 - PH 3
- 3 ⊕ PZ 1 - PZ 2 - PZ 3
- 6 ● 3 - 4 - 5 - 6 - 7 - 8 mm
- 7 ⊕ T10 - T15 - T20 -
T27 - T30 - T40

- 1 **48 ZAHN**,
Art. 5200
- 1 Steckgriff
- 2 Verlängerungen
50 + 100 mm
- 1 Gleitgriff
- 1 Kardangelen
- 1 Verlängerung
flex. 150 mm
- 1 1/4" x 1/4"
- 3 1,5 - 2 - 2,5 mm
- 6 Doppelgabelschlüssel
6x7 - 8x9 - 10x11 - 12x13 - 14x15 -
16x17 mm in Rolltasche



- 9 ● Sechskant-Kugelpf-Winkelstiftschlüssel
1,5 - 2 - 2,5 - 3 - 4 - 5 - 6 - 8 - 10 mm
- 1 Rollgabelschlüssel 10" / 250 mm
- 1 Telefonzange 150 mm
- 1 Kombizange 175 mm
- 1 Wasserpumpenzange
- 1 Seitenschneider 150 mm
- 2 ⊕ PH1 - PH 2
- 2 ● 5,5 - 6,5 mm
- 1 Hammer 300 g
- 1 Magn. Bitschraubendreher
- 1 Universalmesser
- 1 LED-Taschenlampe
- 1 Gliedermaßstab 2 m

Größe/Size 1/4"
tlg./pcs. 106
BxLxH/WxLxH 340x440x250 mm
Gewicht/Weight 7.200 g

Art.-Nr./Art.-No.

8686 1/4" Werkzeugtasche mit 106 Werkzeugen
 394901 1/4" Werkzeugtasche, unbestückt

Seite / Page
H 194



Ergonomisches Design

Ergonomic Design

- ▶ **Sicherer Halt und ermüdungsfreies Arbeiten durch ergonomisch an die Hand angepasste Griffform**
- ▶ **2-Komponentenmaterial – bruchsicherer, stabiler Kern und griffige Ummantelung mit hoher Rutschhemmung**
- ▶ **Hoher Abgleitschutz durch spezielle Daumenmulden**
- ▶ **Geringere Belastung für Gelenke bei gleichzeitig höherem Drehmoment**
- ▶ **Leichte Einhandbedienung durch Schnelllöseknopf und Richtungsumschalter**
- ▶ *Secure grip and fatigue-free working due to ergonomically to the hand designed ratchet handle*
- ▶ *Two-component material – robust core combined with an ergonomic, slip-resistant surface*
- ▶ *High slip protection due to specially adapted thumb grips*
- ▶ *Less strain on joints combined with a higher torque*
- ▶ *Easy one-handed operation because of quick-release button and direction lever*

INGETRAGENES DESIGN

REGISTERED DESIGN



Profi-Qualität

Professional Quality

- ▶ **Höchstes Qualitätsniveau für anspruchsvolle Anwender**
- ▶ **Präzision und Belastbarkeit weit über DIN-/ISO-Normen**
- ▶ **Hält extremen Drehmomenten bis 650 Nm stand²**
- ▶ **Leichtgängiger, hochpräziser Knarrenmechanismus**
- ▶ **Hohe Öl- und Säurebeständigkeit**
- ▶ *Highest level of quality for demanding users*
- ▶ *Precision and durability far beyond DIN/ISO standards*
- ▶ *Withstands extreme torques up to 650 Nm²*
- ▶ *Smooth-running, high-precision ratchet mechanism*
- ▶ *High oil and acid resistance*

Leistungsstarker Service

Powerful Support

- ▶ **PROJAHN Qualitätsversprechen – 25 Jahre Garantie¹**
- ▶ **Schneller Reparaturservice im Garantiefall**
- ▶ *PROJAHN's promise of quality – 25 years warranty¹*
- ▶ *Fast repair service during warranty time*



¹ Entsprechend unserer allgemeinen Garantiebedingungen / ¹ According to our general warranty conditions

² 1/2" PROJAHN-Umschaltknarre 39012900 / ² PROJAHN ratchet handle 39012900

1/4" + 3/8" + 1/2" Umschaltknarren

1/4" + 3/8" + 1/2" Ratchet Handle

1/4"

3/8"

1/2"

Art.-Gruppe 120
Article Group 120**Xi-on**
MULTISTECKNUSS**Feinzahn-Umschaltknarren mit
2-Komponenten-Griff**
Ratchet with 2K-Handle

Art.-Nr./Art.-No.	Größe/Size
5205	1/4" 72 Z, 70 Nm, 140 mm
5205-1	Reparatur Set für 5205
5215	3/8" 72 Z, 225 Nm, 191 mm
5215-1	Reparatur Set für 5215
5225	1/2" 60 Z, 600 Nm, 260 mm
5225-1	Reparatur Set für 5225

**Feinzahn-Umschaltknarren mit Drehgriff**
Ratchet with Twist Handle

Art.-Nr./Art.-No.	Größe/Size
5204	1/4" 60 Z, 74 Nm, 182 mm
5214	3/8" 60 Z, 242 Nm, 243 mm
5224	1/2" 60 Z, 614 Nm, 292 mm



- ▶ **Das ideale Werkzeuge für enge Arbeitsbereiche**
 - z. B. an Auspuffanlagen, Stellmotoren, Heizungs- und Klimaanlageanlagen sowie am Automatikgetriebe u.v.m.
- ▶ **Extrem leichte Ratschenfunktion durch Drehen des Zwei-Komponenten-Griffes**
- ▶ **Auch zum Einsatz als 'normale' Ratsche mit Feinzahnung (60 Zähne) verwendbar**
- ▶ **Zusätzlich eine robuste 1/4" (6,35 mm)-Vierkantaufnahme zum Aufstecken einer Verlängerung oder eines T-Stücks**
- ▶ **Umschaltung von Rechts- auf Linkslauf durch Durchstecken des Antrieb-Vierkants**
- ▶ *The perfect tool for tight application area*
 - e.g. for exhaust systems, motors, heating and air conditioning systems, automatic gearbox, etc.
- ▶ *Extremely easy ratchet function by turning the two-component handle*
- ▶ *Also usable as a 'usual' ratchet handle with 60 teeth*
- ▶ *Additionally with a sturdy 1/4" (6,35 mm) square drive to plug an extension or a t-handle*
- ▶ *Reversible from right to left drive*

Ideal für enge Stellen
Ideal for tight areas

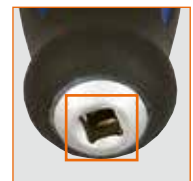

1/2" Umschaltknarren, verlängerbar

1/2" Ratchet Handle, prolongable

1/2"

Art.-Gruppe 120
Article Group 120

1/2" verlängerbare Umschaltknarre mit 3 Griffen

1/2" Extension Ratchet Handle

Art.-Nr./Art.-No. Größe/Size

4298 1/2" Knarre, 600 Nm

4298-1 Reparatur Set für 4298



- ▶ Robuste Umschaltknarre für alle Einsatzbereiche
- ▶ Verlängerbar von 150 auf 290 oder 500 mm
- ▶ Ideale Kraftübertragung durch großen Hebel
- ▶ Umschaltung von Rechts- auf Linkslauf
- ▶ Inkl. Schnelllöseknopf
- ▶ Für hohe Belastungen bis 600 Nm ausgelegt

- ▶ Sturdy ratchet handle for diversity applications
- ▶ Prolongable from 150 to 290 or 500 mm
- ▶ Maximum power transmission through leverage
- ▶ Reversible from right to left drive
- ▶ Incl. quick release button
- ▶ Designed for heavy loads up to 600 Nm



1/2" Teleskop-Umschaltknarre

1/2" Extension Ratchet Handle,

Art.-Nr./Art.-No. Größe/Size

4289 1/2" Knarre, 48 Z

- ▶ Verlängerbar auf 6 Längen:
305, 335, 365, 390, 420, 445 mm
- ▶ Ideale Kraftübertragung durch großen Hebel
- ▶ Umschaltung von Rechts- auf Linkslauf
- ▶ Inkl. Schnelllöseknopf
- ▶ Für hohe Belastungen bis 600 Nm ausgelegt

- ▶ Prolongable to 6 lengths:
305, 335, 365, 390, 420, 445 mm
- ▶ Maximum power transmission through leverage
- ▶ Reversible from right to left drive
- ▶ Incl. quick release button
- ▶ Designed for heavy loads up to 600 Nm



1/4" + 3/8" + 1/2" Umschaltknarren

1/4" + 3/8" + 1/2" Ratchet Handle



Art.-Gruppe 120
Article Group 120

Umschaltknarren mit 2-Komponenten-Griff

Ratchet with 2K-Handle



Art.-Nr./Art.-No.	Größe/Size
5200	1/4" 48 Z, 78 Nm, 140 mm
5200-1	Reparatur Set für 5200
5210	3/8" 48 Z, 245 Nm, 191 mm
5210-1	Reparatur Set für 5210
5220	1/2" 48 Z, 646 Nm, 260 mm
5220-1	Reparatur Set für 5220

Feinzahn-Umschaltknarren mit 2-Komponenten-Griff

Ratchet with 2K-Handle



Art.-Nr./Art.-No.	Größe/Size
5201	1/4" 72 Z, 66 Nm, 140 mm
5201-2	Reparatur Set für 5201 (Version ab 2014)
5201-1	Reparatur Set für 5201 (Version bis 2013)
5211	3/8" 72 Z, 208 Nm, 195 mm
5211-2	Reparatur Set für 5211 (Version ab 2014)
5211-1	Reparatur Set für 5211 (Version bis 2013)
5221	1/2" 72 Z, 549 Nm, 250 mm
5221-2	Reparatur Set für 5221 (Version ab 2014)
5221-1	Reparatur Set für 5221 (Version bis 2013)

Mini-Umschaltknarre

Mini Ratchet Handle



Art.-Nr./Art.-No.	Größe/Size
4299	1/4"/105 mm

Umsteckknarre für 1/2" Vierkant-Antrieb

Ratchet Handle for 1/2" Drive



Art.-Nr./Art.-No.	Größe/Size
4297	1/2" Knarre/ratchet 251 mm
4297-1	1/2" Vierkant
4297-2	Stufenschlüssel, 5-stufig 3/8", 29/64", 31/64", 21/32", 53/64"
4297-3	Stufenschlüssel, 8-stufig 7/8", 27/32", 3/4", 35/64", 1/2", 15/32", 7/16", 3/8", Schraubendreher-Klinge für Schlitzschrauben

Umsteckknarren-Set für 1/2" Vierkant-Antrieb, 3-tlg.

Ratchet Handle Set for 1/2" Drive, 3 pieces

3
tlg./pcs.



Art.-Nr./Art.-No.	Größe/Size
4297-10	1/2" Knarre/ratchet 251 mm + Stufenschlüssel, 5-stufig 3/8", 29/64", 31/64", 21/32", 53/64", 1/2" Vierkant

1/4" + 10 mm Umschaltknarren

1/4" + 10 mm Ratchet Handle



Art.-Gruppe 120
Article Group 120

PROFESSIONAL PLUS STANDARD

10 mm Bit Ratsche umschaltbar
10 mm Bit Ratchet



Art.-Nr./Art.-No.	Größe/Size
4295	10 mm/137 mm

PROFESSIONAL PLUS STANDARD

1/4" Mini Bit Ratsche umschaltbar
1/4" Mini Bit Ratchet



Art.-Nr./Art.-No.	Größe/Size
4294	1/4"/103 mm

PROFESSIONAL PLUS STANDARD

Dual Umschaltknarre für Bits + Nüsse
Dual Ratchet Handle for Bits + Sockets



Art.-Nr./Art.-No.	Größe/Size
4290	1/4" / 105 mm

PROFESSIONAL PLUS STANDARD

1/4" Mini Bit Ratsche umschaltbar
1/4" Mini Bit Ratchet

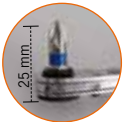

Art.-Nr./Art.-No.	Größe/Size
4288	1/4"/88 mm

PROFESSIONAL PLUS STANDARD

1/4" Mini Bit Ratsche umschaltbar
Bit Ratchet



Art.-Nr./Art.-No.	Größe/Size
2700	1/4"/98 mm

1/4" Steckschlüssel und Antriebselemente

1/4" Sockets and Accessories



Art.-Gruppe 120
Article Group 120

6-kant, Steckschlüssel-Einsätze, metrisch

Sockets, Hex, Metric



Art.-Nr./Art.-No.	Größe/Size	Länge/Length
100035	3,5 mm	25 mm
100040	4,0 mm	25 mm
100045	4,5 mm	25 mm
100050	5,0 mm	25 mm
100055	5,5 mm	25 mm
100060	6,0 mm	25 mm
100070	7,0 mm	25 mm
100080	8,0 mm	25 mm
100090	9,0 mm	25 mm
100100	10,0 mm	25 mm
100110	11,0 mm	25 mm
100120	12,0 mm	25 mm
100130	13,0 mm	25 mm
100140	14,0 mm	25 mm

6-kant, extra tiefe Steckschlüssel-Einsätze, metrisch

Deep Sockets, Hex, Metric



Art.-Nr./Art.-No.	Größe/Size	Länge/Length
101060	6 mm	50 mm
101070	7 mm	50 mm
101080	8 mm	50 mm
101090	9 mm	50 mm
101100	10 mm	50 mm
101110	11 mm	50 mm
101120	12 mm	50 mm
101130	13 mm	50 mm

6-kant, Steckschlüssel-Einsätze, Zoll

Sockets, Hex, Inch



Art.-Nr./Art.-No.	Größe/Size	Länge/Length
100503	3/16"	25 mm
100504	7/32"	25 mm
100505	1/4"	25 mm
100506	9/32"	25 mm
100507	5/16"	25 mm
100508	11/32"	25 mm
100509	3/8"	25 mm
100510	7/16"	25 mm
100511	1/2"	25 mm

6-kant, extra tiefe Steckschlüssel-Einsätze, Zoll

Deep Sockets, Hex, Inch



Art.-Nr./Art.-No.	Größe/Size	Länge/Length
101503	3/16"	50 mm
101504	7/32"	50 mm
101505	1/4"	50 mm
101506	9/32"	50 mm
101507	5/16"	50 mm
101508	11/32"	50 mm
101509	3/8"	50 mm
101510	7/16"	50 mm
101511	1/2"	50 mm

Schlitz-Bit-Schraubereinsätze

Slotted Bit-Sockets



Art.-Nr./Art.-No.	Größe/Size	Länge/Length
102040	4,0 mm	36 mm
102055	5,5 mm	36 mm
102065	6,5 mm	36 mm

Phillips-Bit-Schraubereinsätze

Phillips Bit-Sockets



Art.-Nr./Art.-No.	Größe/Size	Länge/Length
103001	PH 1	36 mm
103002	PH 2	36 mm
103003	PH 3	36 mm

Pozidriv-Bit-Schraubereinsätze

Pozidriv Bit-Sockets



Art.-Nr./Art.-No.	Größe/Size	Länge/Length
104001	PZ 1	36 mm
104002	PZ 2	36 mm
104003	PZ 3	36 mm

TX-Bit-Schraubereinsätze

TX Bit-Sockets



Art.-Nr./Art.-No.	Größe/Size	Länge/Length
105008	T8	36 mm
105009	T9	36 mm
105010	T10	36 mm
105015	T15	36 mm
105020	T20	36 mm
105025	T25	36 mm
105027	T27	36 mm
105030	T30	36 mm
105040	T40	36 mm

Innensechskant-Bit-Schraubereinsätze

Hexagon Bit-Sockets



Art.-Nr./Art.-No.	Größe/Size	Länge/Length
106002	2 mm	36 mm
106003	3 mm	36 mm
106004	4 mm	36 mm
106005	5 mm	36 mm
106006	6 mm	36 mm
106007	7 mm	36 mm
106008	8 mm	36 mm

Steckschlüssel-Einsätze TX

TX Sockets



Art.-Nr./Art.-No.	Größe/Size	Länge/Length
120004	E4 M3	25 mm
120005	E5 M4	25 mm
120006	E6 M5	25 mm
120007	E7 M6	25 mm
120008	E8 M6-7	25 mm
120010	E10 M8	25 mm
120011	E11 -	25 mm

1/4" Steckschlüssel und Antriebselemente

1/4" Sockets and Accessories



Art.-Gruppe 120
Article Group 120

Verlängerungen/Extension Bars

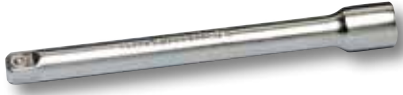

Art.-Nr./Art.-No.	Länge/Length
107050	50 mm
107100	100 mm
107150	150 mm

Verlängerungen mit Verriegelung

Locking Extension Bars



Art.-Nr./Art.-No.	Länge/Length
107052	50 mm
107102	100 mm

Flexible Verlängerung

Flexible Extension Bar



Art.-Nr./Art.-No.	Länge/Length
8605	150 mm

Gleitgriff/Sliding T-Handle



Art.-Nr./Art.-No.	Länge/Length
108100	110 mm
108200	200 mm

Adapter

Adapter



Art.-Nr./Art.-No.	Knarre/Ratchet	Nuss/Socket
4248	1/4"	3/8"
4245	3/8"	1/4"

Kardangeln

Universal Joint



Art.-Nr./Art.-No.	Größe/Size	Länge/Length
110000	Kardangeln	35 mm

Adapter für 1/4" Bits

Adapter for 1/4" Bits



Art.-Nr./Art.-No.	Größe/Size	Länge/Length
2760	1/4"	25 mm

Steckgriff/Spinner Handle



Art.-Nr./Art.-No.	Länge/Length
109150	150 mm

Universal Bit Schraubendreher, magnetisch

Bit Screwdriver, Magnetic



Art.-Nr./Art.-No.	Größe/Size	Länge/Length
2128	1/4"	188 mm

1/4" Stecknuss-Schiene, kurze Nüsse, metrisch

1/4" Socket Rail, Short Sockets, Metric

7 tlg./pcs.



Art.-Nr./Art.-No.	Größe/Size
4201	6 - 8 - 9 - 10 - 11 - 12 - 13 mm
420000	leere Schiene/empty rail

1/4" Stecknuss-Schiene, tiefe Nüsse, metrisch

1/4" Socket Rail, Deep Sockets, Metric

7 tlg./pcs.



Art.-Nr./Art.-No.	Größe/Size
4202	6 - 8 - 9 - 10 - 11 - 12 - 13 mm

420000 leere Schiene/empty rail

1/4" Stecknuss-Schiene Innen-TX Nüsse

1/4" Socket Rail, E-TX Sockets

7 tlg./pcs.



Art.-Nr./Art.-No.	Größe/Size
4203	E4 - E5 - E6 - E7 - E8 - E10 - E11

420000 leere Schiene/empty rail

1/4" Stecknuss-Schiene TX Bit-Nüsse

1/4" Socket Rail, TX Bit Sockets

7 tlg./pcs.



Art.-Nr./Art.-No.	Größe/Size
4204	TX8 - TX10 - TX15 - TX20 - TX25 - TX27 - TX30

420000 leere Schiene/empty rail

1/4" Umschaltknarren

1/4" Ratchet Handle



Art.-Gruppe 120
Article Group 120

PROFESSIONAL PLUS STANDARD

PROJAHN Umschaltknarre mit säurebeständigem Griff, 36 Zähne
Ratchet Handle, 36 teeth



Art.-Nr./Art.-No.	Größe/Size
39014900	1/4" 36 Z, 90 Nm, 147 mm
39014900-1	Reparatur Set für 39014900

PROFESSIONAL PLUS STANDARD



Feinzahn-Umschaltknarre mit 2-Komponenten-Griff, 72 Zähne
Ratchet with 2K-handle, 72 teeth



Art.-Nr./Art.-No.	Größe/Size
5205	1/4" 72 Z, 70 Nm, 140 mm
5205-1	Reparatur Set für 5205

PROFESSIONAL PLUS STANDARD

Umschaltknarre mit 2-Komponenten-Griff, 48 Zähne
Ratchet with 2K-Handle, 48 teeth



Art.-Nr./Art.-No.	Größe/Size
5200	1/4" 48 Z, 78 Nm, 140 mm
5200-1	Reparatur Set für 5200

PROFESSIONAL PLUS STANDARD

U.S. Umschaltknarre, 36 Zähne
Ratchet Handle, U.S. Style, 36 teeth



Art.-Nr./Art.-No.	Größe/Size
4208	1/4" 36 Z, 90 Nm, 147 mm
4200-1	Reparatur Set für 4208

PROFESSIONAL PLUS STANDARD

Feinzahn-Umschaltknarre mit Drehgriff, 60 Zähne
Ratchet with Twist Handle, 60 teeth



Art.-Nr./Art.-No.	Größe/Size
5204	1/4" 60 Z, 74 Nm, 182 mm



Ideal für enge Stellen
Ideal for tight areas

Weitere Informationen auf Seite H 94
Further Information On Page H 94

PROFESSIONAL PLUS STANDARD

Feinzahn-Umschaltknarre mit 2-Komponenten-Griff, 72 Zähne
Ratchet with 2K-Handle, 72 teeth



Verbesserte Ausführung / improved Quality

Art.-Nr./Art.-No.	Größe/Size
5201	1/4" 72 Z, 66 Nm, 140 mm
5201-2	Reparatur Set für 5201 (Version ab 2014)
5201-1	Reparatur Set für 5201 (Version bis 2013, rund)

3/8" Steckschlüssel und Antriebselemente

3/8" Sockets and Accessories



Art.-Gruppe 120
Article Group 120

6-kant, Steckschlüssel-Einsätze, metrisch

Sockets, Hex, Metric



Art.-Nr./Art.-No.	Größe/Size	Länge/Length
200060	6 mm	25,5 mm
200070	7 mm	25,5 mm
200080	8 mm	25,5 mm
200090	9 mm	25,5 mm
200100	10 mm	25,5 mm
200110	11 mm	25,5 mm
200120	12 mm	25,5 mm
200130	13 mm	25,5 mm
200140	14 mm	27,0 mm
200150	15 mm	27,0 mm
200160	16 mm	27,0 mm
200170	17 mm	27,0 mm
200180	18 mm	27,0 mm
200190	19 mm	29,0 mm
200200	20 mm	29,0 mm
200210	21 mm	29,0 mm
200220	22 mm	31,0 mm
200230	23 mm	31,0 mm
200240	24 mm	31,0 mm

6-kant, extra tiefe Steckschlüssel-Einsätze, metrisch

Deep Sockets, Hex, Metric



Art.-Nr./Art.-No.	Größe/Size	Länge/Length
201070	7 mm	64 mm
201080	8 mm	64 mm
201100	10 mm	64 mm
201110	11 mm	64 mm
201120	12 mm	64 mm
201130	13 mm	64 mm
201140	14 mm	64 mm
211214	14 mm	64 mm
12-kant Zündkerzen-Stecknuss		
201150	15 mm	64 mm
201160	16 mm	61 mm
Zündkerzen-Stecknuss		
201170	17 mm	64 mm
201180	18 mm	64 mm
201190	19 mm	64 mm
201210	21 mm	65 mm
Zündkerzen-Stecknuss		
201220	22 mm	64 mm

Schlitz-Bit-Schraubereinsätze

Slotted Bit-Sockets



Art.-Nr./Art.-No.	Größe/Size	Länge/Length
202055	5,5 mm	50 mm
202065	6,5 mm	50 mm
202080	8,0 mm	50 mm
202100	10,0 mm	50 mm

Phillips-Bit-Schraubereinsätze

Phillips Bit-Sockets



Art.-Nr./Art.-No.	Größe/Size	Länge/Length
203001	PH 1	50 mm
203002	PH 2	50 mm
203003	PH 3	50 mm
203004	PH 4	50 mm

6-kant, Steckschlüssel-Einsätze, Zoll

Sockets, Hex, Inch



Art.-Nr./Art.-No.	Größe/Size	Länge/Length
200507	5/16"	25 mm
200509	3/8"	25 mm
200510	7/16"	25 mm
200511	1/2"	25 mm
200512	9/16"	27 mm
200513	5/8"	27 mm
200514	11/16"	27 mm
200515	3/4"	29 mm
200516	13/16"	29 mm
200517	7/8"	31 mm

6-kant, extra tiefe Steckschlüssel-Einsätze, Zoll

Deep Sockets, Hex, Inch



Art.-Nr./Art.-No.	Größe/Size	Länge/Length
201509	3/8"	64 mm
201510	7/16"	64 mm
201511	1/2"	64 mm
201512	9/16"	64 mm
201513	5/8"	61 mm
Zündkerzen-Stecknuss		
201514	11/16"	64 mm
201515	3/4"	64 mm
201516	13/16"	65 mm
Zündkerzen-Stecknuss		
201517	7/8"	64 mm
201518	5/8"	64 mm
201519	13/16"	64 mm

Pozidriv-Bit-Schraubereinsätze

Pozidriv Bit-Sockets



Art.-Nr./Art.-No.	Größe/Size	Länge/Length
204001	PZ 1	50 mm
204002	PZ 2	50 mm
204003	PZ 3	50 mm
204004	PZ 4	50 mm



3/8" Steckschlüssel und Antriebselemente

3/8" Sockets and Accessories



Art.-Gruppe 120
Article Group 120

Innensechskant-Bit-Schraubereinsätze

Hexagon Bit-Sockets



Art.-Nr./Art.-No.	Größe/Size	Länge/Length
206003	3 mm	50 mm
206004	4 mm	50 mm
206005	5 mm	50 mm
206006	6 mm	50 mm
206007	7 mm	50 mm
206008	8 mm	50 mm
206010	10 mm	50 mm

Steckschlüssel-Einsätze TX

TX Sockets



Art.-Nr./Art.-No.	Größe/Size	Länge/Length
220004	E4/M3	31 mm
220005	E5/M4	31 mm
220006	E6/M5	31 mm
220007	E7/M6	31 mm
220008	E8/M6-7	31 mm
220010	E10/M8	31 mm
220011	E11/-	31 mm
220012	E12/M10	31 mm
220014	E14/M12	31 mm
220016	E16/M12	31 mm
220018	E18/M14	31 mm
220020	E20/M16	31 mm

Verlängerungen

Extension Bars



Art.-Nr./Art.-No.	Länge/Length
207075	75 mm
207150	150 mm
207250	250 mm

TX-Bit-Schraubereinsätze

TX Bit-Sockets



Art.-Nr./Art.-No.	Größe/Size	Länge/Length
205010	T10	50 mm
205015	T15	50 mm
205020	T20	50 mm
205025	T25	50 mm
205027	T27	50 mm
205030	T30	50 mm
205040	T40	50 mm
205045	T45	50 mm
205050	T50	50 mm
205055	T55	50 mm

Adapter

Adapter



Art.-Nr./Art.-No.	Knarre/Ratchet	Nuss/Socket
4248	1/4"	3/8"
4245	3/8"	1/4"
4249	3/8"	1/2"
4250	1/2"	3/8"

Sortiment auf Seite / Set on Page
H 118

Kipp Verlängerungen

Wobble Extension Bars

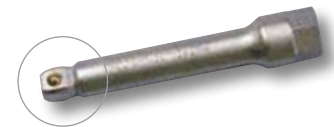

Art.-Nr./Art.-No.	Länge/Length
207076	75 mm
207151	150 mm

Verlängerungen mit Verriegelung

Locking Extension Bars



Art.-Nr./Art.-No.	Länge/Length
207077	75 mm
207152	150 mm

TX-Bit-Schraubereinsätze mit stirnseitiger Bohrung

Tamper TX Bit-Sockets



Art.-Nr./Art.-No.	Größe/Size	Länge/Length
205310	T10	50 mm
205315	T15	50 mm
205320	T20	50 mm
205325	T25	50 mm
205327	T27	50 mm
205330	T30	50 mm
205340	T40	50 mm
205345	T45	50 mm
205350	T50	50 mm
205355	T55	50 mm

Bit-Adapter

Bit Adapter



Art.-Nr./Art.-No.	Größe/Size	Länge/Length
2761	3/8" Adapter f. 1/4" Bits	27 mm

Kardangeln

Universal Joint



Art.-Nr./Art.-No.	Größe/Size	Länge/Length
210000	Kardangeln	51,5 mm

Gleitgriff Adapter

Sliding T-Adapter



Art.-Nr./Art.-No.	Größe/Size
208001	1/2" (Knarre) x 3/8" (Nuss)

3/8" Steckschlüssel und Antriebselemente

3/8" Sockets and Accessories



Art.-Gruppe 120
Article Group 120

PROFESSIONAL PLUS STANDARD

3/8" Durchgangsnüsse, metrisch

3/8" Go-Through Sockets, Metric



Art.-Nr./Art.-No.	Größe/Size
4016-10	10 mm
4016-11	11 mm
4016-12	12 mm
4016-13	13 mm
4016-14	14 mm
4016-15	15 mm
4016-16	16 mm
4016-17	17 mm
4016-19	19 mm

PROFESSIONAL PLUS STANDARD

Durchgangsverlängerung

Go-Through Extension Bar



Art.-Nr./Art.-No.	Länge/Length
4016-02	Durchgangsverlängerung 75 mm

PROFESSIONAL PLUS STANDARD

3/8" Stecknusschiene magnetisch

3/8" Magnetic Socket Rail



Art.-Nr./Art.-No.	Größe/Size
421001	3/8" Stecknusschiene magnetisch/ 3/8" magnetic socket holder inkl. 14 Halter/incl. 14 clips
421011	3/8" Ersatzhalter, 10 Stück/ 3/8" Clips, 10 pieces

PROFESSIONAL PLUS STANDARD

3/8" Stecknuss-Schiene, kurze Nüsse, metrisch

3/8" Socket Rail, Short Sockets, Metric



12
tlg./pcs.

Art.-Nr./Art.-No.	Größe/Size
4211	7 - 8 - 10 - 11 - 12 - 13 - 14 - 15 - 17 - 18 - 19 - 22 mm

421000	leere Schiene/empty rail
--------	--------------------------

PROFESSIONAL PLUS STANDARD

3/8" Stecknuss-Schiene, tiefe Nüsse, metrisch

3/8" Socket Rail, Deep Sockets, Metric



12
tlg./pcs.

Art.-Nr./Art.-No.	Größe/Size
4212	7 - 8 - 10 - 11 - 12 - 13 - 14 - 15 - 17 - 18 - 19 - 22 mm

421000	leere Schiene/empty rail
--------	--------------------------

PROFESSIONAL PLUS STANDARD

Adapter für 1/4" Nüsse

Adapter for 1/4" Sockets



Art.-Nr./Art.-No.	Größe/Size
4016-03	Adapter für 1/4" Nüsse

PROFESSIONAL PLUS STANDARD

3/8" Stecknuss-Schiene, Innen-TX Nüsse

3/8" Socket Rail, E-TX Sockets



12
tlg./pcs.

Art.-Nr./Art.-No.	Größe/Size
4213	E4 - E5 - E6 - E7 - E8 - E10 - E11 - E12 - E14 - E16 - E18 - E20

421000	leere Schiene/empty rail
--------	--------------------------

PROFESSIONAL PLUS STANDARD

3/8" Stecknuss-Schiene, Bit-Nüsse kombiniert

3/8" Socket Rail, Bit Sockets



12
tlg./pcs.

Art.-Nr./Art.-No.	Größe/Size
4214	Posidriv PZ 1 - 2 - 3, Phillips PH 1 - 2 - 3 TX20 - TX27 - TX30 - TX40 - TX45 - TX50 mit Loch

421000	leere Schiene/empty rail
--------	--------------------------



Weitere PROForm-Werkstatteinlagen ab Seite /
More PROForm Inlays for Roller Cabinet from Page H 32

3/8" Umschaltknarren

3/8" Ratchet Handle



Art.-Gruppe 120
Article Group 120

PROFESSIONAL PLUS STANDARD

PROJAHN Umschaltknarre mit säurebeständigem Griff, 38 Zähne

Ratchet Handle, 38 teeth



Art.-Nr./Art.-No.	Größe/Size
39038900	3/8" 38 Z, 280 Nm, 195 mm

39038900-1	Reparatur Set für 39038900
------------	----------------------------

PROFESSIONAL PLUS STANDARD

MULTISTECKNUS
Xi-on

Feinzahn-Umschaltknarre mit 2-Komponenten-Griff, 72 Zähne

Ratchet with 2K-handle, 72 teeth



Art.-Nr./Art.-No.	Größe/Size
5215	3/8" 72 Z, 225 Nm, 191 mm

5215-1	Reparatur Set für 5215
--------	------------------------

PROFESSIONAL PLUS STANDARD

Umschaltknarre mit 2-Komponenten-Griff, 48 Zähne

Ratchet with 2K-Handle, 48 teeth



Art.-Nr./Art.-No.	Größe/Size
5210	3/8" 48 Z, 245 Nm, 191 mm

5210-1	Reparatur Set für 5210
--------	------------------------

PROFESSIONAL PLUS STANDARD

U.S. Umschaltknarre, 38 Zähne

Ratchet Handle, U.S. Style, 38 teeth



Art.-Nr./Art.-No.	Größe/Size
4218	3/8" 38 Z, 280 Nm, 195 mm

4210-1	Reparatur Set für 4218
--------	------------------------

PROFESSIONAL PLUS STANDARD

Feinzahn-Umschaltknarre mit Drehgriff, 60 Zähne

Ratchet with Twist Handle, 60 teeth

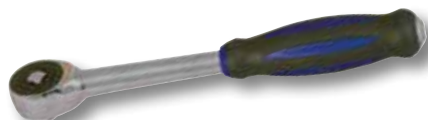

Art.-Nr./Art.-No.	Größe/Size
5214	3/8" 60 Z, 242 Nm, 243 mm

5214-1	Reparatur Set für 5214
--------	------------------------



Ideal für enge Stellen
Ideal for tight areas

Weitere Informationen auf Seite H 94
Further Information On Page H 94

PROFESSIONAL PLUS STANDARD

Feinzahn-Umschaltknarre mit 2-Komponenten-Griff, 72 Zähne

Ratchet with 2K-Handle, 72 teeth



Verbesserte Ausführung /
improved Quality

Art.-Nr./Art.-No.	Größe/Size
5211	3/8" 72 Z, 208 Nm, 195 mm

5211-2	Reparatur Set für 5211 (Version ab 2014)
--------	--

5211-1	Reparatur Set für 5211 (Version bis 2013, rund)
--------	---

1/2" Steckschlüssel und Antriebs Elemente

1/2" Sockets and Accessories



Art.-Gruppe 120
Article Group 120

Verlängerungen

Extension Bars



Art.-Nr./Art.-No.	Länge/Length
307125	125 mm
307250	250 mm

Kipp Verlängerungen

Wobble Extension Bars



Art.-Nr./Art.-No.	Länge/Length
307126	125 mm
307251	250 mm

Verlängerungen mit Verriegelung

Locking Extension Bars



Art.-Nr./Art.-No.	Länge/Length
307127	125 mm
307252	250 mm

Gleitgriff

Sliding T-Handle



Art.-Nr./Art.-No.	Länge/Length
308300	300 mm

Gleitgriff Adapter

Sliding T-Adapter



Art.-Nr./Art.-No.	Größe/Size
308001	T Gleitgriff Adapter 1/2" x 1/2"

Kardangeln

Universal Joint



Art.-Nr./Art.-No.	Größe/Size	Länge/Length
310000	Kardangeln	67 mm

Bit Adapter

Bit Adapter



Art.-Nr./Art.-No.	Größe/Size	Länge/Length
311516	1/2" Adapter f. 5/16" Bits	38 mm

Adapter

Adapter



Art.-Nr./Art.-No.	Knarre/Ratchet	Nuss/Socket
4249	3/8"	1/2"
4250	1/2"	3/8"
4246	1/2"	3/4"
4251	3/4"	1/2"

Sortiment auf Seite / Set on Page
H 118

1/2" Stecknuss-Schiene, kurze Nüsse, metrisch

1/2" Socket Rail, Short Sockets, Metric

10
tlg./pcs.



Art.-Nr./Art.-No.	Größe/Size
4221	10 - 11 - 12 - 13 - 14 - 15 - 17 - 18 - 19 - 22 mm

422000	leere Schiene/empty rail
--------	--------------------------

1/2" Stecknuss-Schiene, tiefe Nüsse, metrisch

1/2" Socket Rail, Deep Sockets, Metric

10
tlg./pcs.



Art.-Nr./Art.-No.	Größe/Size
4222	10 - 11 - 12 - 13 - 14 - 15 - 17 - 18 - 19 - 22 mm

422000	leere Schiene/empty rail
--------	--------------------------

1/2" Stecknuss-Schiene, Innen-TX Nüsse

1/2" Socket Rail, E-TX Sockets

7
tlg./pcs.



Art.-Nr./Art.-No.	Größe/Size
4223	E12 - E14 - E16 - E18 - E20 - E22 - E24

422000	leere Schiene/empty rail
--------	--------------------------

1/2" Steckschlüssel und Antriebselemente

1/2" Sockets and Accessories



Art.-Gruppe 120
Article Group 120

1/2" Stecknuss-Schiene, TX Bit-Nüsse, 60 mm

1/2" Socket Rail, TX Bit Sockets

10
tlg./pcs.



Art.-Nr./Art.-No.	Größe/Size
4236	TX10 - TX15 - TX20 - TX25 - TX27 - TX30 - TX40 - TX45 - TX50 - TX55

422000 leere Schiene/empty rail

1/2" Stecknuss-Schiene, Vielzahn Bit-Nüsse, 60 + 100 mm

1/2" Socket Rail, Spline Bit Sockets

11
tlg./pcs.



Art.-Nr./Art.-No.	Größe/Size
4233	60 mm: M5 - M6 - M8 - M10 - M12 - M14 - M16 100 mm: M5 - M6 - M8 - M10

422000 leere Schiene/empty rail

1/2" Stecknuss-Schiene, Inbus + Vielzahn Bit-Nüsse, 60 mm

1/2" Socket Rail, Hex + Spline Bit Sockets

11
tlg./pcs.



Art.-Nr./Art.-No.	Größe/Size
4235	5 - 6 - 7 - 8 - 10 - 12 mm M5 - M6 - M8 - M10 - M12

422000 leere Schiene/empty rail

1/2" Stecknuss-Schiene, TX Bit-Nüsse, 100 mm

1/2" Socket Rail, TX Bit Sockets

11
tlg./pcs.



Art.-Nr./Art.-No.	Größe/Size
4231	TX10 - TX15 - TX20 - TX25 - TX27 - TX30 - TX40 - TX45 - TX50 - TX55 - TX60

422000 leere Schiene/empty rail

1/2" Stecknuss-Schiene, Inbus Bit-Nüsse, 60 + 100 mm

1/2" Socket Rail, Hex Bit Sockets

11
tlg./pcs.



Art.-Nr./Art.-No.	Größe/Size
4234	60 mm: 5 - 6 - 8 - 10 - 12 mm 100 mm: 5 - 6 - 7 - 8 - 10 - 12 mm

422000 leere Schiene/empty rail

1/2" Stecknuss-Schiene, Inbus + Vielzahn Bit-Nüsse, 100 mm

1/2" Socket Rail, Hex + Spline Bit Sockets

11
tlg./pcs.



Art.-Nr./Art.-No.	Größe/Size
4232	5 - 6 - 7 - 8 - 10 mm M6 - M8 - M10 - M12 - M14 - M16

422000 leere Schiene/empty rail

1/2" Stecknuss-Schiene, TX Bit-Nüsse mit Loch, 60 mm

1/2" Socket Rail, Tamper TX Bit Sockets

10
tlg./pcs.



Art.-Nr./Art.-No.	Größe/Size
4224	TX15 - TX20 - TX25 - TX27 - TX30 - TX40 - TX45 - TX50 - TX55 - TX60

422000 leere Schiene/empty rail

PROFESSIONAL PLUS STANDARD

1/2" Stecknusschiene magnetisch

1/2" Magnetic Socket Rail



Art.-Nr./Art.-No.	Größe/Size
422001	1/2" Stecknusschiene magnetisch/ 1/2" magnetic socket holder inkl. 14 Halter/incl. 14 clips
422011	1/2" Ersatzhalter, 10 Stück/ 1/2" Clips, 10 pieces

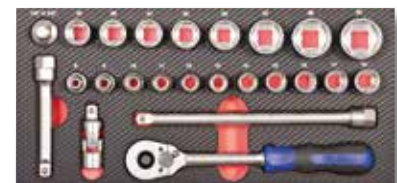

Weitere PROForm-Werkstatteinlagen ab Seite /
More PROForm Inlays for Roller Cabinet from Page H 32

1/2" Umschaltknarren

1/2" Ratchet Handle



Art.-Gruppe 120
Article Group 120

PROFESSIONAL PLUS STANDARD

PROJAHN Umschaltknarre mit säurebeständigem Griff, 40 Zähne
Ratchet Handle, 40 teeth



Art.-Nr./Art.-No.	Größe/Size
39012900	1/2" 40 Z, 640 Nm, 265 mm
39012900-1	Reparatur Set für 39012900

PROFESSIONAL PLUS STANDARD

MULTISTECHNUS Xi-on Feinzahn-Umschaltknarre mit 2-Komponenten-Griff, 60 Zähne
Ratchet with 2K-handle, 60 teeth



Art.-Nr./Art.-No.	Größe/Size
5225	1/2" 60 Z, 600 Nm, 260 mm
5225-1	Reparatur Set für 5225

PROFESSIONAL PLUS STANDARD

Umschaltknarre mit 2-Komponenten-Griff, 48 Zähne
Ratchet with 2K-Handle, 48 teeth



Art.-Nr./Art.-No.	Größe/Size
5220	1/2" 48 Z, 646 Nm, 260 mm
5220-1	Reparatur Set für 5220

PROFESSIONAL PLUS STANDARD

U.S. Umschaltknarre, 40 Zähne
Ratchet Handle, U.S. Style, 40 teeth



Art.-Nr./Art.-No.	Größe/Size
4228	1/2" 40 Z, 640 Nm, 265 mm
4220-1	Reparatur Set für 4228

PROFESSIONAL PLUS STANDARD

Feinzahn-Umschaltknarre mit Drehgriff, 60 Zähne
Ratchet with Twist Handle, 60 teeth

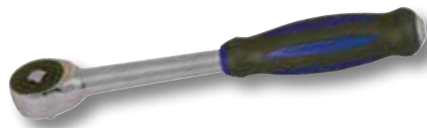

Art.-Nr./Art.-No.	Größe/Size
5224	1/2" 60 Z, 614 Nm, 292 mm



Ideal für enge Stellen
Ideal for tight areas

Weitere Informationen auf Seite H 94
Further Information On Page H 94

PROFESSIONAL PLUS STANDARD

Feinzahn-Umschaltknarre mit 2-Komponenten-Griff, 72 Zähne
Ratchet with 2K-Handle, 72 teeth



Art.-Nr./Art.-No.	Größe/Size
5221	1/2" 72 Z, 549 Nm, 250 mm
5221-2	Reparatur Set für 5221 (Version ab 2014)
5221-1	Reparatur-Set für 5221 (Version bis 2013, rund)

3/4" Steckschlüssel und Antriebselemente

3/4" Sockets and Accessories



Art.-Gruppe 120
Article Group 120

6-kant, Steckschlüssel-Einsätze, metrisch

Sockets, 6-point, Metric



Art.-Nr./Art.-No.	Größe/Size	Länge/Length
400190	19 mm	50,5 mm
400210	21 mm	50,5 mm
400220	22 mm	50,5 mm
400230	23 mm	50,5 mm
400240	24 mm	50,5 mm
400260	26 mm	50,5 mm
400270	27 mm	50,5 mm
400290	29 mm	52,0 mm
400300	30 mm	52,0 mm
400320	32 mm	55,0 mm
400350	35 mm	58,0 mm
400360	36 mm	58,0 mm
400380	38 mm	60,0 mm
400410	41 mm	64,0 mm
400460	46 mm	67,0 mm
400500	50 mm	72,0 mm

Verlängerungen

Extension Bars



Art.-Nr./Art.-No.	Länge/Length
407100	100 mm
407200	200 mm
407400	400 mm

Adapter

Adapter



Art.-Nr./Art.-No.	Knarre/Ratchet	Nuss/Socke
4246	1/2" 49 mm	3/4"
4251	3/4" 53 mm	1/2"
4247	3/4" 62 mm	1"
4252	1" 73 mm	3/4"

Sortiment auf Seite /Set on Page
H 118

3/4" Umschaltknarre

Ratchet Handle



Art.-Nr./Art.-No.	Größe/Size
400001	3/4"
400001-1	Reparatur Set für 400001

T-Gleitgriff

Sliding T-Handle



Art.-Nr./Art.-No.	Länge/Length
408000	450 mm

1" Steckschlüssel und Antriebselemente

1" Sockets and Accessories



Art.-Gruppe 120
Article Group 120

Steckschlüssel-Einsätze, metrisch

Sockets, Metric



Art.-Nr./Art.-No.	Größe/Size	Länge/Length
500360	36 mm	65 mm
500380	38 mm	65 mm
500410	41 mm	70 mm
500460	46 mm	75 mm
500500	50 mm	75 mm
500540	54 mm	79 mm
500550	55 mm	80 mm
500580	58 mm	80 mm
500600	60 mm	84 mm
500630	63 mm	87 mm
500650	65 mm	87 mm
500670	67 mm	89 mm
500700	70 mm	92 mm
500710	71 mm	92 mm
500750	75 mm	96 mm
500770	77 mm	103 mm
500800	80 mm	105 mm

Verlängerungen

Extension Bars



Art.-Nr./Art.-No.	Länge/Length
507200	200 mm
507400	400 mm

Adapter

Adapter



Art.-Nr./Art.-No.	Knarre/Ratchet	Nuss/Socket
4247	3/4" 62 mm	1"
4252	1" 73 mm	3/4"

Gleitgriff Adapter

Sliding T-Adapter



Art.-Nr./Art.-No.	Größe/Size
508000	1" x 1"

1" Umschaltknarre

Ratchet Handle



Art.-Nr./Art.-No.	Größe/Size
500000	1"

Universalgriff

Universal Handle



Art.-Nr./Art.-No.	Länge/Length
508560	560 mm

Kardangeln

Universal Joint



Art.-Nr./Art.-No.	Größe/Size	Länge/Length
510000	Kardangeln	140 mm

Xi-on MULTI-Steckschlüssel

Xi-on MULTI-Sockets

Art.-Gruppe 110
Article Group 110

Xi-on

MULTISTECKNUSS / MULTI SOCKET

Wenn nichts mehr geht, greift Xi-on.

- ▶ **Extrem innovativ:** Revolutionäres Xi-on Spezialprofil öffnet bis zu 85% abgerundete Schrauben und Muttern
- ▶ Greift auch da noch, wo herkömmliche Stecknüsse versagen
- ▶ Öffnet alle gängigen metrischen 6-kant-, 12-kant- und Vielzahn-Muttern & -Schrauben
- ▶ Empfohlen von der Redaktion »Technik und Motor« der FAZ

If Nothing Works, Xi-on Helps.

- ▶ **Extremely innovative:** Revolutionary Xi-on special construction opens up to 85% rounded screws and screw nuts
- ▶ Easy working where even conventional sockets fail
- ▶ Opens all standard metric hex, double hex, spline screw nuts and screws
- ▶ Recommended by »Technik und Motor« of FAZ (established reputed Frankfurt Newspaper, Germany)



Selbst stark beschädigte Schrauben können mit Xi-on geöffnet werden.

Even heavily damaged screws can be opened with Xi-on.

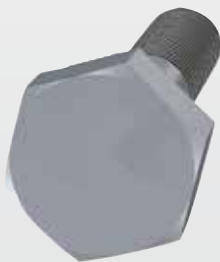

6-kant / Hex



85% abgerundet / rounded



12-kant / Double Hex



Vielzahn / Spline

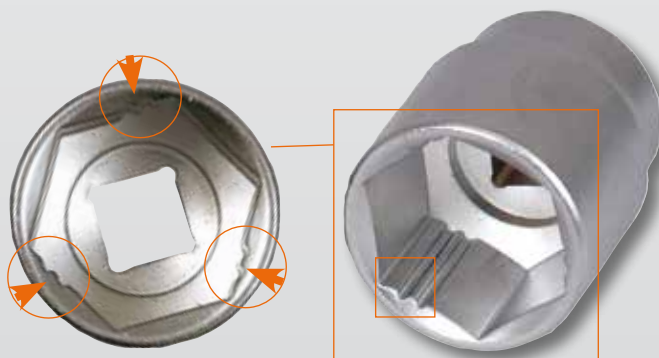

1/4" Xi-on Steckschlüssel und Antriebselemente

1/4" Xi-on Sockets and Accessories

**MULTISTECKNUSS**
Xi-on**Art.-Gruppe 120**
Article Group 120**Xi-on 6-kant Steckschlüssel-Einsätze, metrisch**Xi-on Sockets,
Hex, Metric

Art.-Nr./Art.-No.	Größe/Size	Länge/Length
411004	4,0 mm	25 mm
411045	4,5 mm	25 mm
411005	5,0 mm	25 mm
411055	5,5 mm	25 mm
411006	6,0 mm	25 mm
411007	7,0 mm	25 mm
411008	8,0 mm	25 mm
411009	9,0 mm	25 mm
411010	10,0 mm	25 mm
411011	11,0 mm	25 mm
411012	12,0 mm	25 mm
411013	13,0 mm	25 mm

Xi-on Phillips-Bit Schraubereinsätze, Xi-on Phillips Bit-Sockets

Art.-Nr./Art.-No.	Größe/Size	Länge/Length
411301	PH1	32 mm
411302	PH2	32 mm

Xi-on Innensechskant-Bit-Schraubereinsätze

Hexagon Bit-Sockets



Art.-Nr./Art.-No.	Größe/Size	Länge/Length
411603	3,0 mm	32 mm
411604	4,0 mm	32 mm
411605	5,0 mm	32 mm
411606	6,0 mm	32 mm
411608	8,0 mm	32 mm
411610	10,0 mm	32 mm

1/4" Xi-on Stecknuss-Schiene 6-kant

1/4" Xi-on Socket Rail, Hex

**12**
tlg./pcs.

Art.-Nr./Art.-No.	Größe/Size
4109	Ø 4 - 4,5 - 5 - 5,5 - 6 - 7 - 8 - 9 - 10 - 11 - 12 - 13 mm
423000	leere Schiene/empty rail

Xi-on Kardangelenk

Xi-on Universal Joint



Art.-Nr./Art.-No.	Länge/Length
411100	41 mm

Xi-on Gleitgriff-Adapter

Xi-on Sliding T-Adapter



Art.-Nr./Art.-No.	Beschr./Descr.
411438	3/8" x 1/4" mm

Xi-on Schlitz-Bit Schraubereinsätze,

Xi-on Slotted Bit-Sockets



Art.-Nr./Art.-No.	Größe/Size	Länge/Length
411255	5,5 mm	32 mm
411207	7,0 mm	32 mm

1/4" Stecknusschiene magnetisch

1/4" Magnetic Socket Rail



Art.-Nr./Art.-No.	Größe/Size
420001	1/4" Stecknusschiene magnetisch/ 1/4" magnetic socket holder inkl. 14 Halter/incl. 14 clips
420011	1/4" Ersatzhalter, 10 Stück/ 1/4" Clips, 10 pieces

Xi-on Gleitgriff/Xi-on Sliding T-Handle

Art.-Nr./Art.-No.	Länge/Length
411081	150 mm

Xi-on Steckgriff/Xi-on Spinner Handle

Art.-Nr./Art.-No.	Länge/Length
411915	150 mm

Xi-on Verlängerung/Xi-on Extension Bars

Art.-Nr./Art.-No.	Länge/Length
411705	50 mm
411715	150 mm

MULTISTECKNUSS
Xi-on**Feinzahn-Umschaltknarre mit 2-Komponenten-Griff, 72 Zahn**

Ratchet with 2K-handle, 72 teeth



Art.-Nr./Art.-No.	Größe/Size
5205	1/4" 72 Z, 70 Nm, 140 mm
5205-1	Reparatur Set für 5205

3/8" Xi-on Steckschlüssel und Antriebselemente

3/8" Xi-on Sockets and Accessories



Art.-Gruppe 120
Article Group 120

Xi-on 6-kant Steckschlüssel-Einsätze, metrisch

Xi-on Sockets, Hex, Metric



Art.-Nr./Art.No.	Größe/Size	Länge/Length
412008	8,0 mm	30 mm
412010	10,0 mm	30 mm
412011	11,0 mm	30 mm
412012	12,0 mm	30 mm
412013	13,0 mm	30 mm
412014	14,0 mm	30 mm
412015	15,0 mm	30 mm
412016	16,0 mm	30 mm
412017	17,0 mm	30 mm
412018	18,0 mm	30 mm
412019	19,0 mm	30 mm

3/8" Xi-on Stecknuss-Schiene 6-kant

3/8" Xi-on Socket Rail, Hex



11
tlg./pcs.

Art.-Nr./Art.No.	Größe/Size
4119	Ø 8 - 10 - 11 - 12 - 13 - 14 - 15 16 - 17 - 18 - 19 mm
421000	leere Schiene/empty rail

Xi-on Kardangelenk

Xi-on Universal Joint



Art.-Nr./Art.No.	Länge/Length
412100	57 mm

3/8" Stecknuss-Schiene magnetisch

3/8" Magnetic Socket Rail



Art.-Nr./Art.No.	Größe/Size
421001	3/8" Stecknuss-Schiene magnetisch/ 3/8" magnetic socket holder inkl. 14 Halter/incl. 14 clips
421011	3/8" Ersatzhalter, 10 Stück/ 3/8" clips, 10 pieces

Xi-on Gleitgriff

Xi-on Sliding T-Handle



Art.-Nr./Art.No.	Länge/Length
412920	200 mm

Xi-on Verlängerung

Xi-on Extension Bars

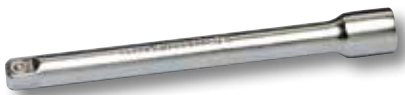

Art.-Nr./Art.No.	Länge/Length
412707	75 mm
412715	150 mm

Sortimente auf Seite /Sets on Page
H 74 - H 75



Weitere PROForm-Werkstatteinlagen ab Seite /
More PROForm Inlays for Roller Cabinet from Page H 36

Xi-on

Feinzahn-Umschaltknarre mit 2-Komponenten-Griff, 72 Zahn

Ratchet with 2K-handle, 72 teeth



Art.-Nr./Art.No.	Größe/Size
5215	3/8" 72 Z, 225 Nm, 191 mm
5215-1	Reparatur Set für 5215

1/2" Xi-on Steckschlüssel und Antriebselemente*1/2" Xi-on Sockets and Accessories***1/2"****MULTISTECKNUSS**
Xi-on**Art.-Gruppe 120**
*Article Group 120***Xi-on 6-kant Steckschlüssel-Einsätze, metrisch***Xi-on Sockets, Hex, Metric,*

Art.-Nr./Art.-No.	Größe/Size	Länge/Length
413010	10,0 mm	38 mm
413011	11,0 mm	38 mm
413012	12,0 mm	38 mm
413013	13,0 mm	38 mm
413014	14,0 mm	38 mm
413015	15,0 mm	38 mm
413016	16,0 mm	38 mm
413017	17,0 mm	38 mm
413018	18,0 mm	38 mm
413019	19,0 mm	38 mm
413021	21,0 mm	38 mm
413022	22,0 mm	38 mm
413024	24,0 mm	38 mm
413027	27,0 mm	45 mm
413030	30,0 mm	45 mm
413032	32,0 mm	45 mm

1/2" Xi-on Stecknuss-Schiene 6-kant*1/2" Xi-on Socket Rail, Hex***10**
tlg./pcs.

Art.-Nr./Art.-No.	Größe/Size
4129	Ø 10 - 11 - 12 - 13 - 14 - 15 - 16 - 17 - 18 - 19 mm
422000	leere Schiene/empty rail

Xi-on Kardangelen*Xi-on Universal Joint*

Art.-Nr./Art.-No.	Länge/Length
413100	73 mm

1/2" Stecknusschiene magnetisch*1/2" Magnetic Socket Rail*

Art.-Nr./Art.-No.	Größe/Size
422001	1/2" Stecknusschiene magnetisch/ 1/2" magnetic socket holder inkl. 14 Halter/incl. 14 clips
422011	1/2" Ersatzhalter, 10 Stück/ 1/2" Clips, 10 pieces

Xi-on Gleitgriff-Adapter*Xi-on Sliding T-Adapter*

Art.-Nr./Art.-No.	Beschr./Descr.
413812	3/8" x 1/2"

Xi-on 6-kant Zündkerzen-Stecknuss, metrisch*Xi-on Spark Plug Sockets, Hex, Metric*

Art.-Nr./Art.-No.	Größe/Size	Länge/Length
413116	16,0 mm	65 mm
413121	21,0 mm	65 mm

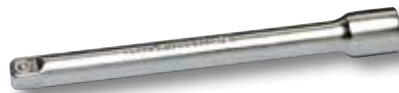
Xi-on Verlängerung*Xi-on Extension Bar*

Art.-Nr./Art.-No.	Länge/Length
413712	125 mm
413725	250 mm

MULTISTECKNUSS
Xi-on**Feinzahn-Umschaltknarre mit 2-Komponenten-Griff, 60 Zahn***Ratchet with 2K-handle, 60 teeth*

Art.-Nr./Art.-No.	Größe/Size
5225	1/2" 60 Z, 600 Nm, 260 mm
5225-1	Reparatur Set für 5225

Weitere PROForm-Werkstatteinlagen ab Seite /
More PROForm Inlays for Roller Cabinet from Page **H 36**Sortimente auf Seite / Sets on Page
H 74 - 75

Drehmomentschlüssel

Torque Wrenches

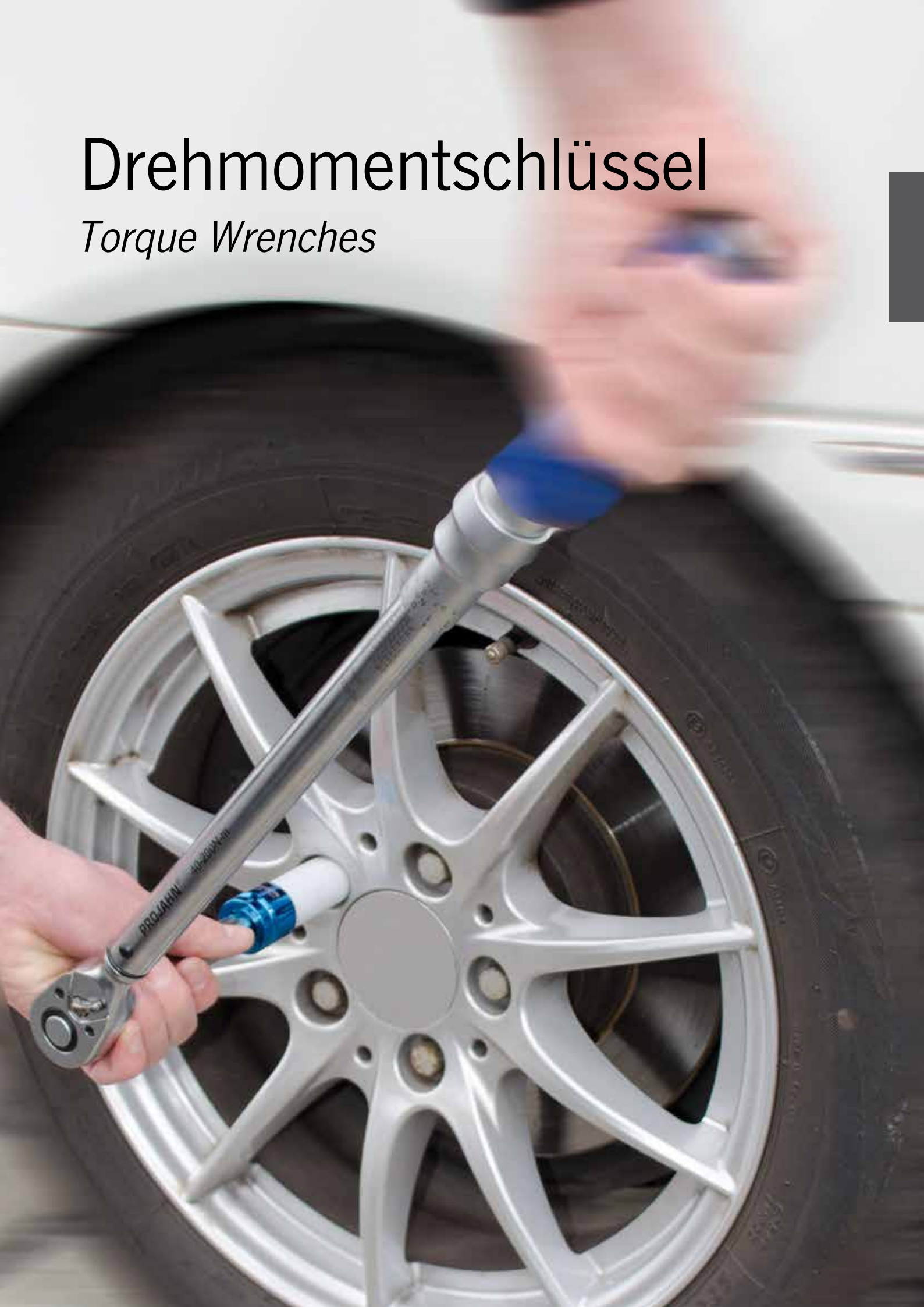

Drehmomentschlüssel TORQUE-PROFI PLUS

Torque Wrenches TORQUE PROFI PLUS

Art.-Gruppe 121
Article Group 121

Auslöserichtung im und gegen den Uhrzeigersinn /
Operative direction clockwise and anti-clockwise

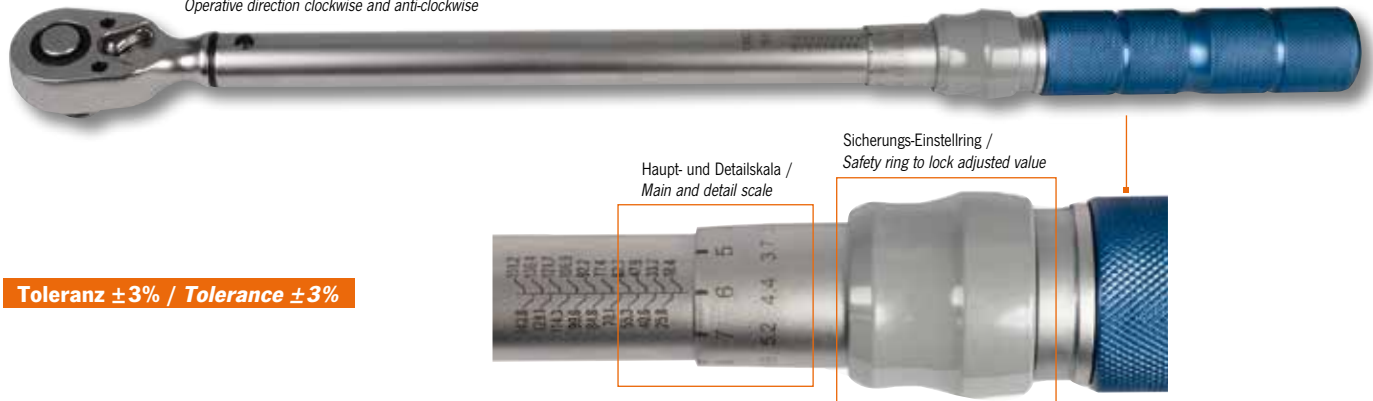

Toleranz $\pm 3\%$ / Tolerance $\pm 3\%$

TORQUE-PROFI PLUS

- ▶ **Mechanischer Zweigweg-Drehmomentschlüssel**
- ▶ **Leichte und sichere Einstellung des Drehmoments**
- ▶ **Sicherungsring zum Sperren der Einstellung**
- ▶ **Hohe Anwendungssicherheit**
 - Hör- und fühlbare automatische Kurzwegauslösung
 - Rutschhemmender, ergonomischer Handgriff
- ▶ **Extrem robust und langlebig**
- ▶ **Technische Daten:**
 - Typ mechanisch, Drehmomentbereich: 5 – 340 Nm
 - Auslöserichtung:
Zweigweg, im und gegen Uhrzeigersinn
 - Mit Schnelllöseknopf und Richtungsumschalter
 - Inklusive Kalibrierungszertifikat nach DIN EN ISO 6789:2003
- ▶ **Achtung:**
 - Drehmomentschlüssel nach Gebrauch auf den kleinsten Wert zurückstellen!
 - Drehmomentschlüssel sollen je nach Gebrauch einmal jährlich neu kalibriert werden. Nutzen Sie hierzu unseren Kalibrierungsservice auf Seite H 118.

TORQUE-PROFI PLUS

- ▶ *Mechanically dual way torque wrench*
- ▶ *Easy and safe adjustment of the torque*
- ▶ *Safety ring to lock the adjustable value*
- ▶ *High application safety*
 - Audible and tactile automatic short path release
 - Ergonomic non-slip handle
- ▶ *Extrem sturdy and durable*
- ▶ **Technically data:**
 - Type mechanically, torque range: 5 – 340 Nm
 - Operative direction:
Dual way, clockwise and anti-clockwise
 - With quick release button and direction lever
 - Incl. certificate of calibration DIN EN ISO 6789:2003
- ▶ **Attention:**
 - After working please turn back to the smallest value of the wrench!
 - Torque wrenches have to be, depending on use, calibrated once a year. Simply use our calibration service on page H 118.

TORQUE-PROFI PLUS

mechanischer Zweigweg-Drehmomentschlüssel

TORQUE-PROFI PLUS

mechanically dual way torque wrench



Toleranz $\pm 3\%$ / Tolerance $\pm 3\%$

Art.-Nr./Art.-No.	Antrieb/Drive	Bereich/Array	Länge/Length
394270	1/4"	5 - 25 Nm	245 mm
394241-1	Reparatur-Set für 394270		
394271	3/8"	20 - 100 Nm	410 mm
394242-1	Reparatur-Set für 394271		
394272	1/2"	40 - 200 Nm	520 mm
394240-1	Reparatur-Set für 394272		
394273	1/2"	60 - 340 Nm	610 mm
394243-1	Reparatur-Set für 394273		

Drehmomentschlüssel TORQUE-PROFI

Torque Wrenches TORQUE PROFI

Art.-Gruppe 121
Article Group 121



Toleranz $\pm 4\%$ / Tolerance $\pm 4\%$

TORQUE-PROFI

- ▶ **Mechanischer Einweg-Drehmomentschlüssel (Uhrzeigersinn)**
- ▶ **Erleichterte Ablesung durch farbig hinterlegte Skala**
- ▶ **Leichtgängiger Einstellring am Griff**
- ▶ **Sicherungsknopf zum Sperren des Einstellrings**
- ▶ **Hohe Anwendungssicherheit**
 - Hör- und fühlbare automatische Kurzwegauslösung
 - Rutschhemmender, ergonomischer Handgriff
- ▶ **Extrem robust und langlebig**
- ▶ **Technische Daten:**
 - Typ mechanisch, Drehmomentbereich: 5 – 340 Nm
 - Auslöserichtung: Einweg, im Uhrzeigersinn
 - Mit Schnelllöseknopf und Richtungsumschalter
 - Inklusive Kalibrierungszertifikat nach DIN EN ISO 6789:2003
- ▶ **Achtung:**
 - Drehmomentschlüssel nach Gebrauch auf den kleinsten Wert zurückstellen!
 - Drehmomentschlüssel sollen je nach Gebrauch einmal jährlich neu kalibriert werden. Nutzen Sie hierzu unseren Kalibrierungsservice auf Seite H 118.

TORQUE-PROFI

- ▶ Mechanically one-way torque wrench (clockwise rotation)
- ▶ Easy readability due to colored measured value display
- ▶ Smooth-running adjustment ring at the handle
- ▶ Safety button to lock the adjustment ring
- ▶ High application safety
 - Audible and tactile automatic short path release
 - Ergonomic non-slip handle
- ▶ Extrem sturdy and durable
- ▶ **Technically data:**
 - Type mechanically, torque range: 5 – 340 Nm
 - Operative direction: One-way, clockwise rotation
 - With quick release button and direction lever
 - Incl. certificate of calibration DIN EN ISO 6789:2003
- ▶ **Attention:**
 - After working please turn back to the smallest value of the wrench!
 - Torque wrenches have to be, depending on use, calibrated once a year. Simply use our calibration service on page H 118.

TORQUE-PROFI

mechanischer Einweg-Drehmomentschlüssel

TORQUE-PROFI

mechanically dual way torque wrench



Toleranz $\pm 4\%$ / Tolerance $\pm 4\%$

Art.-Nr./Art.-No.	Antrieb/Drive	Bereich/Array	Länge/Length
394241	1/4"	5 - 25 Nm	245 mm
394241-1	Reparatur-Set für 394241		
394242	3/8"	20 - 100 Nm	410 mm
394242-1	Reparatur-Set für 394242		
394240	1/2"	40 - 200 Nm	520 mm
394240-1	Reparatur-Set für 394240		
394243	1/2"	60 - 340 Nm	610 mm
394243-1	Reparatur-Set für 394243		

1/2" Drehmomentschlüssel-Set TORQUE-PROFI

1/2" Torque Wrenche Set TORQUE PROFI

1/2"

Art.-Gruppe 121
Article Group 121**394260****1/2" Drehmomentschlüssel-Set, 11-teilig**
Drehmomentschlüssel mit den gebräuchlichsten Nüssen
für den universellen Einsatz

1/2" Torque Wrench Set, 11 pieces with Sockets

Inhalt/Contents:

1/2" Stecknüsse/Sockets 17 - 19 - 21 - 22 - 24 - 27 mm

1/2" Bit-Stecknüsse Innensechskant/Ex Bit Sockets 6 - 8 - 10 - 12 mm

1/2" Drehmomentschlüssel TORQUE-PROFI 40 - 200 Nm

Achtung:

- **Drehmomentschlüssel nach Gebrauch auf den kleinsten Wert zurückstellen!**
- **Drehmomentschlüssel sollen je nach Gebrauch einmal jährlich neu kalibriert werden. Nutzen sie hierzu unseren Kalibrierungsservice auf dieser Seite.**

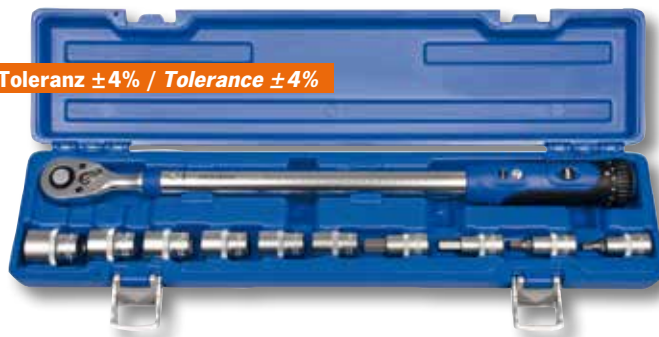
Toleranz $\pm 4\%$ / Tolerance $\pm 4\%$ **Attention:**

- After working please turn back to the smallest value of the wrench!
- Torque wrenches have to be, depending on use, calibrated once a year. Simply use our calibration service on this page.

Art.-Nr./Art.-No.	Antrieb/Drive	Bereich/Array
394260	1/2"	40 - 200 Nm
394240-1	Reparatur-Set für 394260	

Drehmomentschlüssel sollen, je nach Gebrauch, einmal jährlich neu kalibriert werden. Nutzen Sie hierzu unseren Kalibrierungsservice. Wenden Sie sich dazu an unseren Kundenservice unter +49 (0) 60 74 / 69 666 - 66 oder verkauf@projahn.de. Für jede Kalibrierung eines Drehmomentschlüssels berechnen wir 39,90 €.

Torque Wrenches should be, depending on use, calibrated once a year. Simply use our calibration service. Please contact our customer service at +49 (0) 60 74 / 69 666 - 66 or verkauf@projahn.de. For every calibration of a torque wrench we will charge 39,90 €.

Adapter Satz

Adapter Set

6
tlg./pcs.Art.-Gruppe 120
Article Group 120**4259****Adapter Satz, 6-tlg.**

Adapter Set, 6 pieces

**Adapter**

Adapter

Art.-Gruppe 120
Article Group 120

Art.-Nr./Art.-No.	Knarre/Ratchet	Nuss/Socket
4259	Adapter-Satz/Adapter Set	
Inhalt/Content	1/4" 25 mm	3/8"
	3/8" 25 mm	1/4"
	3/8" 33 mm	1/2"
	1/2" 36 mm	3/8"
	1/2" 49 mm	3/4"
	3/4" 53 mm	1/2"

Art.-Nr./Art.-No.	Knarre/Ratchet	Nuss/Socket
4248	1/4" 25 mm	3/8"
4245	3/8" 25 mm	1/4"
4249	3/8" 33 mm	1/2"
4250	1/2" 36 mm	3/8"
4246	1/2" 49 mm	3/4"
4251	3/4" 53 mm	1/2"
4247	3/4" 62 mm	1"
4252	1" 73 mm	3/4"

1/2" Schlag Stecknüsse

1/2" Impact Sockets



Art.-Gruppe 120
Article Group 120

PROJAHN Schlag Stecknüsse sind aus einem speziellen Chrom-Vanadium-Molybdän-Stahl (CMbd) gefertigt. Diese Nüsse sind für den harten Einsatz mit Druckluftschraubern konzipiert.

PROJAHN impact Sockets are produced by a special Chrom-Vanadium-Molybdenum-Steel (CMbd). Due to this these Sockets are for hard use with impact drill machines.

1/2" Schlag Stecknüsse Impact Sockets



Art.-Nr./Art.-No.	Größe/Size	Länge/Length
380008	8 mm	39 mm
380009	9 mm	39 mm
380010	10 mm	39 mm
380011	11 mm	39 mm
380012	12 mm	39 mm
380013	13 mm	39 mm
380014	14 mm	39 mm
380015	15 mm	39 mm
380016	16 mm	39 mm
380017	17 mm	39 mm
380018	18 mm	39 mm
380019	19 mm	39 mm
380020	20 mm	39 mm
380021	21 mm	39 mm
380022	22 mm	39 mm
380023	23 mm	39 mm
380024	24 mm	39 mm
380025	25 mm	39 mm
380027	27 mm	39 mm
380028	28 mm	39 mm
380030	30 mm	48 mm
380032	32 mm	48 mm

1/2" Tiefe Schlag Stecknüsse Deep Impact Sockets



Art.-Nr./Art.-No.	Größe/Size	Länge/Length
381008	8 mm	77 mm
381009	9 mm	77 mm
381010	10 mm	77 mm
381011	11 mm	77 mm
381012	12 mm	77 mm
381013	13 mm	77 mm
381014	14 mm	77 mm
381015	15 mm	77 mm
381016	16 mm	77 mm
381017	17 mm	77 mm
381018	18 mm	77 mm
381019	19 mm	77 mm
381020	20 mm	77 mm
381021	21 mm	77 mm
381022	22 mm	77 mm
381023	23 mm	77 mm
381024	24 mm	77 mm
381025	25 mm	77 mm
381027	27 mm	78 mm
381028	28 mm	78 mm
381030	30 mm	78 mm
381032	32 mm	78 mm

1/2" Tiefe Schlag Stecknüsse für Alu-Felgen

Thin-Wall Deep Impact Sockets



Kunststoffummantelt zum beschädigungsfreien Arbeiten an Alu-Felgen, die farbliche Unterscheidung ermöglicht ein schnelles Auffinden der verschiedenen großen Nüsse.

Thin-wall deep impact Sockets with plastic sleeve for a free of damage work on your aluminium rims. More easier to find the right Size because of different colors.



Art.-Nr./Art.-No.	Größe/Size	Länge/Length
382017	17 mm blau	85 mm
	blue	
382019	19 mm gold	85 mm
	gold	
382021	21 mm rot	85 mm
	red	
382022	22 mm hellgrün	85 mm
	light green	
382024	24 mm dunkelgrün	85 mm
	dark green	



Art.-Nr./Art.-No.	Größe/Size	Länge/Length
382117	17 mm, blau	150 mm
382117-1	Plastiküberzug blau	
382119	19 mm, gold	150 mm
382119-1	Plastiküberzug gold	
382121	21 mm, rot	150 mm
382121-1	Plastiküberzug rot	

Sortimente auf Seite /Sets on Page
H 121



Weitere PROForm-Werkstatteinlagen ab Seite /
More PROForm Inlays for Roller Cabinet from Page H 32

1/2" Schlag Stecknüsse und Zubehör

1/2" Impact Sockets And Accessories



Art.-Gruppe 120
Article Group 120

1/2" E-TX-Schlagnüsse

E-TX Impact Sockets



Art.-Nr./Art.-No.	Größe/Size	Länge/Length
384010	E10	38 mm
384011	E11	38 mm
384012	E12	38 mm
384014	E14	38 mm
384016	E16	38 mm
384018	E18	38 mm
384020	E20	38 mm
384022	E22	45 mm
384024	E24	45 mm

1/2" Inbus Schlagnüsse

Hex Impact Sockets



Art.-Nr./Art.-No.	Größe/Size	Länge/Length
386004	4 mm	78 mm
386005	5 mm	78 mm
386006	6 mm	78 mm
386008	8 mm	78 mm
386010	10 mm	78 mm
386012	12 mm	78 mm
386014	14 mm	78 mm
386017	17 mm	78 mm
386019	19 mm	78 mm

1/2" TX Schlagnüsse

TX Impact Sockets



Art.-Nr./Art.-No.	Größe/Size
385020	TX20
385025	TX25
385027	TX27
385030	TX30
385040	TX40
385045	TX45
385050	TX50
385055	TX55
385060	TX60
385070	TX70



Art.-Nr./Art.-No.	Größe/Size
381000	Kardangeln/Universal Joint



Art.-Nr./Art.-No.	Länge/Length
387075	Verlängerung 75 mm Extension Bar 75 mm

387125	Verlängerung 125 mm Extension Bar 125 mm
--------	---



Art.-Nr./Art.-No.	Größe/Size
381214	1/2" Adapter für 1/4" Bits 1/2" Adapter For 1/4" Bits



Art.-Nr./Art.-No.	Größe/Size
381234	1/2" Adapter für 3/4" Nüsse 1/2" Adapter for 3/4" Sockets

381238	1/2" Adapter für 3/8" Nüsse 1/2" Adapter for 3/8" Sockets
--------	--



Art.-Nr./Art.-No.	Größe/Size
381410	Sicherungs-O-Ring zu Nuss 10-14 mm Ring for 1/2" Sockets 10-14 mm

383216	Sicherungs-O-Ring zu Nuss 16-32 mm Ring for 1/2" Sockets 16-32 mm
--------	--

391410	Sicherungsstift zu Nuss 10-14 mm Pin for 1/2" Sockets 10-14 mm
--------	---

393216	Sicherungsstift zu Nuss 16-32 mm Pin for 1/2" Sockets 16-32 mm
--------	---



Weitere PROForm-Werkstatteinlagen ab Seite /
More PROForm Inlays for Roller Cabinet from Page H 32

1/2" Schlag Stecknuss Sätze

1/2" Impact Socket Sets

1/2"

Art.-Gruppe 120
Article Group 120

1/2" Schlagnuss Satz, 10-teilig

Impact Socket Set

10
tlg./pcs.



Art.-Nr./Art.-No.	Größe/Size
3080	10 - 13 - 14 - 16 - 17 - 18 - 19 - 21 - 22 - 24 mm

1/2" Schlagnuss Satz, 12-teilig

Impact Socket Set

12
tlg./pcs.



Art.-Nr./Art.-No.	Größe/Size
3086	10 - 11 - 13 - 14 - 17 - 19 - 21 - 22 - 23 - 24 mm Verlängerung 125 mm - Kardangelenk

1/2" Tiefer Schlagnuss Satz, 3-teilig

Deep Impact Socket Set

3
tlg./pcs.



Art.-Nr./Art.-No.	Größe/Size
3081	17 - 19 - 21 mm

1/2" Schlagnuss Satz, 3-teilig für Alufelgen

Thin-Wall Deep Impact Socket Set

3
tlg./pcs.



Art.-Nr./Art.-No.	Größe/Size
3082	17 - 19 - 21 mm

1/2" Schlagnuss Satz, 5-teilig für Alufelgen

Thin-Wall Deep Impact Socket Set

5
tlg./pcs.



Art.-Nr./Art.-No.	Größe/Size
3084	17 - 19 - 21 - 22 - 24 mm

1/2" Schlagnuss Satz, 6-teilig Extra tief für Alufelgen

Thin-Wall Extra Deep Impact Socket Set

6
tlg./pcs.



Art.-Nr./Art.-No.	Größe/Size
3083	17 - 19 - 21 mm

1/2" Inbus Schlagnuss Satz, 9-teilig

Hex Impact Socket Set

9
tlg./pcs.



Art.-Nr./Art.-No.	Größe/Size
3861	4 - 5 - 6 - 8 - 10 - 12 - 14 - 17 - 19 mm

1/2" TX Schlagnuss Satz, 9-teilig

TX Impact Socket Set

9
tlg./pcs.



Art.-Nr./Art.-No.	Größe/Size
3851	TX20 - TX25 - TX27 - TX30 - TX40 - TX45 - TX50 - TX55 - TX60

1/2" Xi-on MULTI Schlag Stecknüsse und Zubehör

1/2" Xi-on MULTI Impact Sockets And Accessories



Art.-Gruppe 120
Article Group 120



Wenn nichts mehr geht, greift Xi-on.

- ▶ Extrem innovativ: Revolutionäres Xi-on Spezialprofil öffnet bis zu 85% abgerundete Schrauben und Muttern
- ▶ Greift auch da noch, wo herkömmliche Stecknüsse versagen
- ▶ Öffnet alle gängigen metrischen 6-kant-, 12-kant- und Vielzahn-Muttern & -Schrauben
- ▶ Empfohlen von der Redaktion »Technik und Motor« der FAZ

If Nothing Works, Xi-on Helps.

- ▶ Extremely innovative: Revolutionary Xi-on special construction opens up to 85% rounded screws and screw nuts
- ▶ Easy working where even conventional sockets fail
- ▶ Opens all standard metric hex, double hex, spline screw nuts and screws
- ▶ Recommended by »Technik und Motor« of FAZ (established reputed Frankfurt Newspaper, Germany)



1/2" Schlag Stecknüsse

Impact Sockets

Inklusive passendem Sicherungs-O-Ring und Sicherungsstift

Safety ring and pin inclusive



Art.-Nr./Art.-No.	Größe/Size	Länge/Length
418008	8 mm	39 mm
418010	10 mm	39 mm
418013	13 mm	39 mm
418015	15 mm	39 mm
418016	16 mm	39 mm
418017	17 mm	39 mm
418018	18 mm	39 mm
418019	19 mm	39 mm
418021	21 mm	39 mm
418022	22 mm	39 mm
418024	24 mm	39 mm
418027	27 mm	39 mm
418030	30 mm	48 mm



1/2" Tiefe Schlag Stecknüsse

Deep Impact Sockets

Inklusive passendem Sicherungs-O-Ring und Sicherungsstift

Safety ring and pin inclusive



Art.-Nr./Art.-No.	Größe/Size	Länge/Length
418108	8 mm	77 mm
418110	10 mm	77 mm
418113	13 mm	77 mm
418115	15 mm	77 mm
418117	17 mm	77 mm
418118	18 mm	77 mm
418119	19 mm	77 mm
418121	21 mm	77 mm
418122	22 mm	77 mm
418124	24 mm	77 mm
418130	30 mm	78 mm



1/2" Tiefe Schlag Stecknüsse für Alufelgen

Thin-Wall Deep Impact Sockets



Art.-Nr./Art.-No.	Größe/Size	Länge/Length
418217	17 mm, blau	85 mm
418219	19 mm, gelb	85 mm
418221	21 mm, rot	85 mm

- ▶ Kunststoffummantelung schützt vor Beschädigungen
- ▶ Schnelles Auffinden der passenden Stecknuss durch Farbleitsystem
- ▶ Alle Teile aus Chrom-Vanadium-Molybdän-Stahl (CMbd)
- ▶ Plastic coating reduces damages on aluminium rims
- ▶ Easy to find the right size because of the color coding system
- ▶ All parts produced by a special Chrom-Vanadium-Molybdenum-Steel (Cmbd)



1/2" Schlag Stecknuss Satz für Alufelgen, 3-teilig

Thin-Wall Deep Impact Socket Set, 3 pieces

3
tlg./pcs.



Art.-Nr./Art.-No.	Größe/Size
4182	17 - 19 - 21 mm

3/4" Schlag Stecknüsse und Sätze

3/4" Impact Sockets And Sets



Art.-Gruppe 120
Article Group 120

3/4" Schlag Stecknüsse Impact Sockets



Art.-Nr./Art.-No.	Größe/Size	Länge/Length
480017	17 mm	51 mm
480019	19 mm	51 mm
480020	20 mm	51 mm
480021	21 mm	51 mm
480022	22 mm	51 mm
480023	23 mm	51 mm
480024	24 mm	51 mm
480025	25 mm	51 mm
480026	26 mm	51 mm
480027	27 mm	51 mm
480028	28 mm	54 mm
480029	29 mm	54 mm
480030	30 mm	54 mm
480032	32 mm	56 mm
480033	33 mm	57 mm
480034	34 mm	57 mm
480035	35 mm	57 mm
480036	36 mm	57 mm
480038	38 mm	57 mm
480041	41 mm	57 mm
480046	46 mm	65 mm
480050	50 mm	72 mm

3/4" Tiefe Schlag Stecknüsse Deep Impact Sockets



Art.-Nr./Art.-No.	Größe/Size	Länge/Length
481017	17 mm	89,5 mm
481018	18 mm	89,5 mm
481019	19 mm	89,5 mm
481021	21 mm	89,5 mm
481022	22 mm	89,5 mm
481024	24 mm	89,5 mm
481027	27 mm	89,5 mm
481029	29 mm	89,5 mm
481030	30 mm	89,5 mm
481032	32 mm	89,5 mm
481036	36 mm	89,5 mm
481041	41 mm	89,5 mm
481046	46 mm	89,5 mm
481050	50 mm	89,5 mm



Art.-Nr./Art.-No.	Größe/Size
483410	3/4" Adapter für 1" Nüsse 3/4" Adapter for 1" Sockets
483412	3/4" Adapter für 1/2" Nüsse 3/4" Adapter for 1/2" Sockets



Art.-Nr./Art.-No.	Größe/Size
482619	Sicherungs-O-Ring zu Nuss 19-26 mm Ring for 3/4" Sockets 19-26 mm
4850273x	Sicherungs-O-Ring zu Nuss 27-70 mm 3x Rings for 3/4" Sockets 27-70 mm
492619	Sicherungsstift zu Nuss 19-26 mm Pin for 3/4" Sockets 19-26 mm

3/4" Schlag Stecknüsse Satz, 8-teilig Impact Socket Set, 8 pieces

8
tlg./pcs.



Art.-Nr./Art.-No.	Größe/Size
3085	26 - 27 - 29 - 30 - 32 - 35 - 36 - 38 mm

3/4" Zubehör Accessories



Art.-Nr./Art.-No.	Größe/Size
481000	Kardangeln/Universal Joint



Art.-Nr./Art.-No.	Länge/Length
487100	Verlängerung 100 mm Extension Bar 100 mm
487200	Verlängerung 200 mm Extension Bar 200 mm

1" Schlag Stecknüsse, Satz und Zubehör

1" Impact Sockets And Set and Accessories



Art.-Gruppe 120
Article Group 120

1" Tiefe Schlag Stecknüsse

Deep Impact Sockets



Art.-Nr./Art.-No.	Größe/Size	Länge/Length
580024	24 mm	90 mm
580027	27 mm	90 mm
580030	30 mm	90 mm
580032	32 mm	90 mm
580033	33 mm	90 mm
580034	34 mm	90 mm
580036	36 mm	90 mm
580038	38 mm	90 mm
580041	41 mm	90 mm
580046	46 mm	100 mm
580050	50 mm	100 mm

1" Tiefe Schlag Stecknüsse Satz 8-teilig

Deep Impact Socket Set



8
tlg./pcs.



Art.-Nr./Art.-No.	Größe/Size
3088	24 - 27 - 30 - 32 - 33 - 34 - 36 - 38 mm

1" Zubehör

Accessories



Art.-Nr./Art.-No.	Größe/Size
581000	Kardangelen/Universal Joint



Art.-Nr./Art.-No.	Größe/Size
581034	1" Adapter für 3/4" Nüsse 1" Adapter for 3/4" Sockets



Art.-Nr./Art.-No.	Größe/Size
587019	Sicherungs-O-Ring zu Nuss 19-70 mm Ring for 1" Sockets 19-70 mm

597019	Sicherungsstift zu Nuss 19-70 mm Pin for 1" Sockets 19-70 mm



Art.-Nr./Art.-No.	Länge/Length
587200	Verlängerung 200 mm Extension Bar 200 mm

Schraubenschlüssel

Wrenches



High Tech mit GearTech

High Tech with GearTech

Ergonomisch

Ergonomic

- ▶ **Schlanke Ausführung der Ringseite ermöglicht den Einsatz an engsten Stellen wo herkömmliche Knarren und Steckschlüssel versagen**
 - ▶ **Professioneller Ratschenmechanismus mit 72 Zähnen und 5° Rückholwinkel verbessert zusätzlich das Arbeiten auf engstem Raum**
 - ▶ **Bis 10 mal schnellere Bearbeitung von Schrauben als mit herkömmlichen Schraubenschlüsseln**
 - ▶ **Schnelles Umschalten durch ergonomische Ein-Hand-Bedienung (Ausführung »Umschaltbar«)**
- Slimline version of the ring end side allows working on narrow places where traditional ratchets and sockets fail*
- Professional inside of the ratchet with 72 tooth and 5° returning angle improves working in a limited space additional*
- Open or close screws up to 10 times faster than traditional wrenches*
- Quick reversing due to an ergonomic one-hand function (Version »Reversible«)*



Vielseitig

Versatile

- ▶ **Für jeden Anwender der richtige Problemlöser durch breites Produktsortiment mit 8 verschiedenen Versionen**
 - ▶ **63-in-2 GearTech-Set – Ob metrisch, Inch, Vierkant oder Innen-TX – 63 Funktionen mit 2 GearTech-Schlüssel**
 - ▶ **Noch breitere Anwendungsvielfalt durch erweitertes Produktsortiment bis Größe 50 mm (Ausführung »Klassik«)**
 - ▶ **Große Produktauswahl an perfekt abgestimmten Sets in schützender Rolltasche**
- For every user the right tool due to a wide product range with 8 different versions*
- 63-in-2 GearTech-Set – Whether metric, Inch, square or TX – 63 Functions with 2 GearTech wrenches*
- Larger applying area due to an updated product range (Version »Classic«)*
- Wide product range of perfect customized sets in a protective pouch*

Strapazierfähig und langlebig

Hardwearing and Durable

- ▶ **Langlebiger und dauerhaft belastbarer Ratschenmechanismus – speziell für den professionellen Einsatz aus vergütetem Spezialstahl präzisionsgefertigt**
 - ▶ **Hoch belastbar – Übersteigt die Drehmoment-Normen nach DIN ISO 1711-1**
 - ▶ **Mit widerstandsfähiger »Maul-Seite« zum Lösen extrem fest sitzender Schrauben**
- Durable and long time resistant gear mechanism – produced of a special steel with a high level of precision specially for the professional work*
- Hardwearing – exceeds the DIN ISO 1711-1 standards*
- With a high resistant open end side to loosen extremely tightened screws*

HINWEIS:

Extrem festsitzende Schrauben sind mit der Maul-Seite der GearTech Schlüssel zu lösen. Bei Überlastung droht Bruchgefahr!

Please note:

The GearTech wrenches are designed for fast screwing! In case of opening very hard fixed screws with the gear-side of the wrench, overstraining and breaking of the gear-mechanism is possible.

GearTech Ratschen-Ringgabelschlüssel

GearTech Ratchet Wrench



Art.-Gruppe 122
Article Group 122

GearTech Ratschenschlüssel klassik ohne Umschaltknopf, metrisch, verchromt

GearTech Ratchet Wrench „klassik“



Umschaltung links/rechts erfolgt einfach durch Umdrehen des Schlüssels.

Extrem festsetzende Schrauben sind mit der Maul-Seite der GearTech Schlüssel zu lösen.

Bei Überlastung droht Bruchgefahr!

Switch over is simply made by turning the wrench on the left/on the right.

*The GearTech Wrenches are designed for fast screwing!
In case of opening very hard fixed screws with the gear-side of the wrench, overtightening and breaking of the gear-mechanism is possible.*

Art.-Nr./Art.-No.	Größe/Size	Länge/Length	max Drehm./Max Torque
3406	6 mm	135 mm	27 Nm
3407	7 mm	135 mm	33 Nm
3408	8 mm	140 mm	43 Nm
3409	9 mm	140 mm	57 Nm
3410	10 mm	155 mm	86 Nm
3411	11 mm	170 mm	98 Nm
3412	12 mm	170 mm	112 Nm
3413	13 mm	180 mm	143 Nm
3414	14 mm	185 mm	191 Nm
3415	15 mm	200 mm	250 Nm
3416	16 mm	215 mm	264 Nm
3417	17 mm	230 mm	319 Nm
3418	18 mm	240 mm	359 Nm
3419	19 mm	250 mm	385 Nm
3421	21 mm	280 mm	435 Nm
3422	22 mm	285 mm	506 Nm
3424	24 mm	325 mm	630 Nm
3427	27 mm	360 mm	699 Nm
3430	30 mm	425 mm	837 Nm
3432	32 mm	425 mm	987 Nm
3434	34 mm	482 mm	987 Nm
3436	36 mm	482 mm	987 Nm
3438	38 mm	482 mm	1150 Nm
34411	41 mm	550 mm	1300 Nm
34461	46 mm	640 mm	1500 Nm
34501	50 mm	640 mm	1700 Nm

GearTech Ratschenschlüssel flexibel ohne Umschaltknopf, metrisch, verchromt

GearTech Ratchet Wrench „flexibel“



Umschaltung links/rechts erfolgt einfach durch Umdrehen des Schlüssels.

Extrem festsetzende Schrauben sind mit der Maul-Seite der GearTech Schlüssel zu lösen.

Bei Überlastung droht Bruchgefahr!

Switch over is simply made by turning the wrench on the left/on the right.

*The GearTech Wrenches are designed for fast screwing!
In case of opening very hard fixed screws with the gear-side of the wrench, overtightening and breaking of the gear-mechanism is possible.*

Art.-Nr./Art.-No.	Größe/Size	Länge/Length	max Drehm./Max Torque
3406F	6 mm	135 mm	27 Nm
3407F	7 mm	135 mm	33 Nm
3408F	8 mm	135 mm	43 Nm
3409F	9 mm	143 mm	57 Nm
3410F	10 mm	160 mm	86 Nm
3411F	11 mm	170 mm	98 Nm
3412F	12 mm	173 mm	112 Nm
3413F	13 mm	180 mm	143 Nm
3414F	14 mm	190 mm	191 Nm
3415F	15 mm	200 mm	250 Nm
3416F	16 mm	215 mm	264 Nm
3417F	17 mm	230 mm	319 Nm
3418F	18 mm	235 mm	359 Nm
3419F	19 mm	250 mm	385 Nm
3421F	21 mm	280 mm	435 Nm
3422F	22 mm	285 mm	506 Nm
3424F	24 mm	325 mm	630 Nm
3427F	27 mm	365 mm	699 Nm
3430F	30 mm	430 mm	837 Nm
3432F	32 mm	440 mm	987 Nm



GearTech Ratschen-Doppelringschlüssel

GearTech Ratchet Wrench

Art.-Gruppe 122
Article Group 122

GearTech Doppelringschlüssel klassik ohne Umschaltknopf, verchromt

Double Box GearTech Wrench



Umschaltung links/rechts erfolgt einfach durch Umdrehen des Schlüssels. Bei Überlastung droht Bruchgefahr!

Switch over is simply made by turning the wrench on the left/ on the right. The GearTech Wrenches are designed for fast screwing! In case of opening very hard fixed screws with the gear-side of the wrench, overtorquing and breaking of the gear-mechanism is possible.

Art.-Nr./Art.-No.	Größe/Size	Länge/Length	max Drehm./Max Torque
340810	8 x 10 mm	130 mm	43 Nm/ 86 Nm
341013	10 x 13 mm	170 mm	86 Nm/143 Nm
341213	12 x 13 mm	170 mm	112 Nm/143 Nm
341415	14 x 15 mm	190 mm	191 Nm/250 Nm
341618	16 x 18 mm	230 mm	264 Nm/359 Nm
341719	17 x 19 mm	230 mm	319 Nm/385 Nm



GearTech 4-in-1

umschaltbare Ratschen-Schlüssel

GearTech 4-in-1

Reversible Ratchet Wrenches



Art.-Nr./Art.-No.	Größe/Size	
3463	8x10 - 9x11 - 12x13 - 14x15 - 16x17 - 18x19 mm	Set 3-tlg.
3465	8x10 - 12x13 - 16x17 - 18x19 mm	Set 2-tlg.
390813	8x10 - 12x13 mm	einzeln/single
390915	9x11 - 14x15 mm	einzeln/single
391019	10x13 - 17x19 mm	einzeln/single
391619	16x17 - 18x19 mm	einzeln/single

GearTech Bit-Doppelringschlüssel

*Umschaltbar, ergonomisch gebogen/
reversible, ergonomically curved*



Art.-Nr./Art.-No.	Größe/Size
3914516	1/4" + 5/16"

GearTech Ratschen-Ringgabelschlüssel

GearTech Ratchet Wrench

Art.-Gruppe 122
Article Group 122**3498 / 9981**4
tlg./pcs.**GearTech Ratschenschlüssel Satz, metrisch klassik ohne Umschaltknopf, in Rolltasche**

GearTech Set, „klassik“ in Pouch

5
tlg./pcs.**3498 Inhalt/Contents:** je 1 GearTech Ratschenschl. 10 - 13 - 17 - 19 mm**9981 Inhalt/Contents:** je 1 GearTech Ratschenschl. 8 - 10 - 13 - 17 - 19 mm**Art.-Nr./Art.-No.**

3498	4-tlg./pcs.
9981	5-tlg./pcs.
3499E	Rolltasche leer/empty

**3499****GearTech Ratschenschlüssel Satz, metrisch klassik ohne Umschaltknopf, in Rolltasche**

GearTech Set, „klassik“ in Pouch

8
tlg./pcs.**Inhalt/Contents:**

je 1 GearTech Ratschenschlüssel 8 - 10 - 12 - 13 - 16 - 17 - 18 - 19 mm

Art.-Nr./Art.-No.

3499	8-tlg./pcs.
3499E	Rolltasche leer/empty

**3494****GearTech Ratschenschlüssel Satz, metrisch klassik ohne Umschaltknopf, in Rolltasche**

GearTech Set, „klassik“ in Pouch

14
tlg./pcs.**Inhalt/Contents:** je 1 GearTech Ratschenschlüssel

6 - 7 - 8 - 9 - 10 - 11 - 12 - 13 - 14 - 15 - 16 - 17 - 18 - 19 mm

Art.-Nr./Art.-No.

3494	14-tlg./pcs.
3494E	Rolltasche leer/empty

**3500****GearTech Ratschenschlüssel Satz, metrisch, klassik ohne Umschaltknopf, in Rolltasche**

GearTech Set, „klassik“ in Pouch

20
tlg./pcs.**Inhalt/Contents:** je 1 GearTech Ratschenschlüssel 6 - 7 - 8 - 9 - 10 - 11 -

12 - 13 - 14 - 15 - 16 - 17 - 18 - 19 - 21 - 22 - 24 - 27 - 30 - 32 mm

Art.-Nr./Art.-No.

3500	20-tlg./pcs.
3500E	Rolltasche leer/empty





GearTech Ratschen-Ringgabelschlüssel

GearTech Ratchet Wrench

Art.-Gruppe 122
Article Group 122

3496

**GearTech Ratschenschlüssel Satz,
metrisch, flexibel, in Rolltasche**

4
tlg./pcs.

GearTech Set, „flexible“ in Pouch

Inhalt/Contents: je 1 GearTech Ratschenschlüssel 10 - 13 - 17 - 19 mm

Art.-Nr./Art.-No.

3496	4-tlg./pcs.
3499E	Rolltasche leer/empty



3497

**GearTech Ratschenschlüssel Satz,
metrisch, flexibel, in Rolltasche**

8
tlg./pcs.

GearTech Set, „flexible“ in Pouch

Inhalt/Contents:

je 1 GearTech Ratschenschlüssel 8 - 10 - 12 - 13 - 16 - 17 - 18 - 19 mm

Art.-Nr./Art.-No.

3497	8-tlg./pcs.
3499E	Rolltasche leer/empty



3493

**GearTech Ratschenschlüssel Satz,
metrisch, flexibel, in Rolltasche**

14
tlg./pcs.

GearTech Set, „flexible“ in Pouch

Inhalt/Contents: je 1 GearTech Ratschenschlüssel

6 - 7 - 8 - 9 - 10 - 11 - 12 - 13 - 14 - 15 - 16 - 17 - 18 - 19 mm

Art.-Nr./Art.-No.

3493	14-tlg./pcs.
3494E	Rolltasche leer/empty



3502

**GearTech Ratschenschlüssel Satz,
metrisch, flexibel, in Rolltasche**

20
tlg./pcs.

GearTech Set, „flexible“ in Pouch

Inhalt/Contents: je 1 GearTech Ratschenschlüssel 6 - 7 - 8 - 9 - 10 -

11 - 12 - 13 - 14 - 15 - 16 - 17 - 18 - 19 - 21 - 22 - 24 - 27 - 30 - 32 mm

Art.-Nr./Art.-No.

3502	20-tlg./pcs.
3500E	Rolltasche leer/empty



GearTech Ratschen-Ringgabelschlüssel

GearTech Ratchet Wrench

Art.-Gruppe 122
 Article Group 122
3993**GearTech Ratschenschlüssel Satz, metrisch, umschaltbar, in Rolltasche**

GearTech Set „reversible“ in Pouch

4
 tlg./pcs.

Inhalt/Contents: je 1 GearTech Ratschenschlüssel 10 - 13 - 17 - 19 mm

Art.-Nr./Art.-No.

3993	4-tlg./pcs.
3499E	Rolltasche leer/empty

**3999****GearTech Ratschenschlüssel Satz, metrisch, umschaltbar, in Rolltasche**

GearTech Set „reversible“ in Pouch

8
 tlg./pcs.

Inhalt/Contents:

je 1 GearTech Ratschenschlüssel 8 - 10 - 12 - 13 - 16 - 17 - 18 - 19 mm

Art.-Nr./Art.-No.

3999	8-tlg./pcs.
3499E	Rolltasche leer/empty

**3994****GearTech Ratschenschlüssel Satz, metrisch, umschaltbar, in Rolltasche**

GearTech Set „reversible“ in Pouch

14
 tlg./pcs.

Inhalt/Contents: je 1 GearTech Ratschenschlüssel

6 - 7 - 8 - 9 - 10 - 11 - 12 - 13 - 14 - 15 - 16 - 17 - 18 - 19 mm

Art.-Nr./Art.-No.

3994	14-tlg./pcs.
3494E	Rolltasche leer/empty

**3501****GearTech Ratschenschlüssel Satz, metrisch, umschaltbar, in Rolltasche**

GearTech Set „reversible“ in Pouch

20
 tlg./pcs.

Inhalt/Contents: je 1 GearTech Ratschenschlüssel 6 - 7 - 8 - 9 - 10 - 11 -

12 - 13 - 14 - 15 - 16 - 17 - 18 - 19 - 21 - 22 - 24 - 27 - 30 - 32 mm

Art.-Nr./Art.-No.

3501	20-tlg./pcs.
3500E	Rolltasche leer/empty





GearTech Ratschenschlüssel

GearTech Ratchet Wrenches

Art.-Gruppe 122
Article Group 122

3466

2
tlg./pcs.

GearTech 63-in-2 (Set 2-teilig)
umschaltbare Ratschen-Schlüssel in Rolltasche

GearTech 63-in-2 Reversible Ratchet Wrench in Pouch



Anwendungsübersicht / Application Overview

Größe/Size		Größe/Size		Größe/Size		Größe/Size		Größe/Size	
6-kant/ Hex		12-kant/ Double hex		4-kant/ Square		Vielzahn/ Spline		TORX®E	
mm	inch	mm	inch	mm	inch	mm			
8	5/16	8	5/16	7	9/32	8			E10
10	3/8	10	3/8		11/32	10			E12
11	7/16	11	7/16	9	3/8	11			E14
13	1/2	13	1/2	11	7/16	13			E16
14	9/16	14	9/16	12	15/32	14			E18
16	5/8	16	5/8	13	17/32	16			E20
17	11/16	17	11/16	14	9/16	17			E22
19	3/4	19	3/4	16	5/8	19			E24

- ▶ **Umschaltbarer GearTech Ratschenschlüssel mit Multifunktions-Ratscheneinsatz**
- ▶ **Jeder Schlüssel funktioniert an mehr als 30 verschiedenen Schraubenantrieben**
- ▶ **4-kant, 6-kant, 12-kant, Vielzahn und TORX®E mit einem Schlüssel bearbeiten**
- ▶ **Passend für metrische und zöllige Schraubenantriebe**
- ▶ *Reversible GearTech ratchet wrench with multifunctional ratchet insert*
- ▶ *Every wrench works on more than 30 different fasteners*
- ▶ *Square, hex, double hex, Spline, TORX®E handling with one wrench*
- ▶ *Fits for metric and inch fasteners*

Art.-Nr./Art.-No. Größe/Size

3466 8 - 10 - 11 - 13 - 14 - 16 - 17 - 19 mm,
5/16" - 3/8" - 7/16" - 1/2" - 9/16" - 5/8" - 11/16" - 3/4"
E10 - E12 - E14 - E16 - E18 - E20 - E22 - E24

3466-01

GearTech 31-in-1
umschaltbarer Ratschen-Schlüssel

GearTech 31-in-1 Reversible Ratchet Wrench



Anwendungsübersicht / Application Overview

Größe/Size		Größe/Size		Größe/Size		Größe/Size		Größe/Size	
6-kant/ Hex		12-kant/ Double hex		4-kant/ Square		Vielzahn/ Spline		TORX®E	
mm	inch	mm	inch	mm	inch	mm			
8	5/16	8	5/16	7	9/32	8			E10
10	3/8	10	3/8		11/32	10			E12
11	7/16	11	7/16	9	3/8	11			E14
13	1/2	13	1/2	11	7/16	13			E16

Art.-Nr./Art.-No. Größe/Size

3466-01 8 - 10 - 11 - 13 mm
5/16" - 7/16" - 3/8" - 1/2"
E10 - E12 - E14 - E16

3466-02

GearTech 32-in-1
umschaltbarer Ratschen-Schlüssel

GearTech 32-in-1 Reversible Ratchet Wrench



Anwendungsübersicht / Application Overview

Größe/Size		Größe/Size		Größe/Size		Größe/Size		Größe/Size	
6-kant/ Hex		12-kant/ Double hex		4-kant/ Square		Vielzahn/ Spline		TORX®E	
mm	inch	mm	inch	mm	inch	mm			
14	9/16	14	9/16	12	15/32	14			E18
16	5/8	16	5/8	13	17/32	16			E20
17	11/16	17	11/16	14	9/16	17			E22
19	3/4	19	3/4	16	5/8	19			E24

Art.-Nr./Art.-No. Größe/Size

3466-02 14 - 16 - 17 - 19 mm
9/16" - 11/16" - 5/8" - 3/4"
E18 - E20 - E22 - E24

GearTech Ratschenschlüssel

GearTech Ratchet Wrenches



Art.-Gruppe 122
Article Group 122

3465

GearTech 4-in-1 (Set 2-teilig) umschaltbare Ratschen-Schlüssel in Rolltasche

GearTech 4-in-1 (2 pieces)
Reversible Ratchet Wrenches
in Pouch



2
tlg./pcs.

3463

GearTech 4-in-1 (Set 3-teilig) umschaltbare Ratschen-Schlüssel in Rolltasche

GearTech 4-in-1 (3 pieces)
Reversible Ratchet Wrenches
in Pouch



3
tlg./pcs.

Nur 1 umschaltbarer GearTech Schlüssel um 4 Größen zu schrauben!
Jede Seite des doppelseitigen Schlüssels beinhaltet 2 Größen =
4 Größen pro Schlüssel. Jede Größe ist umschaltbar von links nach rechts.

*Only one reversible GearTech ratchet wrench for 4 sizes!
Every side of the double-sided wrench includes 2 sizes =
4 sizes per wrench. Every size is reversible from left to right.*

Nur 1 umschaltbarer GearTech Schlüssel um 4 Größen zu schrauben!
Jede Seite des doppelseitigen Schlüssels beinhaltet 2 Größen =
4 Größen pro Schlüssel. Jede Größe ist umschaltbar von links nach rechts.

*Only one reversible GearTech ratchet wrench for 4 sizes!
Every side of the double-sided wrench includes 2 sizes =
4 sizes per wrench. Every size is reversible from left to right.*

Art.-Nr./Art.-No. Größe/Size

3465 8x10 - 12x13 - 16x17 - 18x19 mm Set 2-tlg.

Art.-Nr./Art.-No. Größe/Size

3463 8x10 - 9x11 - 12x13 - 14x15 - 16x17 - 18x19 mm Set 3-tlg.

Spezial Stecknuss Adapter für GearTech Schlüssel

Socket and Bit Adapter for GearTech Wrenches

4
tlg./pcs.



Art.-Nr./Art.-No.

Größe/Size

3690 Satz 4-tlg./Set 4 pieces

1/4" - 3/8" - 1/2" - 1/4" Bit

Lange Ringgabelschlüssel

Combination Wrenches XL

Art.-Gruppe 123
Article Group 123

Lange Ringgabelschlüssel metrisch, nach DIN 3113 Form A

Combination Wrenches, Metric, XL

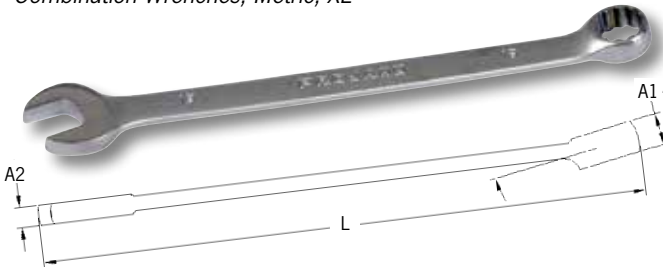

- ▶ Größere Auflagefläche, höhere Lebensdauer
 - ▶ Anziehen mit der Schraubenfläche und nicht über die Schraubenkante
 - ▶ Maulstellung 15°, Ringseite 15° abgewinkelt
 - ▶ Vernickelt und verchromt matt satiniertes Oberflächenfinish
 - ▶ Lange Ausführung
- ▶ Larger contact surface, higher service life
 - ▶ Tightening by the screw surface, not by the edges of the screw
 - ▶ Jaw position 15°, ring end 15° angled
 - ▶ Nickel- and chromium-plated in satin mat finish
 - ▶ Long pattern

Art.-Nr./Art.-No.	L x A2 x A1	Größe/Size
25081	148 x 4,1 x 5,5 mm	8 mm
25091	167 x 4,1 x 6,0 mm	9 mm
25101	172 x 4,6 x 6,5 mm	10 mm
25111	186 x 4,7 x 6,5 mm	11 mm
25121	197 x 4,8 x 7,0 mm	12 mm
25131	207 x 5,5 x 7,5 mm	13 mm
25141	223 x 5,6 x 8,0 mm	14 mm
25151	233 x 5,7 x 8,5 mm	15 mm
25161	243 x 5,8 x 9,0 mm	16 mm
25171	261 x 6,3 x 9,5 mm	17 mm
25181	270 x 6,8 x 10,0 mm	18 mm
25191	280 x 7,1 x 10,4 mm	19 mm
25201	290 x 7,2 x 10,9 mm	20 mm
25211	301 x 7,5 x 11,4 mm	21 mm
25221	318 x 8,0 x 11,9 mm	22 mm
25241	338 x 8,2 x 12,9 mm	24 mm
25271	376 x 8,9 x 14,4 mm	27 mm
25301	394 x 10,0 x 15,9 mm	30 mm
25321	435 x 10,8 x 16,9 mm	32 mm

Ringgabelschlüssel, Zoll

Combination Wrenches, Inch

Art.-Gruppe 123
Article Group 123

Ringgabelschlüssel, Zoll, hochglanzpoliert

Combination Wrenches, Inch

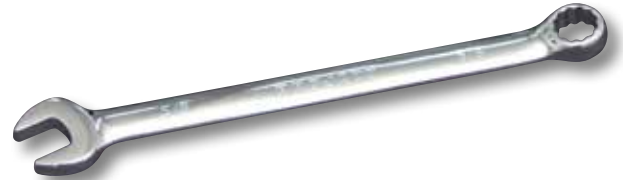

- ▶ Größere Auflagefläche, höhere Lebensdauer
 - ▶ Anziehen mit der Schraubenfläche und nicht über die Schraubenkante
 - ▶ Maulstellung 15°, Ringseite 15° abgewinkelt
 - ▶ Hochglanzpoliert
- ▶ Larger contact surface, higher service life
 - ▶ Tightening by the screw surface, not by the edges of the screw
 - ▶ Jaw position 15°, ring end 15° angled
 - ▶ Mirror polished

Art.-Nr./Art.-No.	Größe/Size	Länge/Length
2561	1/4"	130 mm
2562	5/16"	145 mm
2563	3/8"	165 mm
2564	7/16"	185 mm
2565	1/2"	205 mm
2566	9/16"	220 mm
2567	5/8"	240 mm
2568	11/16"	260 mm
2569	3/4"	280 mm
2570	7/8"	315 mm
2571	15/16"	335 mm
2572	1"	355 mm

DOLPHIN Ringgabelschlüssel*

DOLPHIN Combination Wrenches*

Art.-Gruppe 123
Article Group 123

DOLPHIN Ringgabelschlüssel, metrisch

DOLPHIN Combination Wrenches, Metric



- ▶ **Breiterer Anwendungsbereich**
- ▶ **25% höhere Kraftübertragung**
- ▶ **Hochwertige Verarbeitung und Materialien**
 - Robuste, langlebige Qualität
 - Übertrifft DIN-/ANSI-Normen
- ▶ **Innovative Ringgeometrie ermöglicht das Verschrauben in Vertiefungen**
- ▶ **Spezielle Winkelgeometrie maximiert die Kontaktfläche**

- ▶ *Wider scope as standard combination wrenches*
- ▶ *25% higher power transmission*
- ▶ *High-quality manufacture and materials*
 - *Sturdy, durable quality*
 - *Exceeds DIN-/ANSI-Standard*
- ▶ *Innovative ring geometry allows screwing in grooves*
- ▶ *Special angle geometry maximizes the contact area*

Art.-Nr./Art.-No.	Größe/Size	Länge/Length
25065*	6 mm	140 mm
25075*	7 mm	145 mm
25085*	8 mm	153 mm
25095*	9 mm	162 mm
25105*	10 mm	150 mm
25115*	11 mm	175 mm
25125*	12 mm	185 mm
25135*	13 mm	175 mm
25145*	14 mm	185 mm
25155*	15 mm	215 mm
25165*	16 mm	200 mm
25175*	17 mm	235 mm
25195*	19 mm	235 mm
25225*	22 mm	290 mm
25245*	24 mm	300 mm
25275*	27 mm	350 mm
25305*	30 mm	405 mm
25325*	32 mm	410 mm

*Lieferung nur solange der Vorrat reicht / *Delivery while stocks last

CLICKTECH Ratschen-Ringgabelschlüssel

CLICKTECH Ratchet Combination Wrenches

Art.-Gruppe 123
Article Group 123

CLICKTECH Ratschen-Ringgabelschlüssel, metrisch

CLICKTECH Ratchet Combination Wrenches, Metric

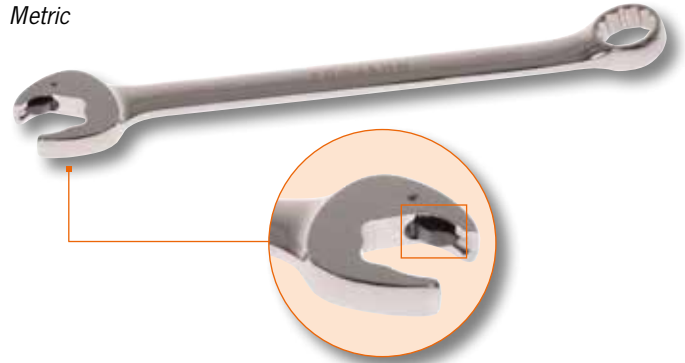

- ▶ **Ringgabelschlüssel mit Ratschenfunktion auf der Gabelseite**
 - Ermöglicht Arbeiten bei extrem engem Arbeitsbereich
 - Verschraubung ohne wiederholtes Neu-Ansetzen des Schraubenschlüssels
- ▶ **Hochwertige Verarbeitung und Materialien**
 - Robuste, langlebige Qualität
- ▶ **Lösen extrem festsitzender Verbindungen durch Ringseite möglich**

- ▶ *Combination wrench with ratchet function at the open end*
 - *Allows working on extremely narrow places*
 - *Screwing without repeated placing of the wrench*
- ▶ *High quality workmanship and materials*
 - *Sturdy, durable quality*
- ▶ *Loosen extremely tightened screws with ring end*

Art.-Nr./Art.-No.	Größe/Size	Länge/Length
25008	8 mm	136 mm
250010	10 mm	161 mm
250012	12 mm	174 mm
250013	13 mm	180 mm
250016	16 mm	207 mm
250017	17 mm	227 mm
250018	18 mm	239 mm
250019	19 mm	250 mm

Sortimente auf Seite/Sets on Page
H 147

Doppelgabelschlüssel

Double Open End Wrenches

Art.-Gruppe 123
Article Group 123

Doppelgabelschlüssel metrisch, nach DIN 3110

Double Open End Wrenches, Metric

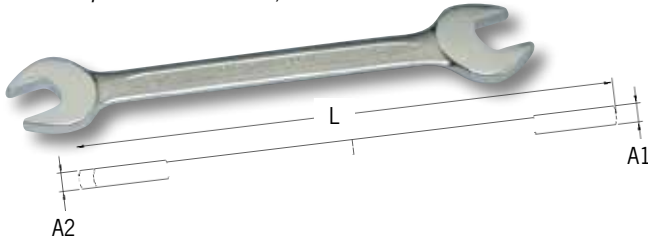

- ▶ Gabelstellung 15°
- ▶ Vernickelt + verchromt matt satiniertes Oberflächenfinish
- ▶ Open end position 15°
- ▶ Nickel- and chromium-plated in satin mat finish

Art.-Nr./Art.-No.	L x A2/A1	Größe/Size
250607	122 x 3,3 mm	6 x 7 mm
250809	140 x 3,6 mm	8 x 9 mm
251008	140 x 3,6 mm	8 x 10 mm
251011	156 x 4,6 mm	10 x 11 mm
251013	172 x 5,1 mm	10 x 13 mm
251213	172 x 5,1 mm	12 x 13 mm
251317	188 x 5,6 mm	13 x 17 mm
251415	188 x 5,6 mm	14 x 15 mm
251617	204 x 6,1 mm	16 x 17 mm
251719	220 x 6,5 mm	17 x 19 mm
251819	220 x 6,5 mm	18 x 19 mm
251922	234 x 7,2 mm	19 x 22 mm
252022	234 x 7,2 mm	20 x 22 mm
252123	247 x 7,5 mm	21 x 23 mm
252224	247 x 7,5 mm	22 x 24 mm
252426	266 x 8,2 mm	24 x 26 mm
252427	266 x 8,2 mm	24 x 27 mm
252430	285 x 8,2 mm	24 x 30 mm
252528	285 x 8,4 mm	25 x 28 mm
252730	302 x 9,1 mm	27 x 30 mm
252732	302 x 9,1 mm	27 x 32 mm
253032	302 x 9,1 mm	30 x 32 mm
253641	380 x 12,2 mm	36 x 41 mm
254146	415 x 14,7 mm	41 x 46 mm
254650	465 x 15,7 mm	46 x 50 mm

Doppelringschlüssel

Double Ring Wrenches

Art.-Gruppe 123
Article Group 123

Doppelringschlüssel metrisch, nach DIN 838

Double Ring Wrenches, Metric

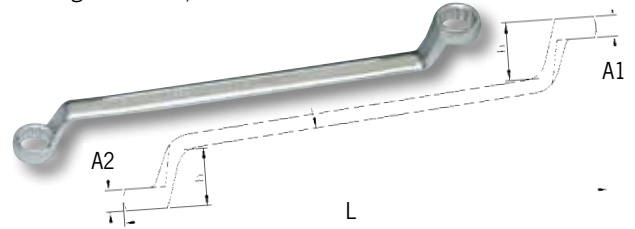

- ▶ Tief gekröpft 75°
- ▶ Vernickelt + verchromt matt satiniertes Oberflächenfinish
- ▶ 75° offset
- ▶ Nickel- and chromium-plated in satin mat finish

Art.-Nr./Art.-No.	L x A2 x A1	Größe/Size
240607	170 x 5,6 x 4,9 mm	6 x 7 mm
240809	182 x 6,8 x 6,0 mm	8 x 9 mm
241011	197 x 7,9 x 7,4 mm	10 x 11 mm
241013	213 x 8,9 x 8,4 mm	10 x 13 mm
241213	213 x 8,9 x 8,4 mm	12 x 13 mm
241317	250 x 8,9 x 11,4 mm	13 x 17 mm
241415	228 x 9,9 x 9,4 mm	14 x 15 mm
241617	246 x 10,9 x 10,4 mm	16 x 17 mm
241618	246 x 10,9 x 10,4 mm	16 x 18 mm
241719	265 x 11,9 x 11,4 mm	17 x 19 mm
241819	265 x 11,9 x 11,4 mm	18 x 19 mm
242022	288 x 12,9 x 12,4 mm	20 x 22 mm
242123	310 x 13,3 x 12,3 mm	21 x 23 mm
242426	330 x 14,3 x 13,7 mm	24 x 26 mm
242427	330 x 14,3 x 13,7 mm	24 x 27 mm
242528	348 x 14,7 x 14,2 mm	25 x 28 mm
243032	372 x 15,8 x 14,8 mm	30 x 32 mm
243641	570 x 18,0 x 19,5 mm	36 x 41 mm

Schraubenschlüssel

Wrenches

Art.-Gruppe 123
Article Group 123

Rohrsteckschlüssel leichte Ausführung

Double Ended Socket Wrenches

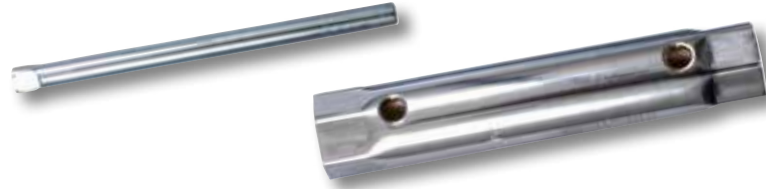

Art.-Nr./Art.-No.	Größe/Size
260607	6 x 7 mm
260809	8 x 9 mm
261011	10 x 11 mm
261213	12 x 13 mm
261415	14 x 15 mm
261617	16 x 17 mm
261719	17 x 19 mm

Art.-Nr./Art.-No.	Größe/Size
261819	18 x 19 mm
262022	20 x 22 mm
262123	21 x 23 mm
262427	24 x 27 mm
260001	Drehstift/Tommy Bar 146 mm (6 - 13 mm)
260002	Drehstift/Tommy Bar 146 mm (14 - 27 mm)

Sortiment auf Seite /Set on Page
H 148

Einmaulschlüssel nach DIN 894

Single Open End Wrench



- ▶ Aus extrem stabilem Stahl gefertigt
- ▶ Produced by special steel

Art.-Nr./Art.-No.	Länge/Length	Größe/Size
25244	195 mm	24 mm
25274	215 mm	27 mm
25304	240 mm	30 mm
25324	270 mm	32 mm
25364	295 mm	36 mm
25384	295 mm	38 mm
25414	335 mm	41 mm

Art.-Nr./Art.-No.	Länge/Length	Größe/Size
25424	335 mm	42 mm
25464	368 mm	46 mm
25484	410 mm	48 mm
25504	410 mm	50 mm
25554	490 mm	55 mm
25604	490 mm	60 mm
25654	490 mm	65 mm

Schraubenschlüssel

Wrenches

Art.-Gruppe 123
Article Group 123

PROFESSIONAL PLUS STANDARD

Offene Doppelringschlüssel Köpfe 15° abgewinkelt, nach DIN 3118, mattsatiniert verchromt

Flare Nut Wrenches

Head with 15°, Satin Mat Finish



Art.-Nr./Art.-No.	Größe/Size	Aufnahme/Drive
220810	8 x 10 mm	6 x 6-kant
220911	9 x 11 mm	6 x 6-kant
221011	10 x 11 mm	6 x 6-kant
221012	10 x 12 mm	6 x 6-kant
221214	12 x 14 mm	6 x 6-kant
221315	13 x 15 mm	12 x 12-kant
221417	14 x 17 mm	12 x 12-kant
221618	16 x 18 mm	12 x 12-kant
221719	17 x 19 mm	12 x 12-kant
221922	19 x 22 mm	12 x 12-kant
222224	22 x 24 mm	12 x 12-kant

Art.-Nr./Art.-No.	Größe/Size	Aufnahme/Drive
2203	3/8" x 7/16"	6 x 6-kant
2205	1/2" x 9/16"	6 x 6-kant
2207	11/16" x 3/4"	12 x 12-kant
2210	7/8" x 15/16"	12 x 12-kant

Sortimente auf Seite /Sets on Page
H 149 f.

PROFESSIONAL PLUS STANDARD

Rollgabelschlüssel nach DIN 3117

Adjustable Wrenches

- ▶ Gabelstellung 15°
- ▶ Mit Skala an der Maul-Seite
- ▶ Open end position 15°
- ▶ With scale at the open end side

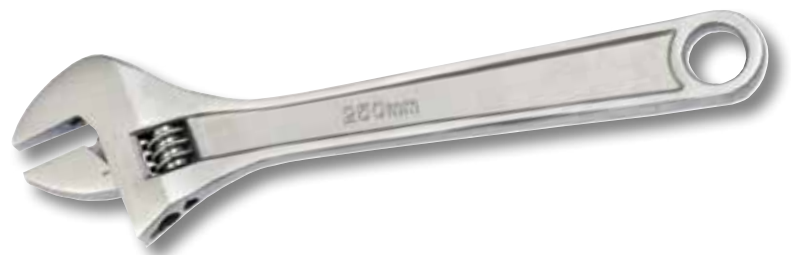

Art.-Nr./Art.-No.	Größe/Size	Länge/Length	max. Maulöffnung/max. Range
2404	4"	100 mm	13 mm
2406	6"	150 mm	19 mm
2408	8"	200 mm	24 mm
2410	10"	250 mm	30 mm
2412	12"	300 mm	34 mm
2415	15"	375 mm	44 mm

Schraubenschlüssel

Wrenches

Art.-Gruppe 123
Article Group 123

Automatischer Rollgabelschlüssel

Automatic Adjustable Wrenches

- ▶ **Selbständiges Anpassen an Schraubengrößen**
- ▶ **Automatisches Spannen durch entsprechende Drehbewegungen**
- ▶ **Integrierte Ratschenfunktion über Drehbewegung**
- ▶ **4 Größen passend für je 3 Schraubengrößen, metrisch und Zoll:**
8 – 10 / 11 – 13 / 14 – 16 / 17 – 19 mm
- ▶ **Auch passend für 4-kant, 12-kant, E-Torx**
- ▶ **Ideal für Sanitär und Automotive**

- ▶ *Automatic adjustment to screw sizes*
- ▶ *Automatic clamping by appropriate rotary motion*
- ▶ *Integrated ratchet function*
- ▶ *Every wrench fits to 3 screw sizes, metric and inch:*
8 – 10 / 11 – 13 / 14 – 16 / 17 – 19 mm
- ▶ *Also for square, 12-point, E-Torx*
- ▶ *Ideal for sanitary and automotive*

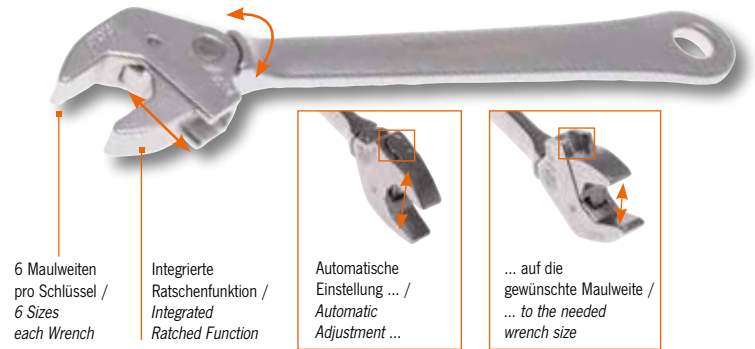

Art.-Nr./Art.-No.	Größe/Size	Länge/Length
2440810	8 - 9 - 10 mm + 5/16" - 11/32" - 3/8"	135 mm
2441113	11 - 12 - 13 mm + 7/16" - 16/32" - 1/2"	155 mm
2441416	14 - 15 - 16 - 16 mm + 9/16" - 19/32" - 5/8"	190 mm
2441719	17 - 18 - 19 mm + 11/16" - 23/32" - 3/4"	210 mm

Sortimente auf Seite / Sets on Page
H 151

Schraubenschlüssel

Wrenches

Art.-Gruppe 123
Article Group 123

PROFESSIONAL PLUS STANDARD

Gerüstbauerschlüssel, metrisch

Construction Wrenches, Metric

Das Ende des Handgriffs ist als Dorn ausgeführt und ermöglicht ein schnelles Justieren der Bauteile.

- ▶ Doppelseitige Knarre mit speziell gehärteten, durchgehenden Nüssen
- ▶ Langer Dorn zur optimalen Kraftübertragung
- ▶ Working with two sockets
- ▶ Sockets are extreme hard and with go-through-system



Art.-Nr./Art.-No.	Größe/Size	Art.-Nr./Art.-No.	Größe/Size
231013	10 x 13 mm	232427	24 x 27 mm
231317	13 x 17 mm	232430	24 x 30 mm
231719	17 x 19 mm	232732	27 x 32 mm
231922	19 x 22 mm	233236	32 x 36 mm
231924	19 x 24 mm		

PROFESSIONAL PLUS STANDARD

2319221

4-in-1 Gerüstbauerschlüssel mit Hammer und Nageleisen, 19 + 22 mm

4-in-1 Construction Wrench with Hammer and Nail Puller, 19 + 22 mm

- ▶ Mit ausgeschmiedetem Hammer und anklappbarem Nageleisen
- ▶ Größen 19 und 22 mm (in einem Schlüssel)
- ▶ Umschaltknarre, Spitzkegeldorn
- ▶ Langlebig aufgrund stabiler Ausführung

- ▶ With forged hammer and foldable nail puller
- ▶ Sizes 19 and 22 mm (in one wrench)
- ▶ Ratchet function, Taper Dorn
- ▶ Durable due to sturdy design

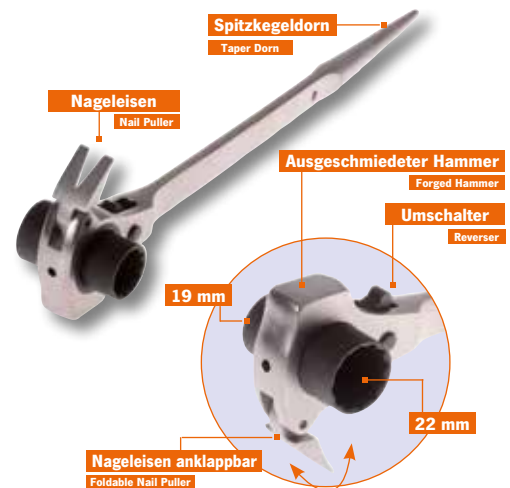

Art.-Nr./Art.-No.	Größe/Size
2319221	19 + 22 mm

PROFESSIONAL PLUS STANDARD

Pfeifenkopfschlüssel mit Bohrung metrisch, 12-kant x 6-kant

Through-Hole Open-Socket Wrenches, 12 point x 6 point

- ▶ Kurze Seite mit 12-kant Nuss
- ▶ Lange Seite mit 6-kant Nuss
- ▶ Short side with 12 point socket
- ▶ Long side with 6 point socket



Art.-Nr./Art.-No.	Größe/Size	Art.-Nr./Art.-No.	Größe/Size	Art.-Nr./Art.-No.	Größe/Size	Art.-Nr./Art.-No.	Größe/Size
2588-08	8 mm	2588-14	14 mm	2588-20	20 mm	2588-26*	26 mm
2588-09	9 mm	2588-15	15 mm	2588-21	21 mm	2588-27	27 mm
2588-10	10 mm	2588-16	16 mm	2588-22	22 mm	2588-28*	28 mm
2588-11	11 mm	2588-17	17 mm	2588-23*	23 mm	2588-29*	29 mm
2588-12	12 mm	2588-18	18 mm	2588-24	24 mm	2588-30	30 mm
2588-13	13 mm	2588-19	19 mm	2588-25*	25 mm	2588-32*	32 mm

*Lieferung nur solange der Vorrat reicht
*Delivery while stocks last

Ringgabelschlüssel Sätze

Combination Wrench Sets

Art-Gruppe 123
Article Group 123

PROFESSIONAL PLUS STANDARD

4421

**Ringgabelschlüssel Satz, 8-teilig
metrisch, nach DIN 3113 Form A,
in Kartonverpackung inkl. Cliphalter**

Combination Wrench Set, 8 pieces
Metric, Paper Box incl. Clip

8
tlg./pcs.

Inhalt/Contents:

je 1 Ringgabelschlüssel/Combination Wrench
8 - 9 - 10 - 11 - 13 - 14 - 17 - 19 mm

Art.-Nr./Art.-No.

4421 8-tlg./pcs.



PROFESSIONAL PLUS STANDARD

4422

**Ringgabelschlüssel Satz 12-teilig
metrisch, nach DIN 3113 Form A,
in Kartonverpackung inkl. Cliphalter**

Combination Wrench Set 12 pieces
Metric, Paper Box incl. Clip

12
tlg./pcs.

Inhalt/Contents:

je 1 Ringgabelschlüssel
6 - 7 - 8 - 9 - 10 - 11 - 12 - 13 - 14 - 15 - 17 - 19 mm

Art.-Nr./Art.-No.

4422 12-tlg./pcs.



PROFESSIONAL PLUS STANDARD

4408

**Ringgabelschlüssel Satz, metrisch,
nach DIN 3113 Form A, in Rolltasche**

Combination Wrench Set
Metric, in Pouch

14
tlg./pcs.

Inhalt/Contents:

je 1 Ringgabelschlüssel
8 - 10 - 11 - 12 - 13 - 14 - 15 - 16 - 17 - 18 - 19 - 20 - 21 - 22 mm

Art.-Nr./Art.-No.

4408 14-tlg./pcs.

4408E Rolltasche leer/empty



Ringgabelschlüssel Sätze

Combination Wrench Sets

Art-Gruppe 123
Article Group 123

PROFESSIONAL PLUS STANDARD

4410

**Ringgabelschlüssel Satz, metrisch
nach DIN 3113 Form A, in Rolltasche**

Combination Wrench Set,
Metric, in Pouch

23
tlg./pcs.

Inhalt/Contents:

je 1 Ringgabelschlüssel

6 - 7 - 8 - 9 - 10 - 11 - 12 - 13 - 14 - 15 - 16 - 17 - 18 - 19 - 20 - 21 -
22 - 24 - 25 - 26 - 27 - 30 - 32 mm

Art.-Nr./Art.-No.

4410 23-tlg./pcs.

4410E Rolltasche leer/Pouch empty



PROFESSIONAL PLUS STANDARD

4407

**Ringgabelschlüssel Satz, metrisch
nach DIN 3113 Form A, in Rolltasche**

Combination Wrench Set,
Metric, in Pouch

4
tlg./pcs.

Inhalt/Contents:

je 1 Ringgabelschlüssel

24 - 27 - 30 - 32 mm

Art.-Nr./Art.-No.

4407 4-tlg./pcs.

4407E Rolltasche leer/Pouch empty



PROFESSIONAL PLUS STANDARD

9961

**Ringgabelschlüssel Satz, metrisch
nach DIN 3113 Form A, in Rolltasche**

Combination Wrench Set,
Metric, in Pouch

14
tlg./pcs.

Inhalt/Contents:

je 1 Ringgabelschlüssel

6 - 7 - 8 - 9 - 10 - 11 - 12 - 13 - 14 - 15 - 16 - 17 - 18 - 19 mm

Art.-Nr./Art.-No.

9961 14-tlg./pcs.

3494E Rolltasche leer/Pouch empty



Ringgabelschlüssel Sätze lange Schlüssel

Combination Wrench Sets XL-Version

Art.-Gruppe 123
Article Group 123

PROFESSIONAL PLUS STANDARD

4436

Ringgabelschlüssel Satz, lange Schlüssel, metrisch, nach DIN 3113 Form A, in Rolltasche

Combination Wrench Set, XL, Metric, in Pouch

8
tlg./pcs.

Inhalt/Contents:

je 1 Ringgabelschlüssel
8 - 10 - 12 - 13 - 16 - 17 - 18 - 19 mm

Art.-Nr./Art.-No.

4436	8-tlg./pcs.
3499E	Rolltasche leer/Pouch empty



PROFESSIONAL PLUS STANDARD

4438

Ringgabelschlüssel Satz, lange Schlüssel, metrisch, nach DIN 3113 Form A, in Rolltasche

Combination Wrench Set, XL, Metric, in Pouch

14
tlg./pcs.

Inhalt/Contents:

je 1 Ringgabelschlüssel
8 - 10 - 11 - 12 - 13 - 14 - 15 - 16 - 17 - 18 - 19 - 20 - 21 - 22 mm

Art.-Nr./Art.-No.

4438	14-tlg./pcs.
4408E	Rolltasche leer/Pouch empty



PROFESSIONAL PLUS STANDARD

4437

Ringgabelschlüssel Satz, lange Schlüssel, metrisch, nach DIN 3113 Form A, in Rolltasche

Combination Wrench Set, XL, Metric, in Pouch

4
tlg./pcs.

Inhalt/Contents:

je 1 Ringgabelschlüssel 24 - 27 - 30 - 32 mm

Art.-Nr./Art.-No.

4437	4-tlg./pcs.
4407E	Rolltasche leer/Pouch empty



Ringgabelschlüssel Sätze

Combination Wrench Sets

Art.-Gruppe 123
Article Group 123

PROFESSIONAL PLUS STANDARD

2580

Ringgabelschlüssel Satz, Zoll, in Rolltasche

Combination Wrench Set,
Inch, in Pouch

Inhalt/Contents:

je 1 Ringgabelschlüssel

1/4" - 5/16" - 3/8" - 7/16" - 1/2" - 9/16" - 5/8" - 11/16" -
3/4" - 7/8" - 15/16" - 1"

12
tlg./pcs.



Art.-Nr./Art.-No.

2580	12-tlg./pcs.
2580E	Rolltasche, leer/Pouch empty

PROFESSIONAL PLUS STANDARD

4
tlg./pcs.

8
tlg./pcs.

4464* / 4466*

DOLPHIN Ringgabelschlüssel-Satz, metrisch in Rolltasche 90° verdrehte Schlüsselanordnung ermöglicht 25% höhere Kraftübertragung

DOLPHIN Combination Wrench Set, metric in Pouch
90° twisted wrench arrangement allows 25% higher power transmission

4464 Inhalt/Contents: je 1 DOLPHIN Schlüssel 10 - 13 - 17 - 19 mm

4466 Inhalt/Contents: je 1 DOLPHIN Schlüssel 8 - 9 - 10 - 11 - 13 - 14 - 17 - 19 mm

Art.-Nr./Art.-No.

4464*	4-tlg./pcs.
4466*	8-tlg./pcs.



PROFESSIONAL PLUS STANDARD

4
tlg./pcs.

8
tlg./pcs.

4462 / 4463

CLICKTECH Ratschen-Ringgabelschlüssel-Satz, metrisch in Rolltasche

CLICKTECH Ratchet Combination Wrench Set,
metric in Pouch

4462 Inhalt/Contents: je 1 CLICKTECH Schlüssel 10 - 13 - 17 - 19 mm

4463 Inhalt/Contents: je 1 CLICKTECH Schlüssel 8 - 10 - 12 - 13 - 16 - 17 - 18 - 19 mm

Art.-Nr./Art.-No.

4462	4-tlg./pcs.
4463	8-tlg./pcs.



*Lieferung nur solange der Vorrat reicht / *Delivery while stocks last

Doppelgabelschlüssel Sätze

Double Open End Wrench Sets

Art.-Gruppe 123
Article Group 123

PROFESSIONAL PLUS STANDARD

9988

Rohrsteckschlüssel Satz, leichte Ausführung in Rolltasche

Double Ended Socket Wrench Set,
Light Version in Pouch

10
tlg./pcs.

Inhalt/Contents:

je 1 Rohrsteckschlüssel

6x7 - 8x9 - 10x11 - 12x13 - 14x15 - 16x17 - 18x19 - 20x22,

Drehstift/tommy bar 146 mm (6 - 13 mm) + 146 mm (14 - 27mm)

Art.-Nr./Art.-No.

9988 10-tlg./pcs.

4405E Rolltasche, leer/Pouch empty



PROFESSIONAL PLUS STANDARD

4441

Doppelgabelschlüssel Satz, metrisch, nach DIN 3110, in Kartonverpackung inkl. Cliphalter

Double Open End Wrench Set,
Metric, Paper Box incl. Clip

6
tlg./pcs.

Inhalt/Contents:

je 1 Doppelgabelschlüssel

6 x 7 - 8 x 9 - 10 x 11 - 12 x 13 - 14 x 15 - 16 x 17 mm

Art.-Nr./Art.-No.

4441 6-tlg./pcs.



4405

Doppelgabelschlüssel Satz, metrisch, nach DIN 3110, in Rolltasche

Double Open End Wrench Set,
Metric, in Pouch

8
tlg./pcs.

Inhalt/Contents:

je 1 Doppelgabelschlüssel

6 x 7 - 8 x 9 - 10 x 11 - 12 x 13 - 14 x 15 - 16 x 17 -

18 x 19 - 20 x 22 mm

Art.-Nr./Art.-No.

4405 8-tlg./pcs.

4405E Rolltasche leer/Pouch empty



Doppelringschlüssel Sätze / Offener Doppelringschlüssel Satz

Double Ring Wrench Sets / Flare Nut Wrench Set

Art.-Gruppe 123
Article Group 123

PROFESSIONAL PLUS STANDARD

4442**Doppelgabelschlüssel Satz,
metrisch, nach DIN 3110,
in Kartonverpackung inkl. Cliphalter**Double Open End Wrench Set,
Metric, Paper Box incl. Clip**8**
tlg./pcs.**Inhalt/Contents:**je 1 Doppelgabelschlüssel 6 x 7 - 8 x 9 - 10 x 11 -
12 x 13 - 14 x 15 - 16 x 17 - 18 x 19 - 20 x 22 mm**Art.-Nr./Art.-No.**

4442 8-tlg./pcs.



PROFESSIONAL PLUS STANDARD

4411**Doppelgabelschlüssel Satz,
metrisch, nach DIN 3110, in Rolltasche**Double Open End Wrench Set,
Metric, in Pouch**11**
tlg./pcs.**Inhalt/Contents:**je 1 Doppelgabelschlüssel
6 x 7 - 8 x 9 - 10 x 11 - 12 x 13 - 14 x 15 - 16 x 17 - 18 x 19 -
20 x 22 - 21 x 23 - 24 x 27 - 30 x 32 mm**Art.-Nr./Art.-No.**4411 11-tlg./pcs.
4411E Rolltasche leer/empty**2216****Offener Doppelringschlüssel Satz,
in Rolltasche**Flare Nut Wrench Set,
Metric, in Pouch**6**
tlg./pcs.**Inhalt/Contents:**je 1 Doppelringschlüssel
8 x 10 - 9 x 11 - 12 x 14 - 13 x 15 - 17 x 19 - 22 x 24 mm**Art.-Nr./Art.-No.**2216 6-tlg./pcs.
2216E Rolltasche leer/empty

Doppelringschlüssel Sätze / Offener Doppelringschlüssel Satz

Double Ring Wrench Sets / Flare Nut Wrench Set

Art.-Gruppe 123
Article Group 123

PROFESSIONAL PLUS STANDARD

2218

Offener Doppelringschlüssel Satz, in Rolltasche

Flare Nut Wrench Set,
in Pouch

8
tlg./pcs.

Inhalt/Contents:

je 1 Doppelringschlüssel
9 x 11 - 10 x 12 - 13 x 15 - 14 x 17 mm
3/8" x 7/16" - 1/2" x 9/16" - 11/16" x 3/4" - 7/8" x 15/16"

Art.-Nr./Art.-No.

2218	8-tlg./pcs.
2218E	Rolltasche leer/empty



PROFESSIONAL PLUS STANDARD

4451

Doppelringschlüssel Satz, metrisch, nach DIN 838, in Kartonverpackung inkl. Cliphalter

Double Ring Wrench Set,
Metric, Paper Box incl. Clip

6
tlg./pcs.

Inhalt/Contents:

je 1 Doppelringschlüssel
6 x 7 - 8 x 9 - 10 x 11 - 12 x 13 - 14 x 15 - 16 x 17 mm

Art.-Nr./Art.-No.

4451	6-tlg./pcs.
------	-------------



PROFESSIONAL PLUS STANDARD

4402

Doppelringschlüssel Satz, metrisch, nach DIN 838, in Rolltasche

Double Ring Wrench Set,
Metric, in Pouch

8
tlg./pcs.

Inhalt/Contents:

je 1 Doppelringschlüssel
6 x 7 - 8 x 9 - 10 x 11 - 12 x 13 - 14 x 15 - 16 x 17 - 18 x 19 -
20 x 22 mm

Art.-Nr./Art.-No.

4402	8-tlg./pcs.
4402E	Rolltasche leer/empty



Doppelringschlüssel Sätze / Automatischer Rollgabelschlüssel Satz

Double Ring Wrench Sets / Automatic Adjustable Wrench Set

Art.-Gruppe 123
Article Group 123

PROFESSIONAL PLUS STANDARD

4452

Doppelringschlüssel Satz, metrisch, nach DIN 838, in Kartonverpackung inkl. Cliphalter

Double Ring Wrench Set,
Metric, Paper Box incl. Clip

Inhalt/Contents:

je 1 Doppelringschlüssel
6 x 7 - 8 x 9 - 10 x 11 - 12 x 13 - 14 x 15 - 16 x 17 -
18 x 19 - 20 x 22 mm

8
tlg./pcs.



Art.-Nr./Art.-No.

4452 8-tlg./pcs.

PROFESSIONAL PLUS STANDARD

4403

Doppelringschlüssel Satz, metrisch, nach DIN 838, in Rolltasche

Double Ring Wrench Set,
Metric, in Pouch

Inhalt/Contents:

je 1 Doppelringschlüssel
21 x 23 - 24 x 27 - 25 x 28 - 30 x 32 mm

4
tlg./pcs.



Art.-Nr./Art.-No.

4403 4-tlg./pcs.

4403E Rolltasche leer/empty

PROFESSIONAL PLUS STANDARD

4468

Automatischer Rollgabelschlüssel Satz, in Rolltasche

Automatic Adjustable Wrench Set,
in Pouch

Inhalt/Contents:

je 1 Automatischer Rollgabelschlüssel
8 - 9 - 10 mm + 5/16" - 11/32" - 3/8"
11 - 12 - 13 mm + 7/16" - 16/32" - 1/2"
14 - 15 - 16 mm + 9/16" - 19/32" - 5/8"
17 - 18 - 19 mm + 11/16" - 23/32" - 3/4"

4
tlg./pcs.



Art.-Nr./Art.-No.

4468 4-tlg./pcs.

4468E Rolltasche leer/empty



Technische Daten

Technical Details

Vergleichsliste

Gewinde zu Schlüsselweite (SW) / Checklist Thread To Wrench Size

Gewinde/Thread (norm. Reihe)	SW/Size
M2	4
M2,5	5
M3	5,5
M4	7
M5	8
M6	10
M8	13
M10	17 (16)
M12	19 (18)
M14	21 (22)
M16	24
M18	27
M20	30
M22	32 (34)
M24	36
M27	41
M30	46
M33	50
M36	55
M39	60
M42	65
M45	70
M48	75
M52	80

Schlüsselweiten-Toleranzen

Auszug aus DIN 475 Teil 2 / Wrench Size Tolerances

Nennmaß/Nom. Dim.	min.	max.
3,5	3,52	3,60
4*	4,02	4,12
4,5	4,52	4,62
5*	5,02	5,12
5,5*	5,52	5,62
6*	6,03	6,15
7*	7,03	7,15
8*	8,03	8,15
9*	9,03	9,15
10*	10,04	10,19
11*	11,04	11,19
12*	12,04	12,24
13*	13,04	13,24
14*	14,05	14,27
15*	15,05	15,27
16*	16,05	16,27
17*	17,05	17,30
18*	18,05	18,30
19*	19,06	19,36
20*	20,06	20,36
21*	21,06	21,36
22*	22,06	22,36
23*	23,06	23,36
24*	24,06	24,36
25*	25,06	25,36
26*	26,08	26,48
27*	27,08	27,48
28*	28,08	28,48
30*	30,08	30,48
32*	32,08	32,48
34*	34,10	34,60
36*	36,10	36,60
41*	41,10	41,60
46*	46,10	46,60
50*	50,10	50,60
55*	55,12	55,72
60*	60,12	60,72
65*	65,12	65,72
70*	70,12	70,72
75*	75,15	75,85
80*	80,15	80,85

Umrechnungstabelle

Zoll zu Metrisch / Conversion Table: Inch To Metric

Zoll/Inch	metrisch/metric (Ca.-Werte)
5/16"	7,938
3/8"	9,525
7/16"	11,113
1/2"	12,700
9/16"	14,288
5/8"	15,875
11/16"	17,463
3/4"	19,050
13/16"	20,638
7/8"	22,225
15/16"	23,813
1"	25,400
1 1/16"	26,987
1 1/8"	28,575
1 1/4"	31,750
1/64"	0,397
1/32"	0,794
3/64"	1,191
1/16"	1,588
5/64"	1,984
3/32"	2,381
1/8"	3,175
3/16"	4,763
1/4"	6,350
1 1/64"	25,797
1 1/32"	26,194
1 3/64"	26,591
1 5/64"	27,384
1 3/32"	27,781
1 3/16"	30,162
1 5/16"	33,337
1 3/8"	34,925
1 7/16"	36,512
1 1/2"	38,100
1 9/16"	39,687
1 5/8"	41,275
1 11/16"	42,862
1 3/4"	44,450
1 13/16"	46,037
1 7/8"	47,625
1 15/16"	49,212
2"	50,800
2 1/4"	57,150
2 1/2"	63,500
2 3/4"	69,850

Die durch * gekennzeichneten Schlüsselweiten entsprechen internationalen Normen.
Die Schlüsselweiten 6, 9, 12, 14, 17, 19, 20, 22, 23, 25, 26, 28 und 32 sind in dem ISO/DIN 691 eingeklammert und als Übergangswerte bezeichnet.
*Wrench sizes marked by * correspond to international standards. The wrench sizes 6, 9, 12, 14, 17, 19, 20, 22, 23, 25, 26, 28 and 32 are bracketed in the ISO/DIN 691 and referred to as transitional values.*









Bit-Programm

Bits



Übersicht Bit-Boxen Summary Bit Boxes

2

Auf Seite / On Page	Qualität / Quality			Bit-Länge / Bit length		Antriebsart / Drive Type														Zubehör / Accessories												
	PROFESSIONAL	PLUS	STANDARD	Teile / Pieces	25 mm	75 mm	Schlitz / Slotted	Phillips / PH	Pozidriv / PZ	TORX* / TX	TORX* mit Bohrung / Tamper TORX®	Inbus/Hex	Inbus mit Bohrung / Tamper Hex	Robertson / Robertson	Torq / Torq	Tri-Wing / Tri-Wing	Spanner / Spanner	Clutch / Clutch	Vielzahn / Spline	5-Stern mit Bohrung / 5-Star Tamper	Stecknuss Bits / Bit Sockets	Bit-Adapter / Bit Adapter	Eindreh-Bit für Haken / Hook Driver	Stecknuss-Adapter / Socket Adapter	Mini-Bit-Knarre / Mini Ratchet Handle	Bit-Magnethalter / Magnetic Bit Holder	Magneth. m. Schneispannhülse / Magneth. Bit-Holder Quick release	(Ratschen-)Schraubendreher / (Ratchet) Screwdriver	Verkaufsdisplay / Display			
 1/4" Color-Bit-Box / 1/4" Color Bit Set Art.-Nr./Art.-No. 4093 B x L x H/W x L x H: 155 x 120 x 35 mm Gewicht/Weight: 490 g	H 177	+		18	+	+	+	+	+	+	+																				+	
 1/4" Bit-Box mit Drehgriffknarre/ 1/4" Bit Set with Twist Handle Ratchet Art.-Nr./Art.-No. 394073 B x L x H/W x L x H: 200 x 120 x 40 mm Gewicht/Weight: 620 g	H 179		+	32	+	+	+	+	+	+	+										+		+	+								
 1/4" SECURIBIT-Box / 1/4" SECURIBIT-Set Art.-Nr./Art.-No. 3790 B x L x H/W x L x H: 193 x 137 x 36 mm Gewicht/Weight: 900 g	H 180		+	50	+	+	+	+	+	+	+	+	+	+	+	+	+	+	+	+							+					
 1/4" Bit Box 75 mm / 1/4" Bit Set 75 mm Art.-Nr./Art.-No. 3788 B x L x H/W x L x H: 190 x 130 x 36 mm Gewicht/Weight: 720 g	H 180		+	36	+	+	+	+	+	+	+																+					
 1/4" SECURIBIT-Box / 1/4" SECURIBIT-Set Art.-Nr./Art.-No. 3789 B x L x H/W x L x H: 220 x 155 x 50 mm Gewicht/Weight: 1.160 g	H 181		+	122	+		+	+	+	+	+	+	+	+	+	+	+	+	+	+	+	+	+	+	+	+	+	+	+	+	+	
 1/4" SECURIBIT-Box / 1/4" SECURIBIT-Set Art.-Nr./Art.-No. 3787 B x L x H/W x L x H: 190 x 130 x 36 mm Gewicht/Weight: 700 g	H 181		+	100	+		+	+	+	+	+	+	+	+	+	+	+	+	+	+		+	+	+		+						
 1/4" Bit Box XL / 1/4" Bit Set XL Art.-Nr./Art.-No. 8604 B x L x H/W x L x H: 120 x 205 x 45 mm Gewicht/Weight: 1.120 g	H 182		+	113	+	+	+	+	+	+	+															+	+					
 1/4" Bit Box XXL / 1/4" Bit Set XXL Art.-Nr./Art.-No. 8606 B x L x H/W x L x H: 335 x 200 x 45 mm Gewicht/Weight: 2.000 g	H 183		+	200	+	+	+	+	+	+	+	+	+	+	+	+	+	+	+	+			+		+	+						

Bit-Programm

Bit-Range



PROFESSIONAL PLUS STANDARD

PROFESSIONAL-Bits

- ▶ Höchste Passgenauigkeit und spezielle Härtung – sehr lange Lebensdauer und hochwertige Verschraubung
- ▶ Empfohlen für den professionellen Anwender
- ▶ Color-Ring-Bits, TiN-Bits, ACR-Bits, Diamant-Bits, Torsion-Bits
- ▶ Bester Rundlauf für ermüdungsfreies und schnelles Arbeiten
- ▶ Aus hochwertigstem S2-Spezialstahl gefertigt
- ▶ Große Auswahl an Einzelbits und Bitboxen

- ▶ *Best fitting accuracy and special hardening – gives extra long life and high class screw joint*
- ▶ *Recommended for professional use*
- ▶ *Color-Ring-Bits, TiN-Bits, ACR Bits, Diamant-Bits, Torsion-Bits*
- ▶ *Effortless and fast screwing*
- ▶ *Produced of high-performance S2-Steel*
- ▶ *Big product range of Bits and Bit-Boxes*



Color-Bits

- ▶ Dank Farbleitsystem immer schnell den richtigen Bit
- ▶ *Color ring helps to find the right bit easily*



TiN-Bits

- ▶ Extrem harte Titan-Nitrit-Beschichtung – höhere Oberflächenhärte und Zähigkeit des Bits
- ▶ Weniger Verschleiß am Bit und weniger Schäden an Schraubenköpfen
- ▶ *Titan-Nitrite-Coating – higher surface hardness and resistance of the bits*
- ▶ *Less wear at the bit as well as damage at the screws*



ACR-Bits (Anti-Cam-Out-Ribs)

- ▶ Rippen an der Antriebsspitze reduzieren das Herausrutschen des Bits aus der Schraube
- ▶ Sauberes Verschraubungsergebnis u. weniger Verschleiß an Werkzeug u. Schraube
- ▶ *Ribs at the tip of the bit reduce the risk of the "Cam-out-effect"*
- ▶ *High class work result*
- ▶ *Less wear at the tool and screw*



Diamant-Bits

- ▶ Mit Diamantpartikeln besetzte Antriebsspitze minimiert das Herausrutschen des Bits aus der Schraube
- ▶ Sicheres Verschrauben auf empfindlichen Oberflächen
- ▶ Ergonomischeres Arbeiten durch Reduzierung des Anpressdruckes
- ▶ Sauberes Verschraubungsergebnis und weniger Verschleiß
- ▶ *Diamond coated bit tip minimize the "Cam-out-effect"*
- ▶ *Safer screw driving on sensitive surfaces*
- ▶ *Less fatiguing work due to the reducing of contact pressure*
- ▶ *High class work result, less wear at the tool and screw*



Torsions-Bits

- ▶ Für höchste Belastung durch Hochleistungs-Spezialstahl ausgelegt
- ▶ Ideal für Schlagschrauber geeignet
- ▶ Spezielle Torsionszone leitet die Belastung der Bohrspitze in den Bit ab
- ▶ Reduzierung des Herausrutschens des Bits durch ACR-Profile
- ▶ *Produced of high-performance Steel – designed for maximum forces*
- ▶ *Especially suitable for use with impact drivers*
- ▶ *Special designed torsion zone absorbs forces into the bit*
- ▶ *Additional with Cam-out-rips*



PROFESSIONAL PLUS STANDARD

PLUS-Bits

- ▶ Erstklassiger Passsitz auf Grund sorgfältiger Verarbeitung auf modernen Produktionsanlagen
- ▶ Hervorragender Rundlauf für ermüdungsfreies und schnelles Arbeiten
- ▶ Aus hochwertigem S2-Spezialstahl gefertigt, ideal für den professionellen Anwender geeignet
- ▶ Breites Produktsortiment aus Einzelbits und Bitboxen – für jede Anwendung den richtigen Bit
- ▶ *Outstanding fit because of good workmanship on high technical machines*
- ▶ *Effortless and fast screwing*
- ▶ *Produced of S2-Steel, optimal for professional use*
- ▶ *Wide product range of Bits and Bit-Boxes – for every application the right bit*



PROFESSIONAL PLUS STANDARD

Standard-Bits

- ▶ Sehr guter Passsitz und Rundlauf für professionelle Einsätze
- ▶ Aus CR-V Stahl gefertigt
- ▶ Große Auswahl an Bit-Boxen

- ▶ *Good fit and concentricity for professional use*
- ▶ *Produced of CR-V steel*
- ▶ *Wide product range of Bit-Boxes*



1/4" BIT- Schraubendreher Einsätze

1/4" Bits



Art.-Gruppe 130
Article Group 130

PROFESSIONAL **PLUS** STANDARD

1/4" Schraubendreher-Einsätze für Kreuzschlitz-Schrauben Phillips

Phillips Bits



Art.-Nr./Art.-No.	Größe/Size	Länge/Length
2701	PH 1	25 mm
2702	PH 2	25 mm
2703	PH 3	25 mm
2704	PH 4	25 mm
2801	PH 1	50 mm
2802	PH 2	50 mm
2803	PH 3	50 mm
2804	PH 4	50 mm
2901	PH 1	90 mm
2902	PH 2	90 mm
2903	PH 3	90 mm
2601	PH 1	150 mm
2602	PH 2	150 mm
2603	PH 3	150 mm
3002	PH 2	300 mm
2706	PH 2	extra schmal 25 mm
2707	2x PH 2	Tiefenstopp 25 mm
2708	PH 2	Tiefenstopp 25 mm

PROFESSIONAL **PLUS** STANDARD

3701	PH 1	TiN 25 mm
3702	PH 2	TiN 25 mm
3703	PH 3	TiN 25 mm

PROFESSIONAL **PLUS** STANDARD



Art.-Nr./Art.-No.	Größe/Size	Länge/Length
2707	2x PH 2	Tiefenstopp 25 mm
2708	PH 2	Tiefenstopp 25 mm

PROFESSIONAL **PLUS** STANDARD

1/4" ACR Schraubendreher-Einsätze für Kreuzschlitz-Schrauben Phillips

ACR Phillips Bits

10er Pack ACR Bits

10 pcs Box ACR Bits



Art.-Nr./Art.-No.	Größe/Size	Länge/Length
3001-10	PH 1	25 mm
3002-10	PH 2	25 mm
3003-10	PH 3	25 mm
3101-10	PH 1	50 mm
3102-10	PH 2	50 mm
3103-10	PH 3	50 mm

PROFESSIONAL **PLUS** STANDARD

ACR Bits lose

ACR Bits Bulk



Art.-Nr./Art.-No.	Größe/Size	Länge/Length
3201	PH 1	70 mm
3202	PH 2	70 mm
3203	PH 3	70 mm

PROFESSIONAL **PLUS** STANDARD

1/4" Schraubendreher-Einsätze 100er Pack für Kreuzschlitz-Schrauben Phillips

Phillips Bits 100 pcs Box



Art.-Nr./Art.-No.	Größe/Size	Länge/Length
2701-100	PH 1	25 mm
2702-100	PH 2	25 mm
2703-100	PH 3	25 mm

PROFESSIONAL **PLUS** STANDARD

1/4" Schraubendreher-Einsätze 10er Pack für Kreuzschlitz-Schrauben Phillips

Phillips Bits

10pcs Box



Art.-Nr./Art.-No.	Größe/Size	Länge/Length
2700-10	PH 0	25 mm
2701-10	PH 1	25 mm
2702-10	PH 2	25 mm
2703-10	PH 3	25 mm
2704-10	PH 4	25 mm
2801-10	PH 1	50 mm
2802-10	PH 2	50 mm
2803-10	PH 3	50 mm

PROFESSIONAL **PLUS** STANDARD

Extra schmal

Reduced Nose



Art.-Nr./Art.-No.	Größe/Size	Länge/Length
2706	PH 2	extra schmal 25 mm

1/4" BIT- Schraubendreher Einsätze

1/4" Bits



Art.-Gruppe 130
Article Group 130

PROFESSIONAL PLUS STANDARD

1/4" Schraubendreher-Einsätze für Kreuzschlitz-Schrauben Pozidriv

Pozidriv Bits



Art.-Nr./Art.-No.	Größe/Size	Länge/Length
2711	PZ 1	25 mm
2712	PZ 2	25 mm
2713	PZ 3	25 mm
2714	PZ 4	25 mm
2811	PZ 1	50 mm
2812	PZ 2	50 mm
2813	PZ 3	50 mm
2814	PZ 4	50 mm
2911	PZ 1	90 mm
2912	PZ 2	90 mm
2913	PZ 3	90 mm
2611	PZ 1	150 mm
2612	PZ 2	150 mm
2613	PZ 3	150 mm
3012	PZ 2	300 mm

PROFESSIONAL PLUS STANDARD

3711	PZ 1	TiN 25 mm
3712	PZ 2	TiN 25 mm
3713	PZ 3	TiN 25 mm

PROFESSIONAL PLUS STANDARD

1/4" ACR Schraubendreher-Einsätze für Kreuzschlitz-Schrauben Pozidriv

ACR Pozidriv Bits

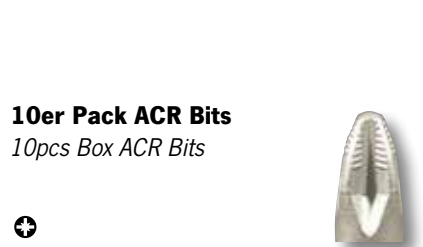

10er Pack ACR Bits

10pcs Box ACR Bits

Art.-Nr./Art.-No.	Größe/Size	Länge/Length
3011-10	PZ 1	25 mm
3012-10	PZ 2	25 mm
3013-10	PZ 3	25 mm
3111-10	PZ 1	50 mm
3112-10	PZ 2	50 mm
3113-10	PZ 3	50 mm

PROFESSIONAL PLUS STANDARD

1/4" ACR Bits lose

ACR Bits Bulk

Art.-Nr./Art.-No.	Größe/Size	Länge/Length
3211	PZ 1	70 mm
3212	PZ 2	70 mm
3213	PZ 3	70 mm

PROFESSIONAL PLUS STANDARD

1/4" Schraubendreher-Einsätze 10er Pack für Kreuzschlitz-Schrauben Pozidriv

Pozidriv Bits 10pcs Box



Art.-Nr./Art.-No.	Größe/Size	Länge/Length
2710-10	PZ 0	25 mm
2711-10	PZ 1	25 mm
2712-10	PZ 2	25 mm
2713-10	PZ 3	25 mm
2714-10	PZ 4	25 mm
2811-10	PZ 1	50 mm
2812-10	PZ 2	50 mm
2813-10	PZ 3	50 mm

PROFESSIONAL PLUS STANDARD

1/4" Schraubendreher-Einsätze 100er Pack für Kreuzschlitz-Schrauben Pozidriv

Pozidriv Bits 100 pcs Box



Art.-Nr./Art.-No.	Größe/Size	Länge/Length
2711-100	PZ 1	25 mm
2712-100	PZ 2	25 mm
2713-100	PZ 3	25 mm

1/4" BIT- Schraubendreher Einsätze

1/4" Bits



Art-Gruppe 130
Article Group 130

PROFESSIONAL **PLUS** STANDARD

1/4" Schraubendreher-Einsätze für Schlitz-Schrauben

Slotted Bits



Art.-Nr./Art.-No.	Größe/Size	Länge/Length
2721	4,0 mm	25 mm
2722	4,5 mm	25 mm
2727	5,0 mm	25 mm
2723	5,5 mm	25 mm
2724	6,0 mm	25 mm
2725	6,5 mm	25 mm
2726	8,0 mm	25 mm
2821	4,0 mm	50 mm
2822	4,5 mm	50 mm
2823	5,5 mm	50 mm
2824	6,0 mm	50 mm
2825	6,5 mm	50 mm
2826	8,0 mm	50 mm
3221	4,0 mm	70 mm
3222	4,5 mm	70 mm
3223	5,5 mm	70 mm
3224	6,0 mm	70 mm
3225	6,5 mm	70 mm
3226	8,0 mm	70 mm
2921	4,0 mm	90 mm
2922	4,5 mm	90 mm
2923	5,5 mm	90 mm
2924	6,0 mm	90 mm
2925	6,5 mm	90 mm
2926	8,0 mm	90 mm

PROFESSIONAL **PLUS** STANDARD

1/4" Schraubendreher-Einsätze 10er Pack für Schlitz-Schrauben

Slotted Bits 10 pcs Box



Art.-Nr./Art.-No.	Größe/Size	Länge/Length
2721-10	4,0 mm	25 mm
2722-10	4,5 mm	25 mm
2723-10	5,5 mm	25 mm
2724-10	6,0 mm	25 mm
2725-10	6,5 mm	25 mm
2726-10	8,0 mm	25 mm

1/4" BIT- Schraubendreher Einsätze

1/4" Bits



Art.-Gruppe 130
Article Group 130

PROFESSIONAL PLUS STANDARD

1/4" Schraubendreher-Einsätze für Innen-TX-Schrauben

TX Bits



Art.-Nr./Art.-No.	Größe/Size	Länge/Length
2728	T6	25 mm
2729	T7	25 mm
2738	T8	25 mm
2739	T9	25 mm
2731	T10	25 mm
2732	T15	25 mm
2733	T20	25 mm
2734	T25	25 mm
2737	T27	25 mm
2735	T30	25 mm
2736	T40	25 mm
2831	T10	50 mm
2832	T15	50 mm
2833	T20	50 mm
2834	T25	50 mm
2837	T27	50 mm
2835	T30	50 mm
2836	T40	50 mm
3228	T6	70 mm
3229	T7	70 mm
3238	T8	70 mm
3239	T9	70 mm
3231	T10	70 mm
3232	T15	70 mm
3233	T20	70 mm
3234	T25	70 mm
3237	T27	70 mm
3235	T30	70 mm
3236	T40	70 mm
3274	T45	70 mm
3275	T50	70 mm

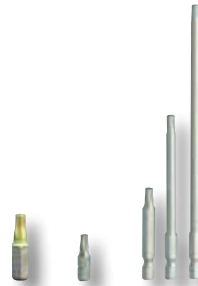

Art.-Nr./Art.-No.	Größe/Size	Länge/Length
2931	T10	90 mm
2932	T15	90 mm
2933	T20	90 mm
2934	T25	90 mm
2937	T27	90 mm
2935	T30	90 mm
2936	T40	90 mm
2631	T10	150 mm
2632	T15	150 mm
2633	T20	150 mm
2634	T25	150 mm
2637	T27	150 mm
2635	T30	150 mm
2636	T40	150 mm
3031	T10	300 mm
3032	T15	300 mm
3033	T20	300 mm
3034	T25	300 mm
3035	T30	300 mm
3036	T40	300 mm

PROFESSIONAL PLUS STANDARD

3731	T10	TiN 25 mm
3732	T15	TiN 25 mm
3733	T20	TiN 25 mm
3734	T25	TiN 25 mm
3737	T27	TiN 25 mm
3735	T30	TiN 25 mm
3736	T40	TiN 25 mm

PROFESSIONAL PLUS STANDARD

1/4" Konische Schraubendreher-Einsätze 10er Pack für Innen-TX-Schrauben

1/4" TX Align-Tapered Bits



Die Bits laufen konisch zu, werden in die Schraube gedrückt und sind somit fest mit der Schraube verbunden.

The bit will fix in the screw and so the screw would not get loose.



Art.-Nr./Art.-No.	Größe/Size	Länge/Length
3030-10	T6W	25 mm
3031-10	T7W	25 mm
3032-10	T8W	25 mm
3033-10	T9W	25 mm
3034-10	T10W	25 mm
3035-10	T15W	25 mm
3036-10	T20W	25 mm
3037-10	T25W	25 mm
3038-10	T27W	25 mm
3039-10	T30W	25 mm
3040-10	T40W	25 mm
3130-10	T6W	50 mm
3131-10	T7W	50 mm
3132-10	T8W	50 mm
3133-10	T9W	50 mm
3134-10	T10W	50 mm
3135-10	T15W	50 mm
3136-10	T20W	50 mm
3137-10	T25W	50 mm
3138-10	T27W	50 mm
3139-10	T30W	50 mm
3140-10	T40W	50 mm

1/4" BIT- Schraubendreher Einsätze

1/4" Bits



Art-Gruppe 130
Article Group 130

PROFESSIONAL **PLUS** STANDARD

**1/4" Schraubendreher-Einsätze
10er Pack für
Innen-TX-Schrauben**
TX Bits 10 pcs Box



Art.-Nr./Art.-No.	Größe/Size	Länge/Length
2727-10	T5	25 mm
2728-10	T6	25 mm
2729-10	T7	25 mm
2738-10	T8	25 mm
2739-10	T9	25 mm
2731-10	T10	25 mm
2732-10	T15	25 mm
2733-10	T20	25 mm
2734-10	T25	25 mm
2737-10	T27	25 mm
2735-10	T30	25 mm
2736-10	T40	25 mm
2771-10	T45	25 mm
2772-10	T50	25 mm
2831-10	T10	50 mm
2832-10	T15	50 mm
2833-10	T20	50 mm
2834-10	T25	50 mm
2837-10	T27	50 mm
2835-10	T30	50 mm
2836-10	T40	50 mm
2774-10	T45	50 mm
2775-10	T50	50 mm

PROFESSIONAL **PLUS** STANDARD

**1/4" Schraubendreher-Einsätze
100er Pack für
Innen-TX-Schrauben**
TX Bits 100 pcs Box



Art.-Nr./Art.-No.	Größe/Size	Länge/Length
2731-100	T10	25 mm
2732-100	T15	25 mm
2733-100	T20	25 mm
2734-100	T25	25 mm
2735-100	T30	25 mm
2736-100	T40	25 mm

PROFESSIONAL **PLUS** STANDARD

**1/4" 5-Stern
Schraubendreher-Einsätze
mit stirnseitiger Bohrung**
5-star Tamper Bits



Art.-Nr./Art.-No.	Größe/Size	Länge/Length
2881	TS10	25 mm
2882	TS15	25 mm
2883	TS20	25 mm
2884	TS25	25 mm
2885	TS27	25 mm
2886	TS30	25 mm
2887	TS40	25 mm

PROFESSIONAL **PLUS** STANDARD

**1/4" Schraubendreher-Einsätze für
Innen-TX-Schrauben mit stirnseitiger
Bohrung**
Tamper TX Bits



Art.-Nr./Art.-No.	Größe/Size	Länge/Length
2747	T7	25 mm
2748	T8	25 mm
2749	T9	25 mm
2751	T10	25 mm
2752	T15	25 mm
2753	T20	25 mm
2754	T25	25 mm
2755	T27	25 mm
2756	T30	25 mm
2757	T40	25 mm
2777-10	T45 (10er Pack)	25 mm
2778-10	T50 (10er Pack)	25 mm
2851	T10	50 mm
2852	T15	50 mm
2853	T20	50 mm
2854	T25	50 mm
2855	T27	50 mm
2856	T30	50 mm
2857	T40	50 mm
2961	T10	90 mm
2962	T15	90 mm
2963	T20	90 mm
2964	T25	90 mm
2758	Set T10-T40/7-tlg.	25 mm

1/4" BIT- Schraubendreher Einsätze

1/4" Bits

**Art.-Gruppe 130**
Article Group 130**1/4" Schraubendreher-Einsätze
für Innensechskant-Schrauben**

Hex Bits

**1/4" Schraubendreher-Einsätze
10er Pack für
Innensechskant-Schrauben**

Hex Bits 10 pcs Box

**1/4" Schraubendreher-Einsätze
für Innensechskant-Schrauben mit
stirnseitiger Bohrung**

Tamper Hex Bits



Art.-Nr./Art.-No.	Größe/Size	Länge/Length
2696	1,5 mm	25 mm
2697	2,0 mm	25 mm
2698	2,5 mm	25 mm
2741	3,0 mm	25 mm
2742	4,0 mm	25 mm
2743	5,0 mm	25 mm
2699	5,5 mm	25 mm
2744	6,0 mm	25 mm
2745	7,0 mm	25 mm
2746	8,0 mm	25 mm



Art.-Nr./Art.-No.	Größe/Size	Länge/Length
2741-10	3,0 mm	25 mm
2742-10	4,0 mm	25 mm
2743-10	5,0 mm	25 mm
2744-10	6,0 mm	25 mm
2745-10	7,0 mm	25 mm
2746-10	8,0 mm	25 mm



Art.-Nr./Art.-No.	Größe/Size	Länge/Length
2676	2,0 mm	25 mm
2677	2,5 mm	25 mm
2678	3,0 mm	25 mm
2679	4,0 mm	25 mm
2680	5,0 mm	25 mm
2681	6,0 mm	25 mm
2683	5/32"	25 mm
2684	9/64"	25 mm
2685	1/8"	25 mm
2686	7/64"	25 mm
2687	3/32"	25 mm
2688	5/64"	25 mm

2841	3,0 mm	50 mm
2842	4,0 mm	50 mm
2843	5,0 mm	50 mm
2844	6,0 mm	50 mm
2845	7,0 mm	50 mm
2846	8,0 mm	50 mm

3247	1,5 mm	70 mm
3248	2,0 mm	70 mm
3249	2,5 mm	70 mm
3241	3,0 mm	70 mm
3242	4,0 mm	70 mm
3243	5,0 mm	70 mm

3041	3,0 mm	300 mm
3042	4,0 mm	300 mm
3043	5,0 mm	300 mm
3044	6,0 mm	300 mm
3045	7,0 mm	300 mm
3046	8,0 mm	300 mm

3093	5/32"	300 mm
3094	9/64"	300 mm
3095	1/8"	300 mm
3096	7/64"	300 mm
3097	3/32"	300 mm
3098	5/64"	300 mm

**1/4" Schraubendreher-Einsätze
mit Kugelkopf 10er Pack für
Innensechskant-Schrauben**

Ball Point Bits 10 pcs Box



Art.-Nr./Art.-No.	Größe/Size	Länge/Length
2780-10	1,5 mm	25 mm
2781-10	2,0 mm	25 mm
2782-10	2,5 mm	25 mm
2783-10	3,0 mm	25 mm
2784-10	4,0 mm	25 mm
2785-10	5,0 mm	25 mm
2786-10	6,0 mm	25 mm
2787-10	7,0 mm	25 mm
2788-10	8,0 mm	25 mm

1/4" BIT- Schraubendreher Einsätze 300 mm

1/4" Bits 300 mm

**Art.-Gruppe 130**
Article Group 130**Extra lange Ausführung**

Extra long Version

**1/4" Schraubendreher-Einsätze
für Kreuzschlitz-Schrauben Phillips**

Phillips Bits



Art.-Nr./Art.-No.	Größe/Size	Länge/Length
3002	PH 2	300 mm

**1/4" Schraubendreher-Einsätze
für Kreuzschlitz-Schrauben Pozidriv**

Pozidriv Bits



Art.-Nr./Art.-No.	Größe/Size	Länge/Length
3012	PZ 2	300 mm

**1/4" Schraubendreher-Einsätze
für Innen-TX-Schrauben**

TX Bits



Art.-Nr./Art.-No.	Größe/Size	Länge/Length
3031	T10	300 mm
3032	T15	300 mm
3033	T20	300 mm
3034	T25	300 mm
3035	T30	300 mm
3036	T40	300 mm

**1/4" Schraubendreher-Einsätze
für Innensechskant-Schrauben**

Hex Bits



Art.-Nr./Art.-No.	Größe/Size	Länge/Length
3041	3,0 mm	300 mm
3042	4,0 mm	300 mm
3043	5,0 mm	300 mm
3044	6,0 mm	300 mm
3045	7,0 mm	300 mm
3046	8,0 mm	300 mm
3093	5/32"	300 mm
3094	9/64"	300 mm
3095	1/8"	300 mm
3096	7/64"	300 mm
3097	3/32"	300 mm
3098	5/64"	300 mm

Bit-Display / Magazin

Bit Display / Storage

**Fragen Sie nach unseren Bestückungen –
das Display kann auch individuell nach
Kundenwunsch bestückt werden!**Please ask for different contents –
the display content can be individualised due to your needs!**Art.-Gruppe 131**
Article Group 131**11911-01**

615 x 503 x 150 mm

Reihe 1/Line 1:

⊕ 25 mm	30 x PH1 - 50 x PH2 - 30 x PH3
⊕ 25 mm	TiN 20 x PH1 - 30 x PH2 - 20 x PH3
⊕ 50 mm	20 x PH2
⊕ 25 mm	10 x Schraubvorsatz mit Tiefenstopp PH 2
50 mm	Stecknuss Bit Adapter 1/4" x 1/4"

Reihe 2/Line 2:

⊕ 25 mm	30 x PZ1 - 50 x PZ2 - 30 x PZ3
⊕ 25 mm	TiN 20 x PZ1 - 30 x PZ2 - 20 x PZ3
⊕ 50 mm	10 x PZ1 - 20 x PZ2 - 10 x PZ3

Reihe 3/Line 3:

⊕ 25 mm	20 x TX10 - 20 x TX15 - 50 x TX20 - 50 x TX 25 - 50 x TX30 - 20 x TX 40
⊕ 25 mm	TiN 30 x TX15 - 30 x TX 20 - 30 x TX 25

Reihe 4/Line 4:

○ 65 mm	Stecknuss Bit 6 x 8 mm - 6 x 10 mm - 5 x 13 mm
	10 x Bit Magnethalter
	10 x Magnethalter mit Schnellspannfutter
	10 x Magnethalter mit „Ring-Magnet“

Art.-Nr./Art.-No.**tlg./pcs.**

11911-01

787

bestückt mit 787 Bits / with 787 Bits

1/4" Color-BIT-Schraubendreher Einsätze 25 + 75 mm

1/4" Color-Bits 25 + 75 mm



Art.-Gruppe 132
Article Group 132



1/4" Color-BIT-Schraubendreher-Einsätze, für Kreuzschlitz-Schrauben Phillips, 3er-Pack

Phillips Color-Bits, 3 pcs Box



Art.-Nr./Art.-No.	Größe/Size	Länge/Length
1701-03	PH 1	25 mm
1702-03	PH 2	25 mm
1703-03	PH 3	25 mm

1801-03	PH 1	75 mm
1802-03	PH 2	75 mm
1803-03	PH 3	75 mm

1/4" Color-BIT-Schraubendreher-Einsätze, für Kreuzschlitz-Schrauben Phillips, 10er-Pack

Phillips Color-Bits, 10 pcs Box



Art.-Nr./Art.-No.	Größe/Size	Länge/Length
1701-10	PH 1	25 mm
1702-10	PH 2	25 mm
1703-10	PH 3	25 mm

1/4" Color-BIT-Schraubendreher-Einsätze, für Kreuzschlitz-Schrauben Phillips, 50er Pack

Phillips Color-Bits, 50 pcs Box



Art.-Nr./Art.-No.	Größe/Size	Länge/Length
1701-50	PH 1	25 mm
1702-50	PH 2	25 mm

1/4" Color-BIT-Schraubendreher-Einsätze, für Schlitz-Schrauben, 3er-Pack

Slotted Color-Bits, 3 pcs Box



Art.-Nr./Art.-No.	Größe/Size	Länge/Length
1721-03	3 mm	25 mm
1722-03	4 mm	25 mm
1723-03	5 mm	25 mm
1724-03	6 mm	25 mm

1822-03	4 mm	75 mm
1824-03	6 mm	75 mm

1/4" Color-BIT-Schraubendreher-Einsätze, für Pozidriv-Schrauben Pozidriv, 3er-Pack

Pozidriv Color-Bits, 3 pcs Box



Art.-Nr./Art.-No.	Größe/Size	Länge/Length
1711-03	PZ 1	25 mm
1712-03	PZ 2	25 mm
1713-03	PZ 3	25 mm

1811-03	PZ 1	75 mm
1812-03	PZ 2	75 mm
1813-03	PZ 3	75 mm

1/4" Color-BIT-Schraubendreher-Einsätze, für Pozidriv-Schrauben Pozidriv, 10er-Pack

Pozidriv Color-Bits, 10 pcs Box



Art.-Nr./Art.-No.	Größe/Size	Länge/Length
1711-10	PZ 1	25 mm
1712-10	PZ 2	25 mm
1713-10	PZ 3	25 mm

1/4" Color-BIT-Schraubendreher-Einsätze, für Pozidriv-Schrauben Pozidriv, 50er-Pack

Pozidriv Color-Bits, 50 pcs Box



Art.-Nr./Art.-No.	Größe/Size	Länge/Length
1711-50	PZ 1	25 mm
1712-50	PZ 2	25 mm



Bits 25 mm
10er-Pack/10 pcs Box

Bits 25 mm
50er-Pack/50 pcs Box

1/4" Color-BIT-Schraubendreher Einsätze 25 + 75 mm

1/4" Color-Bits 25 + 75 mm



Art.-Gruppe 132
Article Group 132



Bits 25 mm
3er-Pack /
3 pcs Box



Bits 25 mm
10er-Pack /
10 pcs Box



Bits 25 mm
50er-Pack /
50 pcs Box



Bits 75 mm
3er-Pack /
3 pcs Box



1/4" Color-BIT-Schraubendreher-Einsätze, für TX-Schrauben TORX®, 3er-Pack

TORX® Color-Bits, 3 pcs Box



Art.-Nr./Art.-No.	Größe/Size	Länge/Length
1731-03	TX 10	25 mm
1732-03	TX 15	25 mm
1733-03	TX 20	25 mm
1734-03	TX 25	25 mm
1735-03	TX 27	25 mm
1736-03	TX 30	25 mm
1737-03	TX 40	25 mm

1831-03	TX 10	75 mm
1832-03	TX 15	75 mm
1833-03	TX 20	75 mm
1834-03	TX 25	75 mm
1835-03	TX 27	75 mm
1836-03	TX 30	75 mm
1837-03	TX 40	75 mm

1/4" Color-BIT-Schraubendreher-Einsätze, für TX-Schrauben TORX®, 10er-Pack

TORX® Color-Bits, 10 pcs Box



Art.-Nr./Art.-No.	Größe/Size	Länge/Length
1731-10	TX 10	25 mm
1732-10	TX 15	25 mm
1733-10	TX 20	25 mm
1734-10	TX 25	25 mm
1735-10	TX 27	25 mm
1736-10	TX 30	25 mm
1737-10	TX 40	25 mm

1/4" Color-BIT-Schraubendreher-Einsätze, für TX-Schrauben TORX®, 50er-Pack

TORX® Color-Bits, 50 pcs Box



Art.-Nr./Art.-No.	Größe/Size	Länge/Length
1731-50	TX 10	25 mm
1732-50	TX 15	25 mm
1733-50	TX 20	25 mm
1734-50	TX 25	25 mm
1736-50	TX 30	25 mm

1/4" Color-BIT-Schraubendreher-Einsätze, für TX-Schrauben mit Bohrung TAMPER TORX®, 3er-Pack

Tamper TORX® Color-Bits, 3 pcs Box



Art.-Nr./Art.-No.	Größe/Size	Länge/Length
1751-03	Tamper TX 10	25 mm
1752-03	Tamper TX 15	25 mm
1753-03	Tamper TX 20	25 mm
1754-03	Tamper TX 25	25 mm
1755-03	Tamper TX 27	25 mm
1756-03	Tamper TX 30	25 mm
1757-03	Tamper TX 40	25 mm

1/4" Color-BIT-Schraubendreher-Einsätze, für Sechskant-Schrauben, Inbus, 3er-Pack

Hex Color-Bits, 3 pcs Box



Art.-Nr./Art.-No.	Größe/Size	Länge/Length
1741-03	Hex 3	25 mm
1742-03	Hex 4	25 mm
1743-03	Hex 5	25 mm
1744-03	Hex 6	25 mm
1841-03	Hex 3	75 mm
1842-03	Hex 4	75 mm
1843-03	Hex 5	75 mm

1/4" Color-BIT-Schraubendreher-Einsätze, für Sechskant-Schrauben, Inbus, 10er-Pack

Hex Color-Bits, 10 pcs Box



Art.-Nr./Art.-No.	Größe/Size	Länge/Length
1742-10	Hex 4	25 mm
1743-10	Hex 5	25 mm



Bits 25 mm
10er-Pack/10 pcs Box

Bits 25 mm
50er-Pack/50 pcs Box

1/4" BIT-Schraubendreher-Einsätze, diamantbeschichtet

1/4" Bits, Diamond Coating

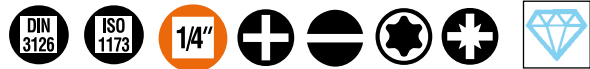

Art.-Gruppe 130
Article Group 130

1/4" BIT-Schraubendreher-Einsätze, diamantbeschichtet für Kreuzschlitz-Schrauben Phillips, 3er-Pack

Phillips Bits, Diamond Coating, 3 pcs Box



Art.-Nr./Art.-No.	Größe/Size	Länge/Length
1750001-03	PH 1	25 mm
1750002-03	PH 2	25 mm
1750003-03	PH 3	25 mm
1751001-03	PH 1	50 mm
1751002-03	PH 2	50 mm
1751003-03	PH 3	50 mm

1/4" BIT-Schraubendreher-Einsätze, diamantbeschichtet für Schlitz-Schrauben, 3er-Pack

Slotted Bits, Diamond Coating, 3 pcs Box



Art.-Nr./Art.-No.	Größe/Size	Länge/Length
1750202-03	4,0 mm	25 mm
1750203-03	4,5 mm	25 mm
1750204-03	5,5 mm	25 mm
1751202-03	4,0 mm	50 mm
1751203-03	4,5 mm	50 mm
1751204-03	5,5 mm	50 mm

1/4" BIT-Schraubendreher-Einsätze, diamantbeschichtet für Innen-TX-Schrauben, 3er-Pack

TX Bits, Diamond Coating, 3 pcs Box



Art.-Nr./Art.-No.	Größe/Size	Länge/Length
1750310-03	T10	25 mm
1750315-03	T15	25 mm
1750320-03	T20	25 mm
1750325-03	T25	25 mm
1750330-03	T30	25 mm
1751310-03	T10	50 mm
1751315-03	T15	50 mm
1751320-03	T20	50 mm
1751325-03	T25	50 mm
1751330-03	T30	50 mm

1/4" BIT-Schraubendreher-Einsätze, diamantbeschichtet für Kreuzschlitz-Schrauben Pozidriv, 3er-Pack

Pozidriv Bits, Diamond Coating, 3 pcs Box



Art.-Nr./Art.-No.	Größe/Size	Länge/Length
1750101-03	PZ 1	25 mm
1750102-03	PZ 2	25 mm
1750103-03	PZ 3	25 mm
1751101-03	PZ 1	50 mm
1751102-03	PZ 2	50 mm
1751103-03	PZ 3	50 mm

Diamantbeschichtete Bit-Schraubendreher-Einsätze

Diamond Coated Bits

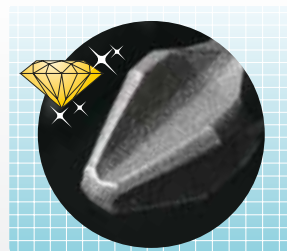

- ▶ Mit Diamantpartikeln besetzte Antriebsspitze minimiert das Herausrutschen des Bits aus der Schraube
 - ▶ Sicheres Verschrauben auf empfindlichen Oberflächen
 - ▶ Sauberes Verschraubungsergebnis und weniger Verschleiß
 - ▶ Kürzere Verschraubungszeiten
 - ▶ Leicht erkennbar durch weißen Farbring
 - ▶ Ergonomischeres Arbeiten durch Reduzierung des Anpressdruckes
 - ▶ Zusätzliche Torsionszone leitet Kraftspitzen in den Bit ab – reduziert Schäden am Bit
-
- ▶ Diamond coated bit tip minimize the "Cam-out-effect"
 - ▶ Safer screw driving on sensitive surfaces
 - ▶ Less fatiguing work due to the reducing of contact pressure
 - ▶ High class work result
 - ▶ Less wear at the tool and screw
 - ▶ Quicker fastening time
 - ▶ Torsion twist zone reduces bit breakage
 - ▶ Easily recognizable with their white color ring

1/4" TORSION BIT-Schraubendreher Einsätze

1/4" TORSION Bits

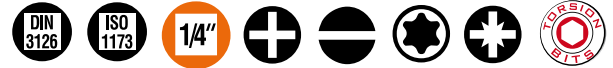

Art.-Gruppe 130
Article Group 130

1/4" TORSION BIT-Schraubendreher-Einsätze für Kreuzschlitz-Schrauben Phillips, mit ACR II – Profil, 3er Pack

Phillips TORSION Bits, ACR II - Profile, 3 pcs Box



Art.-Nr./Art.-No.	Größe/Size	Länge/Length
176001-03	PH 1	25 mm
176002-03	PH 2	25 mm
176003-03	PH 3	25 mm
176101-03	PH 1	50 mm
176102-03	PH 2	50 mm
176103-03	PH 3	50 mm

1/4" TORSION BIT-Schraubendreher-Einsätze für Schlitz-Schrauben, 3er Pack

Slotted TORSION Bits, 3 pcs Box



Art.-Nr./Art.-No.	Größe/Size	Länge/Length
176020-03	4,0 mm	25 mm
1760203-03	4,5 mm	25 mm
1760205-03	5,5 mm	25 mm
176120-03	4,0 mm	50 mm
1761203-03	4,5 mm	50 mm
1761205-03	5,5 mm	50 mm

1/4" TORSION BIT-Schraubendreher-Einsätze für Innen-TX-Schrauben, 3er Box

TX TORSION Bits, 3 pcs Box



Art.-Nr./Art.-No.	Größe/Size	Länge/Length
1760310-03	T10	25 mm
1760315-03	T15	25 mm
1760320-03	T20	25 mm
1760325-03	T25	25 mm
1760330-03	T30	25 mm
1760340-03	T40	25 mm
1761310-03	T10	50 mm
1761315-03	T15	50 mm
1761320-03	T20	50 mm
1761325-03	T25	50 mm
1761330-03	T30	50 mm
1761340-03	T40	50 mm

1/4" TORSION BIT-Schraubendreher-Einsätze für Kreuzschlitz-schrauben Pozidriv, mit ACR II – Profil, 3er Pack

Pozidriv TORSION Bits, ACR II - Profile, 3 pcs Box



Art.-Nr./Art.-No.	Größe/Size	Länge/Length
1760101-03	PZ 1	25 mm
1760102-03	PZ 2	25 mm
1760103-03	PZ 3	25 mm
1761101-03	PZ 1	50 mm
1761102-03	PZ 2	50 mm
1761103-03	PZ 3	50 mm

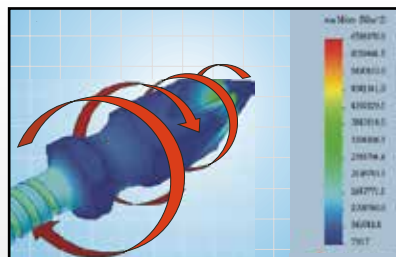

PROJAHN TORSION-Bit

Kräfte werden in den Bit abgeleitet / Forces will disperse at torsion zone

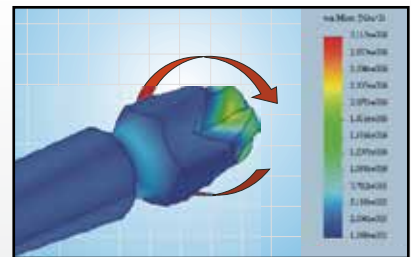

Standard-Bit

Kräfte werden an der Spitze zentriert / Forces will accumulated at the tip of bit

- ▶ Für höchste Belastung ausgelegt
- ▶ Ideal für Schlagschrauber geeignet
- ▶ Spezielle Torsionszone leitet die Belastung der Bohrspitze in den Bit ab
- ▶ Wesentlich längere Standzeit und geringere Bruchgefahr
- ▶ Reduzierung des Herausrutschens des Bits durch zusätzliche ACR-Profile

- ▶ Produced of high-performance Steel – Designed for maximum forces
- ▶ Especially suitable for use with impact drivers
- ▶ Special designed torsion zone absorbs forces into the bit
- ▶ Longer durability and less breakage
- ▶ Additional with Cam-out-rips

5/16" BIT- Schraubendreher Einsätze

5/16" Bits



Art.-Gruppe 130
Article Group 130

5/16" BIT-Schraubendreher-Einsätze für Kreuzschlitz-Schrauben Phillips

Phillips Bits



Art.-Nr./Art.-No.	Größe/Size	Länge/Length
303001	PH 1	30 mm
303002	PH 2	30 mm
303003	PH 3	30 mm
303004	PH 4	30 mm
313001	PH 1	70 mm
313002	PH 2	70 mm
313003	PH 3	70 mm

5/16" BIT-Schraubendreher-Einsätze für Schlitz-Schrauben

Slotted Bits



Art.-Nr./Art.-No.	Größe/Size	Länge/Length
302055	5,5 x 0,8 mm	30 mm
302065	6,5 x 1,0 mm	30 mm
302080	8,0 x 1,2 mm	30 mm
302100	10,0 x 1,6 mm	30 mm
302120	12,0 x 2,0 mm	30 mm

5/16" BIT-Schraubendreher-Einsätze für Innen-TX-Schrauben

TX Bits



Art.-Nr./Art.-No.	Größe/Size	Länge/Length
305010	T10	30 mm
305015	T15	30 mm
305020	T20	30 mm
305025	T25	30 mm
305027	T27	30 mm
305030	T30	30 mm
305040	T40	30 mm
305045	T45	30 mm
305050	T50	30 mm
305055	T55	30 mm
305060	T60	30 mm
305070	T70	30 mm
315015	T15	70 mm
315020	T20	70 mm
315025	T25	70 mm
315027	T27	70 mm
315030	T30	70 mm
315040	T40	70 mm
315045	T45	70 mm
315050	T50	70 mm
315055	T55	70 mm
315060	T60	70 mm

5/16" BIT-Schraubendreher-Einsätze für Innen-TX-Schrauben mit stirnseitiger Bohrung

Tamper TX Bits



Art.-Nr./Art.-No.	Größe/Size	Länge/Length
305310	T10	30 mm
305315	T15	30 mm
305320	T20	30 mm
305325	T25	30 mm
305327	T27	30 mm
305330	T30	30 mm
305340	T40	30 mm
305345	T45	30 mm
305350	T50	30 mm
305355	T55	30 mm
305360	T60	30 mm
305370	T70	30 mm

5/16" BIT-Schraubendreher-Einsätze für Innensechskant-Schrauben

Hex Bits



Art.-Nr./Art.-No.	Größe/Size	Länge/Length
306004	4 mm	30 mm
306005K	5 mm	30 mm
306006	6 mm	30 mm
306007	7 mm	30 mm
306008	8 mm	30 mm
306010	10 mm	30 mm
306012	12 mm	30 mm
306014	14 mm	30 mm
316004	4 mm	70 mm
316005	5 mm	70 mm
316006	6 mm	70 mm
316008	8 mm	70 mm

5/16" BIT-Schraubendreher-Einsätze für Kreuzschlitz-Schrauben Pozidriv

Pozidriv Bits



Art.-Nr./Art.-No.	Größe/Size	Länge/Length
304001	PZ 1	30 mm
304002	PZ 2	30 mm
304003	PZ 3	30 mm
304004	PZ 4	30 mm
314001	PZ 1	70 mm
314002	PZ 2	70 mm

10 mm BIT- Schraubendreher Einsätze

10 mm Bits

**Art.-Gruppe 130**
Article Group 130**10 mm BIT-Schraubendreher-Einsätze für Vielzahn-Schrauben**

10 mm Spline Impact Bits



Art.-Nr./Art.-No.	Größe/Size	Länge/Length
348605	M5	30 mm
348606	M6	30 mm
348608	M8	30 mm
348610	M10	30 mm
348612	M12	30 mm
348614	M14	30 mm
<hr/>		
348705	M5	75 mm
348706	M6	75 mm
348708	M8	75 mm
348710	M10	75 mm
348712	M12	75 mm
348714	M14	75 mm

10 mm Schraubendreher-Einsätze für Innensechskant-Schrauben

10 mm Hex Bits



Art.-Nr./Art.-No.	Größe/Size	Länge/Length
306040	4 mm	30 mm
306050	5 mm	30 mm
306060	6 mm	30 mm
306080	8 mm	30 mm
306100	10 mm	30 mm
306120	12 mm	30 mm

10 mm Bit Ratsche umschaltbar

10 mm Bit Ratchet reversible



Art.-Nr./Art.-No.	Größe/Size	Länge/Length
4295	10 mm	138 mm

10 mm BIT-Schraubendreher-Einsätze für Innen-TX-Schrauben

10 mm TX Impact Bits



Art.-Nr./Art.-No.	Größe/Size	Länge/Length
305620	T20	30 mm
305625	T25	30 mm
305627	T27	30 mm
305630	T30	30 mm
305640	T40	30 mm
305645	T45	30 mm
305650	T50	30 mm
305655	T55	30 mm
305660	T60	30 mm
305670	T70	30 mm

315620	T20	75 mm
315625	T25	75 mm
315627	T27	75 mm
315630	T30	75 mm
315640	T40	75 mm
315645	T45	75 mm
315650	T50	75 mm
315655	T55	75 mm
315660	T60	75 mm
315670	T70	75 mm

10 mm BIT-Schraubendreher-Einsätze für Innen-TX-Schrauben mit stirnseitiger Bohrung

10 mm Tamper TX Impact Bits



Art.-Nr./Art.-No.	Größe/Size	Länge/Length
305720	T20	30 mm
305725	T25	30 mm
305727	T27	30 mm
305730	T30	30 mm
305740	T40	30 mm
305745	T45	30 mm
305750	T50	30 mm
305755	T55	30 mm
305760	T60	30 mm
305770	T70	30 mm

315720	T20	75 mm
315725	T25	75 mm
315727	T27	75 mm
315730	T30	75 mm
315740	T40	75 mm
315745	T45	75 mm
315750	T50	75 mm
315755	T55	75 mm
315760	T60	75 mm
315770	T70	75 mm

1/4" Spezial- und Sonder-BIT- Schraubendreher Einsätze

1/4" Special And Security Bits



Art.-Gruppe 130
Article Group 130

1/4" Schraubendreher-Einsätze Robertson für SpanoElecPlus-Schrauben

Robertson Bits



Art.-Nr./Art.-No.	Größe/Size	Länge/Length
2651	R1/2,5 mm	25 mm
2652	R2/3,0 mm	25 mm
2653	R3/3,5 mm	25 mm
2656	R1/2,5 mm	50 mm
2657	R2/3,0 mm	50 mm
2658	R3/3,5 mm	50 mm

1/4" Schraubendreher-Einsätze für Spanner-Schrauben

Spanner Bits

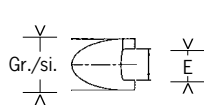

Art.-Nr./Art.-No.	Größe/Size	Länge/Le.	E
2665	4 mm	25 mm	1,52
2667	6 mm	25 mm	2,41
2668	8 mm	25 mm	3,00
2669	10 mm	25 mm	3,60
2691	12 mm	25 mm	3,81
2692	14 mm	25 mm	5,00

1/4" Schraubendreher-Einsätze für Clutch Schrauben

Clutch Bits



Art.-Nr./Art.-No.	Größe/Size	Länge/Length
3181	3/32	25 mm
3182	1/8	25 mm
3183	5/32	25 mm
3184	3/16	25 mm
3185	1/4	25 mm

1/4" Schraubendreher-Einsätze für Torq-Schrauben

Torq Bits



Art.-Nr./Art.-No.	Größe/Size	Länge/Length
2661	6 mm	25 mm
2662	8 mm	25 mm
2663	10 mm	25 mm

1/4" Eindreh-Bit für Haken

Hook Driver



Art.-Nr./Art.-No. Größe/Size

2690	1/4"
------	------

1/4" Schraubendreher-Einsätze für Vielzahn Schrauben

Spline Bits



Art.-Nr./Art.-No.	Größe/Size	Länge/Length
3161	M4	25 mm
3162	M5	25 mm
3163	M6	25 mm
3164	M8	25 mm
3165	M10	25 mm

1/4" Schraubendreher-Einsätze für Tri-Wing-Schrauben

Tri-Wing Bits



Art.-Nr./Art.-No.	Größe/Size	Länge/Length
2671	Nr. 1	25 mm
2672	Nr. 2	25 mm
2673	Nr. 3	25 mm
2674	Nr. 4	25 mm

1/4" Schraubendreher-Einsätze für Assy®-Schrauben/SIT®-Bits

SIT® Bits

Spezial-Profil



Art.-Nr./Art.-No.	Größe/Size	Länge/Length
2890	PW10	25 mm
2891	PW15	25 mm
2892	PW20	25 mm
2893	PW25	25 mm
2894	PW30	25 mm
2895	PW40	25 mm

SIT® und Assy® sind eingetragene Warenzeichen der Adolf Würth GmbH / SIT® and Assy® are registered trade marks of company Adolf Würth GmbH

1/4" Schraubendreher-Einsätze für Keilzahn Schrauben

Ribe Bits



Art.-Nr./Art.-No.	Größe/Size	Länge/Length
3171	M4	25 mm
3172	M5	25 mm
3173	M6	25 mm
3174	M7	25 mm
3175	M8	25 mm

1/4" BIT-Stecknüsse, -Adapter, -Halter

1/4" Bits



Art.-Gruppe 130
Article Group 130

PROFESSIONAL PLUS STANDARD

Stecknuss Bit mit Dauermagnet

Magnetic Nut Setter



Art.-Nr./Art.-No.	Größe/Size	Länge/Length
3783-06	6 mm	45 mm
3783-07	7 mm	45 mm
3783-08	8 mm	45 mm
3783-10	10 mm	45 mm
3783-11	11 mm	45 mm
3783-12	12 mm	45 mm
3783-13	13 mm	45 mm

3784-55	5,5 mm	65 mm
3784-06	6 mm	65 mm
3784-07	7 mm	65 mm
3784-08	8 mm	65 mm
3784-10	10 mm	65 mm
3784-11	11 mm	65 mm
3784-12	12 mm	65 mm
3784-13	13 mm	65 mm
3784-15	15 mm	65 mm
3784-16	16 mm	65 mm
3784-17	17 mm	65 mm
3784-1/4	1/4"	65 mm
3784-5/16	5/16"	65 mm
3784-3/8	3/8"	65 mm

Sortimente auf Seite / Sets on Page
H 184

PROFESSIONAL PLUS STANDARD

Stecknuss Bit für Edelstahlschrauben mit Haltefeder

Nut Setter With Spring For Stainless Screws



Art.-Nr./Art.-No.	Größe/Size	Länge/Length
3785-08	8 mm	45 mm
3785-10	10 mm	45 mm
3785-1/4	1/4"	45 mm
3785-5/16	5/16"	45 mm
3785-3/8	3/8"	45 mm

PROFESSIONAL PLUS STANDARD

Eindrehwerkzeuge für Stockschrauben mit Innengewinde

Screw Tight Tool for Setting Screws



Art.-Nr./Art.-No.	Größe/Size
3784-M6	M 6
3784-M8	M 8
3784-M10	M10
3784-M12	M12

PROFESSIONAL PLUS STANDARD

1/4" Stecknuss Bit Adapter für Nüsse

Bit Adapter For Sockets



Art.-Nr./Art.-No.	Größe/Size	Länge/Length
2770	1/4" x 1/4"	25 mm
2850	1/4" x 1/4"	50 mm
2862	1/4" x 1/4"	100 mm
2860	1/4" x 3/8"	50 mm
2864	1/4" x 3/8"	100 mm
2870	1/4" x 1/2"	50 mm

PROFESSIONAL PLUS STANDARD

1/4" Stecknuss Bit Adapter Satz, 3-tlg. 50 mm für Stecknüsse 1/4", 3/8", 1/2"

Bit Adapter Set, 3 pieces 50 mm For Sockets 1/4", 3/8", 1/2"

3
tlg./pcs.



Art.-Nr./Art.-No.	Größe/Size	Länge/Length
2880	1/4" x 1/4"	50 mm
	1/4" x 3/8"	50 mm
	1/4" x 1/2"	50 mm

PROFESSIONAL PLUS STANDARD

Bit Halter

Bit Holder



Art.-Nr./Art.-No.	Größe/Size
2769	1/4" Bit-Halter mit SDS-Aufnahme bit holder with quick release – SDS-shank

PROFESSIONAL PLUS STANDARD

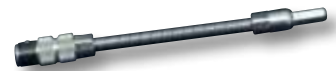

Art.-Nr./Art.-No.	Länge/Length
107140	Verlängerung flexibel 135 mm flexible extension bar 135 mm

PROFESSIONAL PLUS STANDARD



Art.-Nr./Art.-No.	Länge/Length
2750	1/4" Universal 60 mm magnetic bit holder 60 mm

PROFESSIONAL PLUS STANDARD



Art.-Nr./Art.-No.	Länge/Length
2764	1/4" Universal 142 mm magnetic bit holder 142 mm

PROFESSIONAL PLUS STANDARD

Bit Adapter

Bit Adapter



Art.-Nr./Art.-No.	Größe/Size
2760	1/4" Adapter für 1/4" Bits
2761	3/8" Adapter für 1/4" Bits
311516	1/2" Adapter für 5/16" Bits
381214	1/2" Schlag-Adapter für 1/4" Bits

1/4" BIT-Halter- und Antriebswerkzeuge

1/4" Bits



Art.-Gruppen 120/130/132/140
Article Groups 120/130/132/140

PROFESSIONAL PLUS STANDARD

1/4" Mini Bit Ratsche umschaltbar
1/4" Mini Bit Ratchet reversible



Art.-Nr./Art.-No.	Größe/Size	Länge/Length
4294	1/4"	103 mm

Dual Umschaltknarre für Bits + Nüsse
Dual Ratchet Handle For Bits + Sockets



Art.-Nr./Art.-No.	Größe/Size	Länge/Length
4290	1/4"	105 mm

10 mm Bit Ratsche umschaltbar
10 mm Bit Ratchet reversible



Art.-Nr./Art.-No.	Größe/Size	Länge/Length
4295*	10 mm	138 mm

*Lieferung nur solange der Vorrat reicht / Delivery while stocks last

PROFESSIONAL PLUS STANDARD

1/4" XS Mini-Bit-Knarre, umschaltbar
1/4" Mini Ratchet Handle, Reversible

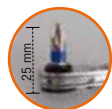

Art.-Nr./Art.-No.	Größe/Size	Länge/Length
4288	1/4"	86 mm

PROFESSIONAL PLUS STANDARD

Magnetische Bit Schraubendreher für Handbetrieb 1/4"
Bit Screwdriver



Art.-Nr./Art.-No.	Größe/Size
2128	1/4" Universal, schwarzer Griff Magnetic Bit Screwdriver, Black Handle



Art.-Nr./Art.-No.	Größe/Size
4190-01	1/4" Universal Magnetic Bit Screwdriver



Art.-Nr./Art.-No.	Größe/Size
4690-02	1/4" mit Schnellspannfutter Quick Release Bit Screwdriver



Art.-Nr./Art.-No.	Größe/Size
4190-03	1/4" kurz mit Schnellspannfutter Quick Release Bit Screwdriver, Short Version

PROFESSIONAL PLUS STANDARD

Bit Halter
Bit Holder

NEU/NEW



Art.-Nr./Art.-No.	Größe/Size	Länge/Length
2768	1/4" TORSION mit Schnellspannfutter TORSION With Quick Release	65 mm



Art.-Nr./Art.-No.	Größe/Size	Länge/Length
2765	1/4" mit Schnellspannfutter Bit Holder With Quick Release	60 mm



Art.-Nr./Art.-No.	Größe/Size	Länge/Length
2766	1/4" mit Schnellspannfutter Bit Holder With Quick Release	152 mm



Art.-Nr./Art.-No.	Größe/Size
2767	1/4" mit Schnellspannfutter Bit Holder With Quick Release

PROFESSIONAL PLUS STANDARD

1/4" Bit Halter mit Tiefeneinstellung
1/4" Bit Holder with Depth Adjustment



Art.-Nr./Art.-No.	Größe/Size
3750	1/4" mit „Ring-Magnet“ und Tiefeneinstellung/ Magnetic Bit Holder with Screw-Cap and Depth Adjustment

1/4" BIT-Sätze

1/4" Bit Sets

1/4"

Art.-Gruppe 131
Article Group 131

394074 PROFESSIONAL PLUS STANDARD

1/4" KOMBI BIT Box

Bit Set

1/4"

31
tlg./pcs.



3	☉	Schlitz/Slotted	4 - 5.5 - 6.5 mm
5	⊕	Phillips/PH	PH 1 - PH 1 - PH 2 - PH 2 - PH 3
5	⊕	Pozidriv/PZ	PZ 1 - PZ 1 - PZ 2 - PZ 2 - PZ 3
9	⊗	TORX®/TX	T8 - 9 - 10 - 15 - 20 - 25 - 27 - 30 - 40
8	⊙	Inbus/Hex	2 - 2,5 - 3 - 4 - 5 - 6 - 7 - 8 mm
1		Magnethalter mit Schnellspannfutter, 60 mm	

Art.-Nr./Art.-No.	G/S	tlg./pcs.	B	L	H
394074	1/4"	31	105	65	41
39407412	1/4"	12 x 31	323	277	72
Display mit 12 Boxen 394074					

394075 PROFESSIONAL PLUS STANDARD

1/4" KOMBI BIT Box

Bit Set

1/4"

31
tlg./pcs.



3	☉	Schlitz/Slotted	4 - 5.5 - 6.5 mm
5	⊕	Phillips/PH	PH 1 - PH 1 - PH 2 - PH 2 - PH 3
5	⊕	Pozidriv/PZ	PZ 1 - PZ 1 - PZ 2 - PZ 2 - PZ 3
9	⊗	TORX® mit Bohrung/TX	T8 - 9 - 10 - 15 - 20 -
		Tamper TX	25 - 27 - 30
8	⊙	Inbus/Hex	2 - 2,5 - 3 - 4 - 5 - 6 - 7 - 8 mm
1		Magnethalter mit Schnellspannfutter, 60 mm	

Art.-Nr./Art.-No.	G/S	tlg./pcs.	B	L	H
394075	1/4"	31	105	65	41
39407512	1/4"	12 x 31	323	277	72
Display mit 12 Boxen 394075					

4085 PROFESSIONAL PLUS STANDARD

1/4" Allround-Bit Box, 22-teilig

Allround-Bit Set, 22 pieces

1/4"

22
tlg./pcs.



3	☉	Schlitz/Slotted	4,5 - 5,5 - 6,5 mm
2	⊕	Phillips/PH	PH 1 - PH 2
3	⊕	Pozidriv/PZ	PZ 1 - PZ 2 - PZ 3
8	⊗	TORX®/TX	T8 - 10 - 15 - 20 - 25 - 27 - 30 - 40
4	⊙	Stecknuss Bit	7 - 8 - 10 - 11 mm
1		Magnethalter	
1		Bit Adapter	1/4" x 1/4"

Art.-Nr./Art.-No.	G./S.	tlg./pcs.	B	L	H
4085	1/4"	22	115	95	32

Bits aus S2-Stahl

Größe/Size: 1/4" · tlg./pcs.: 22 · BxLxH/WxLxH: 115x95x32 mm
Gewicht/Weight: 280 g

1/4" + 5/16" BIT-Sätze

1/4" + 5/16" Bit Sets



Art.-Gruppe 131
Article Group 131

4092

PROFESSIONAL PLUS STANDARD

1/4" + 5/16" Kombi-Bit-Box, inkl. GearTech Doppelringschlüssel

1/4" + 5/16" Combi Bit Set,

incl. GearTech Bit Double Ring Wrench

1/4"

5/16"

32
tlg./pcs.



3914516

PROFESSIONAL PLUS STANDARD

1/4" + 5/16" GearTech Bit-Doppelringschlüssel

1/4" + 5/16" GearTech Bit Double Ring Wrench

GearTech



Umschaltbar, ergonomisch gebogen/reversible, ergonomically curved

3	☉	Schlitz/Slotted	4 - 5,5 - 6,5 mm	1/4"
2	⊕	Phillips/PH	PH 1 - PH 2	
2	⊕	Pozidriv/PZ	PZ 1 - PZ 2	
6	⊗	TORX®/TX	TX8 - 10 - 15 - 20 - 25 - 27	
4	⊙	Inbus/Hex	3 - 4 - 5 - 6 mm	
2	☉	Schlitz/Slotted	8 - 10 mm	5/16"
2	⊕	Phillips/PH	PH 3 - PH 4	
2	⊕	Pozidriv/PZ	PZ 3 - PZ 4	
6	⊗	TORX®/TX	TX30 - 40 - 45 - 50 - 55 - 60	
2	⊙	Inbus/Hex	7 - 8 mm	
1		GearTech Doppelringschlüssel 1/4" + 5/16"		

Art.-Nr./Art.-No.	G./S.	tlg./pcs.	B	L	H
4092	1/4" + 5/16"	32	135	85	33
3914516	1/4" + 5/16"	GearTech Doppelringschlüssel (125 mm)			

4193

PROFESSIONAL PLUS STANDARD

1/4" Stubby- Ratschenschraubendreher

1/4" Stubby Ratchet Screw Driver

1/4"

8
tlg./pcs.



235 x 185 x 120 mm
Höhe geöffnet/height open: 265 mm
Art. 419312

Display mit /with 12x 4193

Art.-Nr./Art.-No.	G./S.	tlg./pcs	B	L	H
4193	1/4"	8	95 mm	38 mm	38 mm
419312	1/4"	12 x 8	235 mm	185 mm	120 mm

Display mit 12 x 4193

1	☉	Schlitz/Slotted	5,5 mm
2	⊕	Phillips/PH	PH 1 - 2
2	⊕	Pozidriv/PZ	PZ 1 - 2
2	⊗	TORX®/TX	T20 - 25
1		Stubby-Ratschenschraubendreher	

1/4" BIT-Sätze

1/4" Bit Sets



Art.-Gruppe 131
Article Group 131

394089 PROFESSIONAL PLUS STANDARD

1/4" Color-Bit-Box, 32-teilig

1/4" Color Bit Set, 32 pieces



32
tlg./pcs.



394087 PROFESSIONAL PLUS STANDARD

NEU/NEW

1/4" TORSION Color-Bit-Box, 32-teilig

1/4" TORSION Color Bit Set, 32 pieces



32
tlg./pcs.



- 2 Schlitz/Slotted (rot/red) 4 - 5 mm
- 4 Phillips/PH (dunkelrot/dark red) PH 1 - 2 - 2 - 3
- 4 Pozidriv/PZ (blau/blue) PZ 1 - 2 - 2 - 3
- 7 TORX®/TX (gelb/yellow) TX10-15-20-25-27-30-40
- 7 TORX® mit Bo./Tamper TX (violett) TX10-15-20-25-27-30-40
- 6 Inbus/Hex (orange) 2 - 2,5 - 3 - 4 - 5 - 6 mm
- 1 Stecknuss Bit Adapter 1/4" x 1/4", 25 mm
- 1 Magnethalter mit Schnellspannfutter, 60 mm

- 2 Schlitz/Slotted (rot/red) 4 - 5 mm
- 4 Phillips/PH (dunkelrot/dark red) PH 1 - 2 - 2 - 3
- 4 Pozidriv/PZ (blau/blue) PZ 1 - 2 - 2 - 3
- 7 TORX®/TX (gelb/yellow) TX10-15-20-25-27-30-40
- 7 TORX® mit Bo./Tamper TX (violett) TX10-15-20-25-27-30-40
- 6 Inbus/Hex (orange) 2 - 2,5 - 3 - 4 - 5 - 6 mm
- 1 Stecknuss Bit Adapter 1/4" x 1/4", 25 mm
- 1 Magnethalter mit Schnellspannfutter, 60 mm

Art.-Nr./Art.-No.	G./S.	tlg./pcs	B	L	H
394089	1/4"	32	95	65	40

39408912	1/4"	12 x 32	356	270	72
Display mit 12 Boxen 394089					

Art.-Nr./Art.-No.	G./S.	tlg./pcs	B	L	H
394087	1/4"	32	95	65	40

39408712	1/4"	12 x 32	356	270	72
Display mit 12 Boxen 394087					

Praktische Kunststoff-Kassette mit Klarsichtdeckel. Passt bequem in jede Werkzeugtasche. Farbige markierte Bits erleichtern das Suchen der richtigen Größe.

Convenient plastic cases with transparent top cover. Best for every kind of tool bag. Very easy to find the right size, because of colored bits.



356 x 270 x 72 mm
Höhe geöffnet/height open: 340 mm
Art. 39408912
Display mit /with 12x 394089

Praktische Kunststoff-Kassette mit Klarsichtdeckel. Passt bequem in jede Werkzeugtasche. Farbige markierte Bits erleichtern das Suchen der richtigen Größe.

Convenient plastic cases with transparent top cover. Best for every kind of tool bag. Very easy to find the right size, because of colored bits.



Bithalter auf Seite / Bit Holder on Page
H 172

356 x 270 x 72 mm
Höhe geöffnet/height open: 340 mm
Art. 39408712
Display mit /with 12x 394087

1/4" BIT-Sätze

1/4" Bit Sets



Art-Gruppe 132
Article Group 132

4091 PROFESSIONAL PLUS STANDARD

1/4" Color-Bit-Box, 15-teilig

1/4" Color Bit Set, 15 pieces



15
tlg./pcs.

Praktische Kunststoff-Kassette mit automatisch aufklappbarem Klarsichtdeckel. Passt bequem in jede Werkzeugtasche. Farblich markierte Bits erleichtern das Suchen der richtigen Größe.

Convenient plastic cases with automatically opening transparent lid.

Best for every kind of tool bag. Very easy to find the right size, because of colored bits.



4095 PROFESSIONAL PLUS STANDARD

1/4" Color-Bit-Box mit Mini-Bit-Knarre

Color Bit Set With Mini-Ratchet-Handle



33
tlg./pcs.



- 2 Schlitz/Slotted (rot/red) 4 - 6 mm
- 2 Phillips/PH (dunkelrot/dark red) PH 1 - PH 2
- 2 Pozidriv/PZ (blau/blue) PZ 1 - PZ 2
- 5 TORX®/TX (gelb/yellow) T10 - 15 - 20 - 25 - 30
- 3 Inbus/Hex (orange) 3 - 4 - 5 mm
- 1 Bit Magnethalter 60 mm

- 2 Schlitz/Slotted (rot/red) 4 - 5 mm
- 4 Phillips/PH (dunkelrot/dark red) PH 1 - 2 - 2 - 3
- 4 Pozidriv/PZ (blau/blue) PZ 1 - 2 - 2 - 3
- 6 Inbus (orange) 2 - 2,5 - 3 - 4 - 5 - 6 mm
- 7 TORX®/TX (gelb/yellow) T10 - 15 - 20 - 25 - 27 - 30 - 40
- 7 TORX® mit Bo./Tamper TX (violett) T10 - 15 - 20 - 25 - 27 - 30 - 40
- 1 Stecknuss Bit Adapter 25 mm
- 1 Bit Magnethalter 60 mm
- 1 XS Mini-Bit-Knarre (Art-Nr. 4288)

Art.-Nr./Art.-No.	G./S.	tlg./pcs	B	L	H
4091	1/4"	15	50	95	30

409124	1/4"	24 x 15	315	320	100
Display mit 24 Boxen 4091					

Art.-Nr./Art.-No.	G./S.	tlg./pcs	B	L	H
4095	1/4"	33	125	70	35

409512	1/4"	12 x 33	333	313	84
Display mit 12 Boxen 4095					

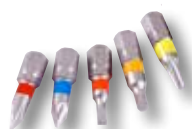

315 x 320 x 100 mm
Höhe geöffnet/height open: 320 mm
Art. 409124
Display mit /with 24x 4091



310 x 333 x 84 mm
Höhe geöffnet/height open: 307 mm
Art. 409512
Display mit /with 12x 4095

1/4" BIT-Sätze

1/4" Bit Sets



Art.-Gruppe 132
Article Group 132

4093 PROFESSIONAL PLUS STANDARD

1/4" Color-Bit-Box 75 mm, 18-teilig

Color Bit Set 75 mm, 18 pieces



18
tlg./pcs.



- 2 Schlitz/Slotted (rot/red) 4 - 6 mm
- 3 Phillips/PH (dunkelrot/dark red) PH 1 - 2 - 3
- 3 Pozidriv/PZ (blau/blue) PZ 1 - 2 - 3
- 3 Inbus (orange) 3 - 4 - 5 mm
- 7 TORX®/TX (gelb/yellow) T10 - 15 - 20 - 25 - 27 - 30 - 40

Art.-Nr./Art.No.	G./S.	tlg./pcs	B	L	H
4093	1/4"	18	155	120	35
409306	1/4"	6 x 18	180	275	120
Display mit 6 Boxen 4093					

4090 PROFESSIONAL PLUS STANDARD

1/4" Color-Bit-Box XL

Color Bit Set „Color BIT Box XL“



71
tlg./pcs.



- 25 mm
- 6 Schlitz/Slotted (rot/red) 3x 4 mm / 3x 6 mm
- 12 Phillips/PH (dunkelrot/dark red) 3x PH 1 / 6x PH 2 / 3x PH 3
- 12 Pozidriv/PZ (blau/blue) 3x PZ 1 / 6x PZ 2 / 3x PZ 3
- 9 Inbus (orange) 3x 4 mm / 3x 5 mm / 3x 6 mm
- 21 TORX®/TX (gelb/yellow) 3x TX10 / 15 / 20 / 25 / 27 / 30 / 40

- 75 mm
- 2 Schlitz/Slotted (rot/red) 1x 4 mm / 1x 6 mm
- 3 Phillips/PH (dunkelrot/dark red) 1x PH 1 / 1x PH 2 / 1x PH 3
- 2 Pozidriv/PZ (blau/blue) 1x PZ 1 / 1x PZ 2
- 2 TORX®/TX (gelb/yellow) 1x TX20 / TX25

- 1 Bit Magnethalter
- 1 Bit Halter mit Schnellspannfutter

Art.-Nr./Art.No.	G./S.	tlg./pcs	B	L	H
4090	1/4"	71	155	120	35
409006	1/4"	6 x 71	185	375	120
Display mit 6 Boxen 4090					

Farbig markierte Bits erleichtern das Suchen der richtigen Größe.

Very easy to find the right size, because of colored bits.



375 x 185 x 120 mm
Höhe geöffnet/height open: 270 mm
Art. 409306
Display mit /with 6x 4093



375 x 185 x 120 mm
Höhe geöffnet/height open: 270 mm
Art. 409006
Display mit /with 6x 4090

1/4" BIT-Sätze

1/4" Bit Sets



Art.-Gruppe 132
Article Group 132

4094 PROFESSIONAL PLUS STANDARD

1/4" Color-Bit-Box 25 + 75 mm
Color Bit Set 25 + 75 mm

1/4"
56
tlg./pcs.



25 mm

- 6 Schlitz/Slotted (rot/red) 1x 4 - 5 - 6 mm
- 9 Phillips (dunkelrot/dark red) 3x PH 1 - 2 - 3
- 9 Pozidriv (blau/blue) 3x PZ 1 - 2 - 3
- 14 TORX® (gelb/yellow) 2x TX10-15-20-25-27-30-40
- 7 TORX® mit Loch (violett) 1x TX10-15-20-25-27-30-40
- 3 Inbus/Hex. (orange) 1x 2 - 2.5 - 3 - 4 - 5 - 6 mm

75 mm

- 1 Schlitz/Slotted (rot/red) 1x 6 mm
- 3 Phillips (dunkelrot/dark red) 1x PH 1 - 2 - 3
- 3 Pozidriv (blau/blue) 1x PZ 1 - 2 - 3
- 1 Bit Halter mit Schnellspannfutter/
Magnetic bit holder with quick release

4097 PROFESSIONAL PLUS STANDARD

Verbesserte Ausführung /
Improved Quality

**1/4" Universal Color-Bit-Box
mit Ratschenschraubendreher**
Universal Color Bit Set
with Ratchet Screwdriver

1/4"
60
tlg./pcs.



25 mm

- 2 Schlitz/Slotted (rot/red) 4 - 5 mm
- 4 Phillips (dunkelrot/dark red) PH 1 - 2 - 2 - 3
- 4 Pozidriv (blau/blue) PZ 1 - 2 - 2 - 3
- 6 TORX® (gelb/yellow) TX10-15-20-25-30-40
- 6 TORX® mit Loch (violett) TX10-15-20-25-30-40
- 6 Inbus (orange) 2 - 2,5 - 3 - 4 - 5 - 6 mm
- 10 magn. Stecknuss-Bits (orange) 5 - 5,5 - 6 - 7 - 8 - 9 - 10 - 11 - 12 - 13 mm
- 1 Stecknuss-Bit (blau/blue) 4 mm

75 mm

- 2 Phillips (dunkelrot/dark red) PH 1 - 2
- 2 Pozidriv (blau/blue) PZ 1 - 2
- 3 TORX® (gelb/yellow) TX15 - 20 - 25
- 2 Inbus (orange) 4 - 5 mm
- 1 Bit-Halter mit Schnellspannfutter/
Magnetic bit holder with quick release
- 1 Ratschenschraubendreher inkl. 10 Color-Bits/
Ratchet Screwdriver incl. 10 Color-Bits (Art-Nr. 4192)
- 2 Schlitz/Slotted (rot/red) 4 - 6 mm
- 2 Phillips (dunkelrot/dark red) PH 1 - 2
- 2 Pozidriv (blau/blue) PZ 1 - 2
- 2 TORX® (gelb/yellow) TX20 - 25
- 2 Inbus/Hex. (orange) 3 - 5 mm

Art.-Nr./Art.-No.	G./S.	tlg./pcs	B	L	H
4094	1/4"	56	127	95	34

Art.-Nr./Art.-No.	G./S.	tlg./pcs	B	L	H
4097	1/4"	60	268	187	60

4192	1/4"	1/4" Ratschenschraubendreher inkl. 10 Color-Bits/ 1/4" Ratchet Screwdriver incl. 10 Color-Bits			
419212	1/4"	12 x 11	160	215	245
		1/4" Ratschenschraubendreher-Display			

1/4" BIT-Sätze

1/4" Bit Sets

1/4"

Art-Gruppen 132/133
Article Groups 132/133

394073*

PROFESSIONAL PLUS STANDARD

1/4" Bit-Box mit Drehgriffknarre, 33-tlg.

1/4" Bit Set with Twist Handle Ratchet, 33 pcs.

1/4"
33
tlg./pcs.



- ▶ **Bit-Drehknarre: Ideal für das Arbeiten an extrem unzugänglichen Stellen**
- ▶ *Bit twist ratchet: Ideal for working on extremely narrow spaces*

25 mm

1		Schlitz/Slotted (rot/red)	4 mm	
3		Phillips/PH (dunkelrot/dark red)	PH1 - 2 - 3	
3		Pozidriv/PZ (blau/blue)	PZ1 - 2 - 3	
3		TORX®/TX (gelb/yellow)	TX15 - 20 - 25	
3		Inbus/Hex (orange)	3 - 4 - 5 mm	
11		Stecknuss-Bits	4-5-5,5-6-7-8-9-10-11-12-13 mm	
2		Adapter	1/4"x1/4" + 1/4"x3/8"	

50 mm

2		Phillips/PH (dunkelrot/dark red)	PH1 - 2	
2		TORX®/TX (gelb/yellow)	TX10 - 20	
2		Inbus/Hex (orange)	4 - 6 mm	
1		1/4" Bit-Drehgriffknarre/Twist handle ratchet		

Art.-Nr./Art.-No.	G./S.	tlg./pcs	B	L	H
394073*	1/4"	33	200	120	40

*Lieferung nur solange der Vorrat reicht / Delivery while stocks last



1/4" BIT-Sätze

1/4" Bit Sets



Art.-Gruppen 132/133
Article Groups 132/133

3790 PROFESSIONAL PLUS STANDARD

1/4" SECURIBIT-Box 75 mm 50-teilig

SECURIBIT-Set 75 mm, 50 pieces



50
tlg./pcs.



3788 PROFESSIONAL PLUS STANDARD

1/4" Bit Box 75 mm, 36-teilig

Bit Set, 36 pieces



36
tlg./pcs.



3	☉	Schlitz/Slotted	4 - 5 - 6 mm
2	⊕	Phillips/PH	PH 1 - 2
2	⊕	Pozidriv/PZ	PZ 1 - 2
3	⊙	Inbus/Hex	4 - 5 - 6 mm
6	⊙	Inbus mit Bohrung/ Tamper Hex	2 - 2,5 - 3 - 4 - 5 - 6 mm
5	⊗	TORX®/TX	T10 - 15 - 20 - 25 - 30
9	⊗	TORX® mit Bohrung/ Tamper TX	T8 - 10 - 15 - 20 - 25 - 27 - 30 - 35 - 40
2	□	Robertson	Nr. 1 - 2
3	⊕	Torg	6 - 8 - 10 mm
4	⊕	Tri-Wing	Nr. 1 - 2 - 3 - 4
4	⊕	Spanner	4 - 6 - 8 - 10 mm
3	⊕	Clutch	Nr. 1 - 2 - 3
1		Magnethalter	

Bits aus CRV-Stahl · Gewicht/Weight: 900 g

Art.-Nr./Art.-No.	G./S.	tlg./pcs	B	L	H
3790	1/4"	50	193	137	36

4	☉	Schlitz/Slotted	3 - 4 - 5 - 6 mm
5	⊕	Phillips/PH	2 x PH 1 - 2, 1 x PH 3
5	⊕	Pozidriv/PZ	2 x PZ 1 - 2, 1 x PZ 3
7	⊗	TORX®/TX	T10 - 15 - 20 - 25 - 27 - 30 - 40
8	⊗	TORX® mit Bo./Tamper TX	T8 - 10 - 15 - 20 - 25 - 27 - 30 - 40
6	⊙	Inbus/Hex	2 - 2,5 - 3 - 4 - 5 - 6 mm
1		Magnethalter	

Bits aus CRV-Stahl · Gewicht/Weight: 720 g

Art.-Nr./Art.-No.	G./S.	tlg./pcs	B	L	H
3788	1/4"	36	190	130	36

1/4" BIT-Sätze

1/4" Bit Sets



Art.-Gruppe 133
Article Group 133

3789

PROFESSIONAL PLUS STANDARD

1/4" SECURIBIT Box

„zu jeder Schraube den richtigen Bit“

SECURIBIT Set „for every screw the right bit“



122
tlg./pcs.



3787

PROFESSIONAL PLUS STANDARD

1/4" SECURIBIT Box

„zu jeder Schraube den richtigen Bit“

SECURIBIT Set „for every screw the right bit“



100
tlg./pcs.



9	⊖	Schlitz/Slotted	3 - 4 - 4,5 - 5 - 5,5 - 6 - 6,5 - 7 - 8
5	⊕	Phillips/PH	PH 00 - 0 - 1 - 2 - 3
5	⊕	Pozidriv	PZ 00 - 0 - 1 - 2 - 3
9	⊙	Inbus/Hex	1,5 - 2 - 2,5 - 3 - 4 - 5 - 5,5 - 6 - 8 mm
10	⊙	Inbus/Hex	1/16" - 5/64" - 3/32" - 7/64" - 1/8" - 9/64" - 5/32" - 3/16" - 7/32" - 1/4"
6	⊙	Inbus mit Bohrung	2 - 2,5 - 3 - 4 - 5 - 6 mm
9	⊙	5-Stern mit Bohrung	TS10 - 15 - 20 - 25 - 27 - 30 - 40 - 45 - 50
13	⊙	TORX®/TX	T5 - 6 - 7 - 8 - 9 - 10 - 15 - 20 - 25 - 27 - 30 - 40 - 45
9	⊙	TORX® mit Bohrung/ Tamper TX	T8 - 10 - 15 - 20 - 25 - 27 - 30 - 35 - 40
4	□	Robertson	Nr. 0 - 1 - 2 - 3
3	⊕	Torg	6 - 8 - 10 mm
4	⊕	Tri-Wing	Nr. 1 - 2 - 3 - 4
4	⊕	Spanner	4 - 6 - 8 - 10 mm
3	⊕	Clutch	Nr. 1 - 2 - 3
3	⊕	Vielzahn	M5 - 6 - 8
10	○	Stecknuss Bit	4 - 5 - 6 - 7 - 8 - 9 - 10 - 11 - 12 - 13 mm
10	○	Stecknuss Bit	5/32" - 3/16" - 7/32" - 1/4" - 9/32" - 5/16" - 11/32" - 3/8" - 7/16" - 1/2"
1		Eindreh-Bit für Haken	
1		Magnethalter	
1		Universal Bit- Schraubendreher mit Dauermagnet	
1		Bit Adapter	1/4" x 1/4"
2		Stecknuss Adapter	25 + 50 mm

Bits aus CRV-Stahl · Gewicht/Weight: 1.160 g

Art.-Nr./Art.-No.	G./S.	tlg./pcs	B	L	H
3789	1/4"	122	220	155	50

9	⊖	Schlitz/Slotted	3 - 4 - 4,5 - 5 - 5,5 - 6 - 6,5 - 7 - 8
8	⊕	Phillips/PH	PH 0 - 1 - 3, 5 x PH 2
8	⊕	Pozidriv	PZ 0 - 1 - 3, 5 x PZ 2
9	⊙	Inbus/Hex	1,5 - 2 - 2,5 - 3 - 4 - 5,5 - 6 - 8 mm
10	⊙	Inbus/Hex	1/16" - 5/64" - 3/32" - 7/64" - 1/8" - 9/64" - 5/32" - 3/16" - 7/32" - 1/4"
6	⊙	Inbus mit Bohrung	2 - 2,5 - 3 - 4 - 5 - 6 mm
6	⊙	Inbus mit Bohrung	5/64" - 3/32" - 7/64" - 1/8" - 9/64" - 5/32"
9	⊙	TORX®/TX	T8 - 10 - 15 - 20 - 25 - 27 - 30 - 35 - 40
9	⊙	TORX® mit Bohrung/ Tamper TX	T8 - 10 - 15 - 20 - 25 - 27 - 30 - 35 - 40
4	□	Robertson	Nr. 0 - 1 - 2 - 3
3	⊕	Torg	6 - 8 - 10 mm
4	⊕	Tri-Wing	Nr. 1 - 2 - 3 - 4
4	⊕	Spanner	4 - 6 - 8 - 10 mm
3	⊕	Clutch	Nr. 1 - 2 - 3
3	⊕	Vielzahn	M5 - 6 - 8
1		Eindreh-Bit für Haken	
1		Magnethalter	
1		Bit Adapter	1/4" x 1/4"
2		Stecknuss Adapter	25 + 50 mm

Bits aus CRV-Stahl · Gewicht/Weight: 700 g

Art.-Nr./Art.-No.	G./S.	tlg./pcs	B	L	H
3787	1/4"	100	190	130	36

1/4" BIT-Sätze

1/4" Bit Sets



Art.-Gruppe 133
Article Group 133

8604

1/4" Bit Box XL, 113-teilig

Bit Set „BIT Box XL“ with 113 pieces



113
tlg./pcs.



25 mm

7	☉	Schlitz/Slotted	4 - 4 - 4 - 6 - 6 - 6 - 6 mm
14	⊕	Phillips/PH	4x PH 1 - 7x PH 2 - 3x PH 3
14	⊕	Pozidriv/PZ	4x PZ 1 - 7x PZ 2 - 3x PZ 3
7	⊙	Inbus/Hex	4 - 4 - 5 - 5 - 5 - 6 - 6 mm
49	⊗	TORX®/TX	7x TX10 - 15 - 20 - 25 - 27 - 30 - 40
7	⊗	TORX® mit Bo./ Tamper TX	TX10 - 15 - 20 - 25 - 27 - 30 - 40

75 mm

4	⊕	Phillips/PH	PH 1 - PH 2 - PH 2 - PH 3
4	⊕	Pozidriv/PZ	PZ 1 - PZ 2 - PZ 2 - PZ 3
5	⊗	TORX®/TX	TX10 - 15 - 20 - 25 - 30
1		Bit Magnethalter	
1		Bit Halter mit Schnellspannfutter	

Bits aus CRV-Stahl

Größe/Size: 1/4" · tlg./pcs 113 · BxLxH/WxLxH: 120x205x45 mm

Gewicht/Weight: 1.120 g

Art.-Nr./Art.-No.	G./S.	tlg./pcs	B	L	H
8604	1/4"	113	205	120	45

1/4" BIT-Sätze

1/4" Bit Sets

1/4"

Art.-Gruppe 133
Article Group 133**8606****1/4" Bit-Box XXL, 200-teilig**
„zu jeder Schraube den richtigen Bit“Bit Box XXL 200 pieces
„for every screw the right bit“

1/4"

200
tlg./pcs.**25 mm**

12	☉	Schlitz/Slotted	2 - 2,5 - 3 - 3,5 - 4 - 4,5 - 5 - 5,5 - 6 - 6,5 - 7 - 8 mm
18	⊕	Phillips/PH	1x PH 00 - 1x PH 0 - 5x PH 1 - 5x PH 2 - 5x PH 3 - 1x PH 4
17	⊕	Pozidriv/PZ	1x PZ 00 - 1x PZ 0 - 5x PZ 1 - 5x PZ 2 - 4x PZ 3 - 1x PZ 4
12	⊙	Inbus/Hex	1,5 - 2 - 2,5 - 3 - 3,5 - 4 - 4,5 - 5 - 5,5 - 6 - 7 - 8 mm
10	⊙	Inbus/Hex	1/16" - 5/64" - 3/32" - 7/64" - 1/8" - 9/64" - 5/32" - 3/16" - 7/32" - 1/4"
6	⊙	Inbus mit Bohrung	2 - 2,5 - 3 - 4 - 5 - 6 mm
6	⊙	Inbus mit Bohrung	5/64" - 3/32" - 7/64" - 1/8" - 9/64" - 5/32"
9	☆	5-Stern mit Bohrung	TS10 - 15 - 20 - 25 - 27 - 30 - 40 - 45 - 50
13	⊗	TORX®/TX	T5 - 6 - 7 - 8 - 9 - 10 - 15 - 20 - 25 - 27 - 30 - 40 - 45
14	⊗	TORX® mit Bo./Tammer TX	T5 - 6 - 7 - 8 - 9 - 10 - 15 - 20 - 25 - 27 - 30 - 35 - 40 - 45
4	□	Robertson	Nr. 0 - 1 - 2 - 3
3	⊕	Torq	6 - 8 - 10 mm
4	⊖	Tri-Wing	Nr. 1 - 2 - 3 - 4
4	⊗	Spanner	4 - 6 - 8 - 10 mm
3	⊙	Clutch	Nr. 1 - 2 - 3
3	⊙	Vielzahn	M5 - 6 - 8

50 mm

2	⊕	Phillips/PH	PH 2 - 3
2	⊕	Pozidriv/PZ	PZ 2 - 3
4	⊙	Inbus/Hex	3 - 4 - 5 - 6 mm
7	⊗	TORX® mit Bohrung/ /Tammer TX	T10 - 15 - 20 - 25 - 27 - 30 - 40
3	⊕	Torq	6 - 8 - 10 mm
4	⊖	Tri-Wing	Nr. 1 - 2 - 3 - 4
4	⊗	Spanner	4 - 6 - 8 - 10 mm

75 mm

2	⊕	Phillips/PH	PH 2 - 3
4	⊙	Inbus/Hex	3 - 4 - 5 - 6 mm
7	⊗	TORX® mit Bohrung/ Tammer TX	T10 - 15 - 20 - 25 - 27 - 30 - 40

38 mm

10		Stecknuss Bit	4 - 5 - 6 - 7 - 8 - 9 - 10 - 11 - 12 - 13 mm
10		Stecknuss Bit	5/32" - 3/16" - 7/32" - 1/4" - 9/32" - 5/16" - 11/32" - 3/8" - 7/16" - 1/2"
1		Magnethalter 60 mm	
1		Magnethalter mit Schnellspannfutter 65 mm	
1		Stecknuss Adapter	1/4" 25 mm

Bits aus CV-Stahl

Größe/Size: 1/4" · tlg./pcs 200 · BxLxH/WxLxH: 220x155x50 mm

Gewicht/Weight: 2.000 g

Art.-Nr./Art.-No.	G./S.	tlg./pcs	B	L	H
8606	1/4"	200	335	200	45

1/4" BIT-Sätze

1/4" Bit Sets



Art.-Gruppen 130/131
Article Groups 130/131

PROFESSIONAL PLUS STANDARD

1/4" Stecknuss Bit Adapter Satz, 3-tlg. 50 mm für Stecknüsse 1/4", 3/8", 1/2"

Bit Adapter Set, 3 pieces

50 mm For Sockets 1/4", 3/8", 1/2"

3
tlg./pcs.



Art.-Nr./Art.-No.	Größe/Size	Länge/Length
2880	1/4" x 1/4"	50 mm
	1/4" x 3/8"	50 mm
	1/4" x 1/2"	50 mm

PROFESSIONAL PLUS STANDARD

1/4" Sätze Stecknuss Bit mit Magnet, 65 mm

1/4" Magnetic Nut Setter Sets, 65 mm



Abb. ähnlich/picture similar

Art.-Nr./Art.-No.	Größe/Size
3784-91	7 - 8 - 10 - 13 mm (4-tlg. Satz)
3784-92	1/4" - 3/8" - 5/16" (3-tlg. Satz)
3784-93	5,5 - 6 - 7 - 8 - 10 - 12 - 13 - 17 mm (8-tlg. Satz)

Bit-Display / Magazin

Bit Display / Storage



**Fragen Sie nach unseren Bestückungen –
das Display kann auch individuell nach
Kundenwunsch bestückt werden!**

Please ask for different contents –
the display content can be individualised due to your needs!

Art.-Gruppe 131
Article Group 131

11911-01

615 x 503 x 150 mm

Reihe 1/Line 1:

- ⊕ 25 mm 30 x PH1 - 50 x PH2 - 30 x PH3
- ⊕ 25 mm TiN 20 x PH1 - 30 x PH2 - 20 x PH3
- ⊕ 50 mm 20 x PH2
- ⊕ 25 mm 10 x Schraubvorsatz mit Tiefenstopp PH2
- 50 mm Stecknuss Bit Adapter 1/4" x 1/4"

Reihe 2/Line 2:

- ⊕ 25 mm 30 x PZ1 - 50 x PZ2 - 30 x PZ3
- ⊕ 25 mm TiN 20 x PZ1 - 30 x PZ2 - 20 x PZ3
- ⊕ 50 mm 10 x PZ1 - 20 x PZ2 - 10 x PZ3

Reihe 3/Line 3:

- ⊙ 25 mm 20 x TX10 - 20 x TX15 - 50 x TX20 -
50 x TX 25 - 50 x TX30 - 20 x TX 40
- ⊙ 25 mm TiN 30 x TX15 - 30 x TX 20 - 30 x TX 25

Reihe 4/Line 4:

- 65 mm Stecknuss Bit 6 x 8 mm - 6 x 10 mm - 5 x 13 mm
- 10 x Bit Magnethalter
- 10 x Magnethalter mit Schnellspannfutter
- 10 x Magnethalter mit „Ring-Magnet“

Art.-Nr./Art.-No.	tlg./pcs.	
11911-01	787	bestückt mit 787 Bits / with 787 Bits

Schraubendreher & Winkelstiftschlüssel

Screwdriver & Hex Keys

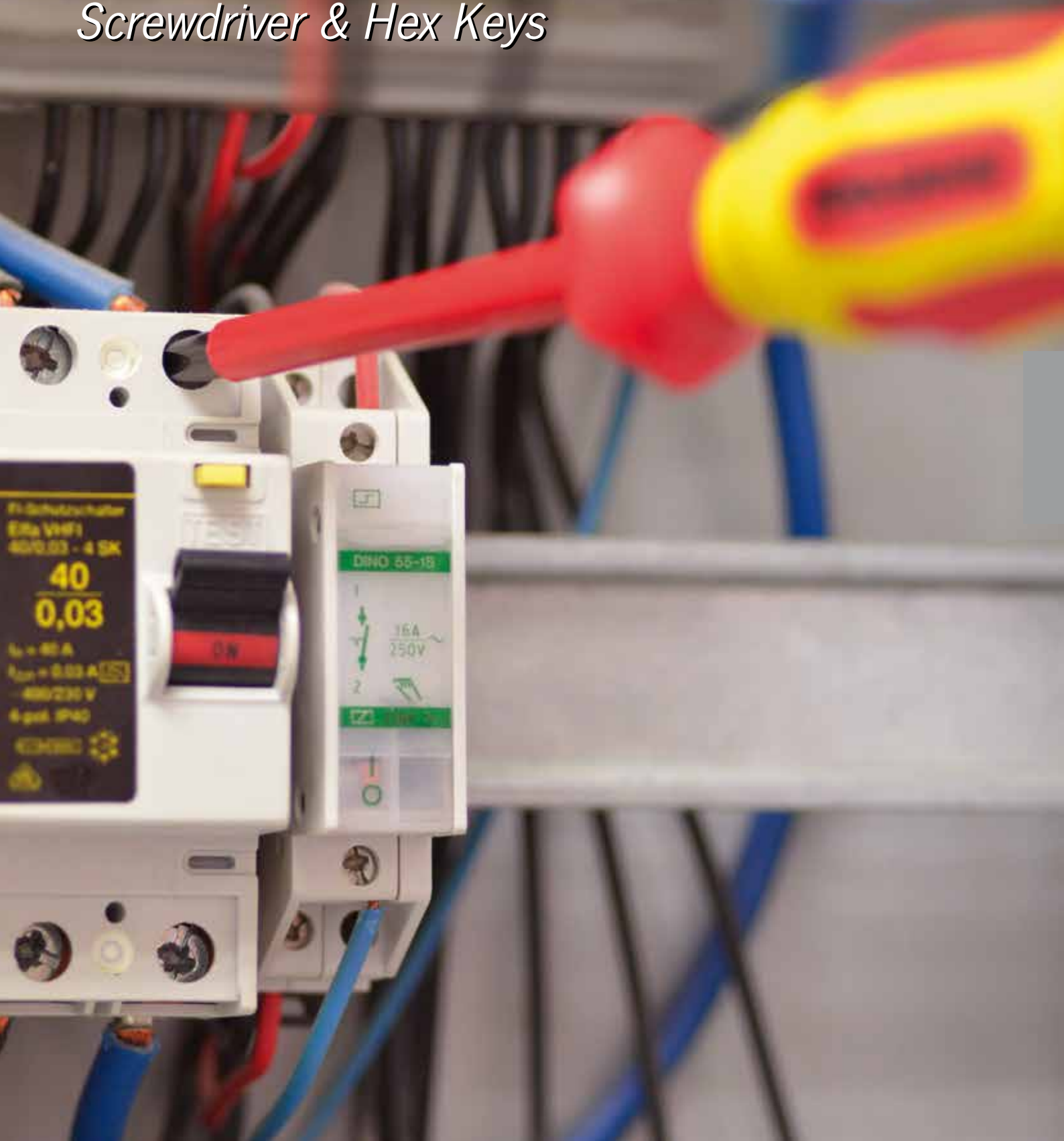

Schraubendreher – Die ergonomischen Allrounder

Screwdriver – The ergonomic all-rounders



Ergonomisch

Ergonomic

- ▶ Hohe Kraftübertragung durch optimale Anpassung des Mehrkomponentengriffs an die Hand
 - ▶ Kein Durchrutschen der Hand auf Grund der Kombination weicher und fester Werkstoffe für den Griff
 - ▶ Rutschfeste Oberfläche minimiert das Durchrutschen der Hand auch bei öligen oder fettigen Händen
 - ▶ Optimale Kraftübertragung von Griff auf Klinge durch komplett in den Griff eingearbeiteten Klingenschaft
 - ▶ 6-kant Schlüsselhilfe ermöglicht das Lösen von extrem fest sitzenden Schrauben (Ausführung mit Schlagkappe)
- ▶ High power transmission due to a optimized multi-component handle*
- ▶ No slipping of the hand because of a combination of soft and hard materials for the handle*
- ▶ Non-slip surface minimizes slipping also with oily or greasy hands*
- ▶ Optimized power transmission due to a secure connection between handle and blade*
- ▶ Hexagonal holding fixture enables the loosen of jammed screws (Version with impact cap)*



Strapazierfähig und langlebig

Hardwearing and Durable

- ▶ Speziell für den professionellen Einsatz durch hochlegierten Spezialstahl geeignet
 - ▶ Langlebige und stabile Klingenspitze durch optimierte Klingeneigenschaften in Bezug auf Härte und Zähigkeit
 - ▶ Weniger Verschleiß an Klingenspitze und Schraube durch präzise ausgearbeitet Klinge
 - ▶ Für besonders hohe Belastungen und Schlagkappe erhältlich
- ▶ Especially for the professional usage due to high alloyed special steel*
- ▶ Durable and robust tip because of an optimized hardness of the material*
- ▶ Less wearing at the tip and the screw due to a high quality blade tip*
- ▶ Version with impact cap for extreme demanding applications*

Vielseitig

Versatile

- ▶ Für jeden Anwender der richtiger Schraubendreher durch breites Produktsortiment
 - ▶ Für sicheres Arbeiten an elektrischen Anlagen als VDE-Version erhältlich
 - ▶ Für härteste Anwendungen auch als Version mit Schlagkappe
 - ▶ 6-in-1 Universal Schraubendreher für PH- und PZ-Schrauben der Größen 1 bis 3 – ein Schraubendreher für 6 Anwendungen
 - ▶ Große Produktauswahl an perfekt abgestimmten Sets
- ▶ For every user the right screwdriver due to a wide product range*
- ▶ As VDE-Versions available – Safety working on electrical installations*
- ▶ For extreme demanding applications also as version with impact cap available*
- ▶ 6-in-1 Universal Screwdriver for PH- and PZ-Drives with sizes from 1 to 3 – only one screwdriver for 6 applications*
- ▶ Wide product range of perfect customized sets*

Sicherheit

Safety

- ▶ Höchste Sicherheit bei Arbeiten an elektrischen Anlagen durch Prüfung nach DIN-EN 60900 und IEC 900 (VDE-Ausführung)
 - ▶ Verminderung der Abrutschgefahr der Hand durch optimierte Griffform
- ▶ Highest safety during working on electrical installations due to tests according to DIN-EN 60900 and IEC 900 (VDE-Version)*
- ▶ Optimized handle reduces the risk of slipping*

* Phillips® und Pozidriv® sind eingetragene Markenzeichen der Firma Phillips Screw Co.
TORX® und tamper TORX® sind eingetragene Markenzeichen der Firma Camcar/Textron

* Phillips® and Pozidriv® are registered trademarks of the company Phillips Screw Co.
TORX® and tamper TORX® are registered trademarks of the company Camcar/Textron



Schraubendreher für Schlitz-Schrauben

Slotted Screwdriver

Art.-Gruppen 140/145
Article Groups 140/145

Schraubendreher für Schlitz-Schrauben

Slotted Screwdriver



Art.-Nr./Art.-No.	Klingenstärke/Blade Thickness	Klingenbreite/Blade Width	Klingenlänge/Blade Length
4620-01	0,5 mm	3,0 mm	75 mm
4620-02	0,8 mm	4,0 mm	100 mm
4620-03	1,0 mm	5,5 mm	125 mm
4620-04	1,2 mm	6,5 mm	150 mm
4620-05	1,2 mm	8,0 mm	175 mm
4622-01	1,2 mm	6,5 mm	25 mm

Schraubendreher für Schlitz-Schrauben mit Schlagkappe

Slotted Screwdriver with Impact Cap



inkl. Schlüsselhilfe
incl. Wrench Adapter



Robuste Schlagkappe
Impact Cap



Art.-Nr./Art.-No.	Klingenstärke/Blade Thickness	Klingenbreite/Blade Width	Klingenlänge/Blade Length	SW/Size
5120-02	0,8 mm	4,5 mm	90 mm	8 mm
5120-03	1,0 mm	5,5 mm	100 mm	10 mm
5120-04	1,2 mm	7,0 mm	125 mm	10 mm
5120-05	1,2 mm	8,0 mm	150 mm	13 mm

Schraubendreher für Schlitz-Schrauben

Slotted Screwdriver



Art.-Nr./Art.-No.	Klingenstärke/Blade Thickness	Klingenbreite/Blade Width	Klingenlänge/Blade Length	
4120-01	0,5 mm	3,0 mm	75 mm	
4120-02	0,8 mm	4,0 mm	100 mm	
4120-03	1,0 mm	5,5 mm	125 mm	
4120-04	1,2 mm	6,5 mm	150 mm	
4120-05	1,6 mm	8,0 mm	150 mm	
4120-06	1,6 mm	10,0 mm	200 mm	
4122-01	1,2 mm	6,5 mm	38 mm	Vergaser

Schraubendreher für Kreuzschlitz-Schrauben Phillips

Phillips Screwdriver



Art.-Gruppen 140/145
Article Groups 140/145

Schraubendreher für Kreuzschlitz-Schrauben Phillips

Phillips Screwdriver



Art.-Nr./Art.-No.	Größe/Size	Klingenlänge/Blade Length
4600-00	0	60 mm
4600-01	1	80 mm
4600-02	2	100 mm
4600-03	3	150 mm
4602-01	1	25 mm
4602-02	2	25 mm

Schraubendreher für Kreuzschlitz-Schrauben Phillips mit Schlagkappe

Phillips Screwdriver with Impact Cap



inkl. Schlüsselhilfe
incl. Wrench Adapter



Robuste Schlagkappe
Impact Cap



Art.-Nr./Art.-No.	Größe/Size	Klingenlänge/Blade Length	Schlüsselhilfe/Wrench Adapter
5100-01	1	80 mm	8 mm
5100-02	2	100 mm	10 mm

Schraubendreher für Kreuzschlitz-Schrauben Phillips

Phillips Screwdriver



Art.-Nr./Art.-No.	Größe/Size	Klingenlänge/Blade Length	Art.-Nr./Art.-No.	Größe/Size	Kl/Bl	
4100-00	0	60 mm	4102-02	2	38 mm	Vergaser
4100-01	1	80 mm				
4100-02	2	100 mm				
4100-03	3	150 mm				

Schraubendreher für Kreuzschlitz-Schrauben Pozidriv*Pozidriv Screwdriver*
Art.-Gruppen 140/145
Article Groups 140/145
Schraubendreher für Kreuzschlitz-Schrauben Pozidriv*Pozidriv Screwdriver*

Art.-Nr./Art.-No.	Größe/Size	Klingenlänge/Blade Length
4610-00	0	60 mm
4610-01	1	80 mm
4610-02	2	100 mm
4610-03	3	150 mm

Schraubendreher für Kreuzschlitz-Schrauben Pozidriv*Pozidriv Screwdriver*

Art.-Nr./Art.-No.	Größe/Size	Klingenlänge/Blade Length
4110-00	0	60 mm
4110-01	1	80 mm
4110-02	2	100 mm
4110-03	3	150 mm

6-in-1 Universal Schraubendreher für Kreuzschlitz-Schrauben Phillips und Pozidriv*6-in-1 Universal Phillips and Pozidriv Screwdriver*▶ **Ein Schraubendreher für 6 Schraubenantriebe:****Phillips 1 - 2 - 3 und Pozidriv 1 - 2 - 3**▶ *One Screwdriver for 6 screw drives:**PH 1 - 2 - 3 and PZ 1 - 2 - 3*

Art.-Nr./Art.-No.	Größe/Size	Klingenlänge/Blade Length
4600-1230	PH 1 - 3 / PZ 1 - 3	100 mm
4600-1231	PH 1 - 3 / PZ 1 - 3	25 mm

Schraubendreher für Innen-TX-Schrauben

Tamper TX Screwdriver



Art.-Gruppen 140/145
Article Groups 140/145

Schraubendreher für Innen-TX-Schrauben

TX Screwdriver



Art.-Nr./Art.-No.	Größe/Size	Klingenlänge/Blade Length
4630-08	T8	60 mm
4630-10	T10	80 mm
4630-15	T15	80 mm
4630-20	T20	100 mm

Art.-Nr./Art.-No.	Größe/Size	Klingenlänge/Blade Length
4630-25	T25	100 mm
4630-27	T27	115 mm
4630-30	T30	115 mm
4630-40	T40	130 mm

Schraubendreher für Innen-TX-Schrauben

TX Screwdriver



Art.-Nr./Art.-No.	Größe/Size	Klingenlänge/Blade Length
4130-05	T5	50 mm
4130-06	T6	60 mm
4130-07	T7	60 mm
4130-08	T8	60 mm
4130-09	T9	60 mm
4130-10	T10	80 mm

Art.-Nr./Art.-No.	Größe/Size	Klingenlänge/Blade Length
4130-15	T15	80 mm
4130-20	T20	80 mm
4130-25	T25	100 mm
4130-27	T27	115 mm
4130-30	T30	115 mm
4130-40	T40	130 mm

Schraubendreher für Innen-TX-Schrauben mit stirnseitiger Bohrung

Tamper TX Screwdriver



Art.-Nr./Art.-No.	Größe/Size	Klingenlänge/Blade Length
4150-08	T8	60 mm
4150-10	T10	80 mm
4150-15	T15	80 mm
4150-20	T20	100 mm

Art.-Nr./Art.-No.	Größe/Size	Klingenlänge/Blade Length
4150-25	T25	100 mm
4150-27	T27	115 mm
4150-30	T30	115 mm
4150-40	T40	130 mm



Universal Schraubendreher

Universal Screwdriver

Art.-Gruppen 140/145
Article Groups 140/145

Schraubendreher mit Sechskant Steckschlüssel, Flexibler Schaft

Hex Metric Screwdriver, Flexible



Art.-Nr./Art.-No.	Größe/Size	Länge/Length
4692-06	6 mm	150 mm
4692-07	7 mm	150 mm
4692-08	8 mm	150 mm

Schraubendreher mit 1/4" Bit Schnellspannfutter

Quick Release Bit Screwdriver



Art.-Nr./Art.-No.	Größe/Size
4690-02	1/4" mit Schnellspannfutter

Ratschenschraubendreher mit 1/4" Bit Magnethalter und 10 Color-Bits

Magnetic Bit Ratchet Screwdriver with 10 Color Bits



- ▶ Mit Ratschenfunktion
- ▶ Ratschenfunktion rechts/links umschaltbar
- ▶ With ratchet function
- ▶ Ratchet function right/left reversible

2	⊖	Schlitz/Slotted (rot/red)	4 - 5 mm
2	⊕	Phillips/PH (dunkelrot/dark red)	PH 1 - 2
2	⊕	Pozidriv/PZ (blau/blue)	PZ 1 - 2
2	⊗	TORX®/TX (gelb/yellow)	TX20 - 25
2	⦿	Inbus/Hex (orange)	3 - 5 mm
1		Ratschenschraubendreher	

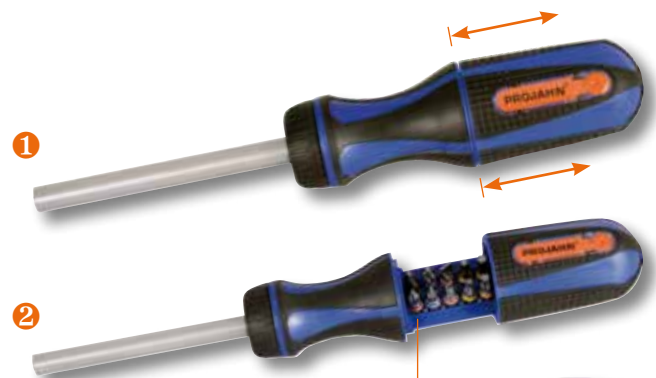

215 x 160 x 245 mm
Art. 419212
Display mit /with 12x 4192

Art.-Nr./Art.-No.	Größe/Size
4192	1/4" Ratschenschraubendreher inkl. 10 Color-Bits/Ratchet Screwdriver incl. 10 Color-Bits
419212	Display mit /with 12 x 4192 (1/4" Ratschenschraubendreher/Ratchet Screwdriver)

Präzisions-Schraubendrehersätze und Spannungsprüfer

Precision Screwdriver Sets and Voltage Tester



Art-Gruppen 140/145
Article Groups 140/145

PROFESSIONAL PLUS STANDARD

4711

Präzisions-Schraubendreher Satz

Precision Screwdriver Set



8
tlg./pcs.



Art.-Nr./Art.-No.	Größe/Size	Klingenlänge/Blade Length
4711	PH00 x 2 mm / PH0 x 3 mm / PH1 x 4 mm T6 x T10 - T7 x T15 - T8 x T20 - T9 x T15	Doppelklingen 120mm

PROFESSIONAL PLUS STANDARD

4714

30-in-1 Präzisions-Bit-Schraubendreher Satz

30-in-1 Precision Bit Screwdriver Set



31
tlg./pcs.

7	Schlitz/Slotted	1 - 1,5 - 2 - 2,5 - 3 - 3,5 - 4 mm
4	Phillips/PH	PH 000 - 00 - 0 - 1
2	Pozidriv/PZ	PZ 0 - 1
9	TORX®/TX	TX4 - 5 - 6 - 7 - 8 - 9 - 10 - 15 - 20
8	Inbus/Hex	0,7 - 0,9 - 1,3 - 1,5 - 2 - 2,5 - 3 - 4 mm
1	Präzisions-Bit-Schraubendreher/Precision Bit Screwdriver	

Art.-Nr./Art.-No.

4714

PROFESSIONAL PLUS STANDARD

EURO-Spannungsprüfer nach VDE 0680

Voltage Tester



1000V
EN 60900



Art.-Nr./Art.-No.	Größe/Size	
2137	3,0 x 60 mm	125 - 250 V

PROFESSIONAL PLUS STANDARD

Phasenprüfer 230 V

Voltage Tester



1000V
EN 60900



Art.-Nr./Art.-No.	Größe/Size	
2138	3,0 x 60 mm	110 - 230 V

VDE-Schraubendreher/Schraubendrehersortiment

Safety Insulated Screwdriver/Set



Art.-Gruppe 145
Article Group 145

Nach DIN EN 60900, IEC 900, Stückprüfung im Wasserbad mit einer Prüfspannung von 10.000 Volt. Kälteschlagprüfung bei -40° (Kennzeichnung C)

According to DIN EN 60900, IEC 900. Tested by 10.000 Volt.

VDE Schraubendreher für Kreuzschlitz-Schrauben Phillips

Phillips VDE Screwdriver



Art.-Nr./Art.-No.	Größe/Size	Klingenlänge/Blade Length
5105-00	0	60 mm
5105-01	1	80 mm
5105-02	2	100 mm

VDE Schraubendreher für Kreuzschlitz-Schrauben Pozidriv

Pozidriv VDE Screwdriver



Art.-Nr./Art.-No.	Größe/Size	Klingenlänge/Blade Length
5115-00	0	60 mm
5115-01	1	80 mm
5115-02	2	100 mm

VDE Schraubendreher für Schlitz-Schrauben

Slotted VDE Screwdriver



Art.-Nr./Art.-No.	Klingenstärke/Blade Thickness	Klingenbreite/Blade Width	Klingenlänge/Blade Length
5125-01	0,4 mm	2,5 mm	75 mm
5125-03	0,6 mm	3,5 mm	100 mm
5125-04	0,8 mm	4,0 mm	100 mm
5125-05	1,0 mm	5,5 mm	125 mm
5125-06	1,2 mm	6,5 mm	150 mm

6-in-1 Universal VDE Schraubendreher für Kreuzschlitz-Schrauben Phillips und Pozidriv

6-in-1 Universal VDE Phillips and Pozidriv Screwdriver

- ▶ Ein Schraubendreher für 6 Schraubenantriebe: Phillips 1 - 2 - 3 und Pozidriv 1 - 2 - 3

- ▶ One Screwdriver for 6 screw drives: PH 1 - 2 - 3 and PZ 1 - 2 - 3



Art.-Nr./Art.-No.	Größe/Size	Klingenlänge/Blade Length
5105-1230	PH 1 - 3 / PZ 1 - 3	100 mm

VDE Schraubendreher Satz, 7-teilig

VDE Screwdriver Sets, 7 pieces



7
tlg./pcs.



Art.-Nr./Art.-No.	Größe/Size
5190	0,4 x 2,5 - 0,8 x 4,0 - 1,0 x 5,5 - 1,2 x 6,5 mm PH 1 - 2, Spannungsprüfer 230 V

VDE Werkzeugsätze

VDE Tool Sets

Art.-Gruppe 113/145
Article Group 113/145

8687 PROFESSIONAL PLUS STANDARD

VDE Elektriker-Werkzeugmappe
VDE Electrical Tool Bag



PROJAHN
proficraft

12
tlg./pcs.

- ▶ Alle wichtigen Elektrowerkzeuge im Set
- ▶ Ideal für Elektro-, Heizung-, Sanitär-, Klima- und Belüftungstechnik
- ▶ Alle Werkzeuge VDE-geprüft nach DIN EN ISO 60900 bis 1.000 V
- ▶ Hochwertige Verarbeitung und Materialien, ergonomisches Design
- ▶ All important electrical tools in one set
- ▶ Designed for electrical engineering, heating systems, sanitary installation, climate control and ventilation technology
- ▶ All tools are VDE-tested accordingly DIN ISO 60900 up to 1.000 V
- ▶ High-quality workmanship and materials, Ergonomic design

- 3 ⊕ Phillips VDE-Schraubendreher PH0 - 1 - 2
- 3 ⊖ Schlitz VDE-Schraubendreher 2,5 - 4 - 6,5 mm
- 1 Spannungsprüfer 125 - 250 V
- 1 VDE Abisolierzange 150 mm
- 1 VDE Elektriker-Messer 150 mm
- 1 VDE Kombizange 150 mm
- 1 VDE Seitenschneider 150 mm
- 1 VDE Telefonzange 200 mm



Art.-Nr./Art.-No.
8687

5195 PROFESSIONAL PLUS STANDARD

VDE-Wechselklingen-Schraubendreher-Set
Electrical Screwdriver Set with interchangeable Blades



- ▶ Alle wichtigen VDE-Schraubendreher im handlichen Set
- ▶ Schnelles und sicheres Wechseln durch patentiertes Wechselklingensystem
- ▶ Durch aufsteckbare Drehkappe und Weichmantelzone auch ideal für die Feinelektronik
- ▶ Sicherheitsgeprüft nach DIN ISO 60900 bis 1.000 V
- ▶ Handlicher, rutschfester Griff
- ▶ In exklusiver, praktischer und platzsparender Gürtel-Rolltasche
- ▶ Reduziere Gefahr von Kratzern auf empfindlichen Untergründen
- ▶ All important VDE screwdrivers in one ergonomic set
- ▶ Patented changeable system for a safety and fast change of the blade
- ▶ Secure fit of blades, quickrelease button on handle against unwanted extraction
- ▶ Precision cap and soft-crip zone on blade for low torque application
- ▶ Due to push-on twist cap and soft-grip zone also ideal for fine electronic engineering
- ▶ Safety tested accordingly DIN ISO 60900 up to 1.000 V
- ▶ Ergonomic and non-slip handle
- ▶ In exclusive, practically and space-saving roll bag
- ▶ Roll bag reduces the risk of scratches on sensitive surfaces

- 5 ⊖ 2,5 x 0,4 / 3,0 x 0,5 / 3,5 x 0,6 / 4,0 x 0,8 / 5,5 x 1,0 mm
- 2 ⊕ PH1 - PH 2 1 Wechselgriff
- 1 ⊕ PZ 2 1 Drehkappe
- 2 ⊕ TX15 - 20

12
tlg./pcs.



Art.-Nr./Art.-No.
5195

Quergriff-Schraubendreher

T-Handle Screwdriver



Art.-Gruppe 140
Article Group 140

Quergriff Schraubendreher mit Kugelkopf für Innensechskant-Schrauben

T-Handle Screwdriver Ball Point



Art.-Nr./Art.-No.	Größe/Size	Länge/Length
4170-2	2,0 mm	100 mm
4170-25	2,5 mm	100 mm
4170-3	3,0 mm	100 mm
4170-4	4,0 mm	150 mm
4170-5	5,0 mm	150 mm
4170-6	6,0 mm	200 mm
4170-8	8,0 mm	200 mm
4170-10	10,0 mm	200 mm

Quergriff Schraubendreher Satz mit Kugelkopf für Innensechskant-Schrauben

T-Handle Screwdriver Ball Point Set

8
tlg./pcs.



Art.-Nr./Art.-No.	Größe/Size
4170	2 - 2,5 - 3 - 4 - 5 - 6 - 8 - 10 mm

Quergriff Schraubendreher für Innen-TX-Schrauben

T-Handle Screwdriver TX



Art.-Nr./Art.-No.	Größe/Size	Länge/Length
4180-10	TX 10	100 mm
4180-15	TX 15	100 mm
4180-20	TX 20	100 mm
4180-25	TX 25	100 mm
4180-27	TX 27	100 mm
4180-30	TX 30	150 mm
4180-40	TX 40	150 mm
4180-45	TX 45	150 mm
4180-50	TX 50	150 mm

Quergriff Schraubendreher Satz für Innen-TX-Schrauben

T-Handle Screwdriver TX Set

9
tlg./pcs.



Art.-Nr./Art.-No.	Größe/Size
4180	TX10 - TX15 - TX20 - TX25 - TX27 - TX30 - TX40 - TX45 - TX50

Quergriff Schraubendreher für Außensechskant-Schrauben

T-Handle Nut Driver

NEU/NEW



Art.-Nr./Art.-No.	Größe/Size	Länge/Length
4190-06	6 mm	225 mm
4190-07	7 mm	225 mm
4190-08	8 mm	225 mm
4190-10	10 mm	235 mm
4190-11	11 mm	235 mm
4190-12	12 mm	235 mm
4190-13	13 mm	235 mm
4190-14	14 mm	235 mm

Quergriff Schraubendreher Satz für Außensechskant-Schrauben

T-Handle Nut Driver Set

NEU/NEW

8
tlg./pcs.



Art.-Nr./Art.-No.	Größe/Size
4190	6 - 7 - 8 - 10 - 11 - 12 - 13 - 14 mm

Schraubendrehersätze

Screwdriver Sets

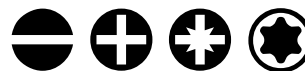

Art.-Gruppe 145
Article Group 145

Schraubendreher Satz

Screwdriver Set

6
tlg./pcs.



Art.-Nr./Art.-No.	Größe/Size
4621	PH 1 - 2 / 0,8 x 4,0 - 1,0 x 5,5 - 1,2 x 6,5 - 1,2 x 8,0 mm Phillips + Schlitz
4622	PZ 1 - 2 / 0,8 x 4,0 - 1,0 x 5,5 - 1,2 x 6,5 - 1,2 x 8,0 mm Pozidriv + Schlitz

Schraubendreher Satz

Screwdriver set

6
tlg./pcs.



Art.-Nr./Art.-No.	Größe/Size
4623	TX10 - TX15 - TX20 - TX25 - TX30 - TX40 TORX®

Schraubendreher Satz

Screwdriver Set

8
tlg./pcs.



Art.-Nr./Art.-No.	Größe/Size
4624	PH 1 - 2 / PZ 1 - 2 / TX10 - TX15 - TX20 - TX25 Phillips + Pozidriv + TORX

Schraubendreher Satz

Screwdriver Set

8
tlg./pcs.



Art.-Nr./Art.-No.	Größe/Size
4625	TX8 - TX10 - TX15 - TX20 - TX25 - TX27 - TX30 - TX40 TORX



Schraubendreher Satz mit durchgehender Klinge und Schlagkappe

Go-Through Screwdriver Set with Hammering Cap

6
tlg./pcs.



Art.-Nr./Art.-No.	Größe/Size
5199	PH 1 - 2 / 0,8 x 4,5 - 1,0 x 5,5 - 1,2 x 7,0 - 1,2 x 8,0 mm Phillips + Schlitz

inkl. Schlüsselhilfe
incl. Wrench Adapter



Robuste Schlagkappe
Hammering cap



Schraubendrehersätze

Screwdriver Sets



Art.-Gruppe 140
Article Group 140

Schraubendreher Sätze

Screwdriver Sets

8
tlg./pcs.



4725



Art.-Nr./Art.-No.	Größe/Size
4721	PH 1 - 2 / PZ 1 - 2 / TX10 - TX15 - TX20 - TX25 Phillips + Pozidriv + TORX®
4722	PH 1 - 2 / PZ 1 - 2 0,8 x 4,0 - 1,0 x 5,5 - 1,2 x 6,5 mm Bit-Magnethalter / Phillips + Pozidriv + Schlitz
4725	PH 1 - 2 / PZ 1 - 2 / TX20 - TX25 / 0,8 x 4,0 - 1,2 x 6,5 mm Phillips + Pozidriv + TORX® + Schlitz

Schraubendreher Satz

Screwdriver Set

6
tlg./pcs.



Art.-Nr./Art.-No.	Größe/Size
4727	PH 1 - 2 / 0,5 x 3,0 - 0,8 x 4,0 - 1,0 x 5,5 - 1,2 x 6,5 mm Phillips + Schlitz

Schraubendreher Sätze

Screwdriver Sets

8
tlg./pcs.



4723



Art.-Nr./Art.-No.	Größe/Size
4723	TX8 - TX10 - TX15 - TX20 - TX25 - TX27 - TX30 - TX40 TORX®
4724	TX8 - TX10 - TX15 - TX20 - TX25 - TX27 - TX30 - TX40 TX mit Bohrung/tamper TORX®

Weitere PROForm-Werkstatteinlagen ab Seite /
More PROForm Inlays for Roller Cabinet from Page H 32

Winkelstiftschlüssel und Sätze

Hex Keys and Sets



Art.-Gruppen 140/145
Article Groups 140/145

PROFESSIONAL PLUS STANDARD

Sechskant-Winkelstiftschlüssel matt-satiniert, verchromt, kurze Form nach DIN ISO 2936

Hex Keys, according to DIN ISO 2936, Short Version



Art.-Nr./Art.-No.	Größe/Size	L1	L2
3601-1.5	1,5 mm	14	45
3601-2	2,0 mm	16	50
3601-2.5	2,5 mm	18	56
3601-3	3,0 mm	20	63
3601-4	4,0 mm	25	70
3601-5	5,0 mm	28	80
3601-6	6,0 mm	32	90
3601-7	7,0 mm	34	95
3601-8	8,0 mm	36	100
3601-10	10,0 mm	40	112
3601-12	12,0 mm	45	125
3601-14	14,0 mm	56	140
3601-17	17,0 mm	63	160
3601-19	19,0 mm	70	180

PROFESSIONAL PLUS STANDARD

Sechskant-Kugelkopf-Winkelstiftschlüssel, matt-satiniert, verchromt, extra lange Form nach DIN ISO 2936

Ball Point Hex Keys, according to DIN ISO 2936, Extra Long Version



Art.-Nr./Art.-No.	Größe/Size	L1	L2
3602-1.5	1,5 mm	14	90
3602-2	2,0 mm	16	100
3602-2.5	2,5 mm	18	112
3602-3	3,0 mm	20	126
3602-4	4,0 mm	25	140
3602-5	5,0 mm	28	160
3602-6	6,0 mm	32	180
3602-7	7,0 mm	34	190
3602-8	8,0 mm	36	200
3602-10	10,0 mm	40	224
3602-12	12,0 mm	45	250
3602-14	14,0 mm	56	280
3602-17	17,0 mm	63	320

3601 PROFESSIONAL PLUS STANDARD

Sechskant-Winkelstiftschlüssel Satz 9-teilig im Halter, matt-satiniert, verchromt, kurze Form nach DIN ISO 2936

Hex Key Set, 9 pieces, Short Version, according to DIN ISO 2936



9
tig./pcs.

Art.-Nr./Art.-No.	Größe/Size
3601	1,5 - 2 - 2,5 - 3 - 4 - 5 - 6 - 8 - 10 mm

3602 PROFESSIONAL PLUS STANDARD

Sechskant-Kugelkopf-Winkelstiftschlüssel Satz 9-teilig im Halter, matt-satiniert, verchromt, extra lange Form nach DIN ISO 2936

Ball Point Hex Key Set, 9 pieces, according to DIN ISO 2936, Extra Long Version



9
tig./pcs.

Art.-Nr./Art.-No.	Größe/Size
3602	1,5 - 2 - 2,5 - 3 - 4 - 5 - 6 - 8 - 10 mm

3619 PROFESSIONAL PLUS STANDARD

Sechskant-Winkelstiftschlüssel Satz 8-teilig im Klapphalter, matt-satiniert, verchromt, nach DIN ISO 2936

Folding Hex Key Set, 8 pieces, according to DIN ISO 2936



8
tig./pcs.

Art.-Nr./Art.-No.	Größe/Size
3619	2,5 - 3 - 4 - 5 - 6 - 7 - 8 - 10 mm

3604 PROFESSIONAL PLUS STANDARD

Sechskant-Kugelkopf-Winkelstiftschlüssel Satz 8-teilig im Drehgriff-Halter, nach DIN ISO 2936

Ball Point Hex Key Set, 8 pieces, according to DIN ISO 2936, use the holder as a handle



8
tig./pcs.

Art.-Nr./Art.-No.	Größe/Size
3604	2 - 2,5 - 3 - 4 - 5 - 6 - 8 - 10 mm

Winkelstiftschlüssel und Sätze

Hex Keys and Sets



Art.-Gruppe 141
Article Group 141

PROFESSIONAL PLUS **STANDARD**

TX-Winkelstiftschlüssel matt-satiniert, verchromt, extra lange Form

TX Hex Keys, Extra Long Version



Art.-Nr./Art.-No.	Größe/Size	L1	L2
3607-10	T10	14	90
3607-15	T15	16	100
3607-20	T20	18	112
3607-25	T25	20	126
3607-27	T27	25	140
3607-30	T30	28	160
3607-40	T40	32	180
3607-45	T45	36	200
3607-50	T50	40	224

PROFESSIONAL PLUS **STANDARD**

BLUE EDITION Sechskant-Kugelkopf-Winkelstiftschlüssel, S2-Stahl, matt-satiniert, verchromt, extra lange Form, nach DIN ISO 2936

BLUE EDITION Ball Point Hex Key, S2 Steel, Extra Long Version, according to DIN ISO 2936



Art.-Nr./Art.-No.	Größe/Size	L1	L2
3613-015	1,5 mm	14	90
3613-020	2,0 mm	16	100
3613-025	2,5 mm	18	112
3613-030	3,0 mm	20	126
3613-040	4,0 mm	25	140
3613-050	5,0 mm	28	160
3613-060	6,0 mm	32	180
3613-070	7,0 mm	34	190
3613-080	8,0 mm	36	200
3613-100	10,0 mm	40	224
3613-120	12,0 mm	45	250
3613-140	14,0 mm	56	280
3613-170	17,0 mm	63	320
3613-190	19,0 mm	70	360

NEU/NEW

MAGNETISCHE KUGELKÖPFE

3607

PROFESSIONAL PLUS **STANDARD**

TX-Winkelstiftschlüssel Satz 9-teilig im Halter, matt-satiniert verchromt, extra lange Form

TX Hex Key Set, 9 pieces, Extra Long Version

9
tlg./pcs.

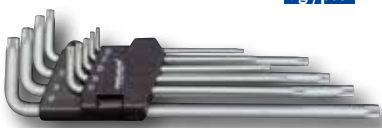

Art.-Nr./Art.-No.	Größe/Size
3607	T10-15-20-25-27-30-40-45-50

3613

PROFESSIONAL PLUS **STANDARD**

BLUE EDITION Sechskant-Kugelkopf-Winkelstiftschlüssel Satz 9-teilig im Halter, matt-satiniert, verchromt, extra lange Form nach DIN ISO 2936

Ball Point Hex Key Set, 9 pieces, Extra Long Version, according to DIN ISO 2936

- Kugelkopf mit integriertem Magnet, Schlüssel blau eloxiert
- Magnetic ball point, blue anodic treatment

MAGNETISCHE KUGELKÖPFE

9
tlg./pcs.



Art.-Nr./Art.-No.	Größe/Size
3613	1,5-2-2,5-3-4-5-6-8-10 mm

36131

PROFESSIONAL PLUS **STANDARD**

NEU/NEW

XXL BLUE EDITION Sechskant-Kugelkopf-Winkelstiftschlüssel Satz 13-teilig in Rolltasche, matt-satiniert, verchromt, extra lange Form nach DIN ISO 2936

XXL Ball Point Hex Key Set, 13 pieces, Extra Long Version, in pouch, according to DIN ISO 2936

MAGNETISCHE KUGELKÖPFE

13
tlg./pcs.



Art.-Nr./Art.-No.	Größe/Size
36131	1,5 - 2 - 2,5 - 3 - 4 - 5 - 6 - 8 - 10 - 12 - 14 - 17 - 19 mm



Winkelstiftschlüssel Sätze

Hex Key Sets



Art.-Gruppe 141
Article Group 141

PROFESSIONAL PLUS STANDARD

3603

Sechskant-Kugelkopf-Winkelstiftschlüssel Satz 9-teilig im Halter, Zoll, matt-satiniert, verchromt, extra lange Form nach DIN ISO 2936

Ball Point Hex Key Set, 9 pieces, Inch, Extra Long Version according to DIN ISO 2936

9
tlg./pcs.



Art.-Nr./Art.-No.

3603

Größe/Size

1/16"-5/64"-3/32"-1/8"-5/32"-3/16"-1/4"-5/16"-3/8"

PROFESSIONAL PLUS STANDARD

3617

Sechskant-Winkelstiftschlüssel Satz 9-teilig mit Multifunktionsgriff und TURBALL®-Kugelkopf, S2-Stahl, matt-satiniert, verchromt, extra lange Form nach DIN ISO 2936

TURBALL® Ball Point Hex Key Set with multifunction handle, Extra Long Version according to DIN ISO 2936

NEU/NEW

9
tlg./pcs.

- ▶ **Inklusive Multifunktionsgriff – ermöglicht Einsatz als T- oder Quer-Griff und erleichtert damit die Verschraubung**
- ▶ **TURBALL®-Kugelkopf**
 - Verschraubung auch bei schrägem Ansetzen möglich
 - Optimierte Kraftübertragung bei geradem Ansetzen gegenüber Standard-Kugelkopf
- ▶ **Mit integriertem Magnet (ab 3 mm)**
 - Schrauben aus Standard-Stahl haften am Werkzeug
- ▶ **Werkzeuge aus qualitativ hochwertigem S2-Stahl**
 - Hohe Festigkeit bei gleichzeitiger Flexibilität

- ▶ *Inclusive multifunction handle – allows use as T-handle or cross-handle*
- ▶ *TURBALL® ball head*
 - *Screwing also possible at angular collaring*
 - *Optimized force transmission compared to regular ball head*
- ▶ *With integrated magnet (from 3 mm on)*
 - *Standard steel screws adhere at the tool*
- ▶ *Made of high quality S2-steel*
 - *Low abrasion, high strength combined with flexibility*

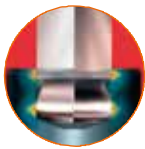

Art.-Nr./Art.-No.

3617

Größe/Size

1,5 - 2 - 2,5 - 3 - 4 - 5 - 6 - 8 - 10 mm

Zangen

Pliers



Zangen – Innovative Technik für clevere Handwerker

Pliers – Innovative Technique for Clever Craftsmen

Ergonomisch

Ergonomic

- ▶ Hohe Kraftübertragung durch optimale Anpassung des Mehrkomponentengriffs an die Hand
 - ▶ Rutschfeste Oberfläche minimiert das Abrutschen der Hand auch bei öligen oder fettigen Händen
 - ▶ Geringer Kraftaufwand und damit geringere Ermüdung durch ergonomisches und innovatives Design
 - ▶ Innovative Multifunktionszangen vermeiden lästige Werkzeugwechsel und sparen somit Zeit und Kosten
- ▶ High power transmission due to a optimized multi-component handle*
▶ Non-slip surface minimizes slipping also with oily or greasy hands
▶ Minimized efforts and fatigues due to an ergonomic design
▶ Innovative multifunctional pliers avoid frequent change of tools and therefore save time and money

Vielseitig

Versatile

- ▶ Für jeden Anwender die richtige Zange durch breites und innovatives Produktsortiment
 - ▶ Für sicheres Arbeiten an elektrischen Anlagen als VDE-Version erhältlich
 - ▶ Viele Anwendungen mit nur einem Werkzeug durch innovative Multifunktionszangen
 - ▶ Große Produktauswahl an perfekt abgestimmten Sets
- ▶ For every user the right plier due to a wide product range*
▶ As VDE-Versions available – Safety working on electrical installations
▶ Versatile applications with only one tool due to innovative multifunctional pliers
▶ Wide product range of perfect customized sets



Strapazierfähig und langlebig

Hardwearing and Durable

- ▶ Speziell für den professionellen Einsatz durch hochlegierten, Gesenk geschmiedeten und ölgehärteten Chrom-Vanadium-Stahl geeignet
 - ▶ Noch mehr Stabilität und Haltbarkeit durch induktiv gehärtete Präzisionsschneiden
 - ▶ Dauerhaft hohe Qualität durch prozessgesteuerte Fertigung entsprechend DIN- und ISO-Normen
- ▶ Especially for the professional usage due to high alloyed, drop-forged and oil-hardened Chrome-Vanadium-Steel*
▶ Even more durability and hardwearing due to induction hardened precision cutting edges
▶ Permanent high quality due to process-controlled production according DIN- and ISO-Standards

Sicherheit

Safety

- ▶ Höchste Sicherheit bei Arbeiten an elektrischen Anlagen durch Prüfung nach DIN-EN 60900 und IEC 900 (VDE-Ausführung)
 - ▶ Verminderung der Abrutschgefahr der Hand durch optimierte Griffform
 - ▶ Minimierung der Verletzungsgefahr durch in die Griffe eingearbeiteten Aufprallschutz
- ▶ Highest safety during working on electrical installations due to tests according to DIN-EN 60900 and IEC 900 (VDE-Version)*
▶ Optimized handle reduces the risk of slipping
▶ Minimization of the risk of injury due to handles with integrated anti-trap protection

Kombizangen und Seitenschneider

Combination Pliers and Side Cutters

Art.-Gruppe 155
Article Group 155

Kombizangen

Schneiden gehärtet

Combination Pliers

Art.-Nr./Art.-No.	Größe/Size
4601-165	165 mm
4601-180	180 mm



Profi Winkel-Kombizange 45°

Schneiden gehärtet

Professional Angle Combination Plier 45°

Art.-Nr./Art.-No.	Größe/Size
4601-200	180 mm
4601-20006*	Verkaufsdiskontroll mit 6x 4601-200

*Lieferung nur solange der Vorrat reicht / Delivery while stocks last

Induktiv gehärtete Schneide für harte und weiche Drähte, integrierter Ringschlüssel 11 – 17 mm / M8 – M10, spezielle Greifzone für Flach- und Rundmaterialien. Ideal für enge Stellen im Boden- und Deckenbereich. Größtmögliche Kraftübertragung, da die Hand in der natürlichen Position gehalten wird – kein Verdrehen des Handgelenkes. Perfekt geeignet für Arbeiten über Kopf



Induction hardened cutting edges for hard and soft wires, integrated ring wrench 11 to 17 mm / M8 to M10, special grip zones for flat and round materials. Best for tight spaces in floor and ceiling area. Maximum power transfer, when hand is in a natural position - no twisting of the hand joint. Perfect for working overhead

Seitenschneider

Schneiden gehärtet

Side Cutter

Induktiv gehärtete Präzisionsschneide, für Piano-Draht (D2-Qualität), enorme Schneidkraft, durch VPA-Remscheid ermittelt: 40 % Kraftersparnis

Precision cutting edges, induction hardened, for piano-wire (D2-quality), enormous cutting force, 40 % reduced effort attested by VPA-Remscheid



Art.-Nr./Art.-No.	Größe/Size	Typ/Model
4603-145	145 mm	Seitenschneider
4603-160	160 mm	Seitenschneider



Art.-Nr./Art.-No.	Größe/Size	Typ/Model
4604-180	180 mm	Hebel Kraft Seitenschneider



Art.-Nr./Art.-No.	Größe/Size	Typ/Model
4602-180	180 mm	Kraft Seitenschneider

Telefon-, Radio- und Abisolierzangen

Long Nose and Wire Stripping Pliers

Art-Gruppen 150/155
Article Groups 150/155

Telefon-/Radiozangen

Long Nose Pliers

DIN ISO 5745, induktiv gehärtete Schneide,
gezahnte Greifflächen, lange, gerade, flachrunde Backen

DIN ISO 5745, induction hardened cutting edges,
serrated inside jaws, long, straight, flatround jaws

Art.-Nr./Art.-No.	Größe/Size	Typ/Model
4605-170	170 mm	Telefonzange
4605-200	205 mm	Telefonzange
4606-200	205 mm	Telefonzange 45°



45°

Abisolierzangen

mit Öffnungsfeder und V-förmiger Schneide
mit Stellschraube zum Einstellen für Drähte
und Litzen bis Ø 5 mm bzw. 10 mm²

Wire Stripping Pliers

Art.-Nr./Art.-No.	Größe/Size
4607-160	160 mm



Weitere PROForm-Werkstatteinlagen ab Seite /
More PROForm Inlays for Roller Cabinet from Page H 32

Wasserpumpenzangen, Armaturen-Zangenschlüssel und Eckrohrzangen

Waterpump Pliers, Plier Wrench for Fittings and Swedish Elbow Pipe Wrenches

Art.-Gruppe 155
Article Group 155

Wasserpumpenzangen

Waterpump Pliers

Art.-Nr./Art.-No.	Größe/Size
4609-175	175 mm
4609-240	240 mm
4609-300	300 mm
4609-400	400 mm



Wasserpumpenzange

Waterpump Pliers

Art.-Nr./Art.-No.	Größe/Size
4608-250	250 mm



Wasserpumpenzangen „MAXI MX“ mit Druckknopf-Einhandverstellung

Waterpump Pliers „MAXI MX“

Art.-Nr./Art.-No.	Größe/Size
4516-250	250 mm
4517-300	300 mm



Armaturen-Zangenschlüssel mit glattpolierten Greifflächen

Plier wrench for fittings

With smoothly polished gripping surfaces

Art.-Nr./Art.-No.	Größe/Size	Länge/Length
4618-250	1"	250 mm



Schwedische Eckrohrzangen

S-förmiges Maul

Swedish Elbow Pipe Wrench

Art.-Nr./Art.-No.	Größe/Size	Länge/Length
4557-340	1"	340 mm
4557-430	1 1/2"	430 mm
4557-550	2"	550 mm



Art.-Nr./Art.-No.	Größe/Size	Winkel/Angle	Länge/Length
4559-340	1"	90°	340 mm
4559-430	1 1/2"	90°	430 mm
4559-550	2"	90°	550 mm
4559-650	3"	90°	650 mm



Wasserpumpen-, Eckrohr-, Flechter- und Kantenzangen

Waterpump Plier, Elbow Pipe Wrenches, KX-tower Pincers and Pincers

Art.-Gruppe 155
Article Group 155

Wasserpumpen- und Eckrohrzangen Satz, 3-tlg.

Waterpump and Elbow Pipe Wrench Set, 3 pcs.

3
tlg./pcs.

Art.-Nr./Art.-No.	Größe/Size
9985	Wasserpumpenzange/Waterpump Plier 240 mm + Schwedische Eckrohrzange/Elbow Pipe Wrench 1" + Schwedische Eckrohrzange/Elbow Pipe Wrench 1 1/2"



Bestehend aus Artikel 4609-240 + 4557-340 + 4557-430

Content item 4609-240 + 4557-340 + 4557-430

KX-Solinger Flechterzangen

KX-Tower Pincers

Schneiden gehärtet

Hardened Cutting Edges

Art.-Nr./Art.-No.	Größe/Size
4640-230	230 mm
4640-260	260 mm



Beiß-/Kantenzangen

Pincers

Art.-Nr./Art.-No.	Größe/Size
4643-180	180 mm
4643-210	210 mm



Weitere PROForm-Werkstatteinlagen ab Seite /
More PROForm Inlays for Roller Cabinet from Page H 32

Zangen VDE/EN 60900

Pliers VDE/EN 60900



Art-Gruppe 155
Article Group 155

Nach DIN EN 60900, IEC 900, Stückprüfung im Wasserbad mit einer Prüfspannung von 10.000 Volt.
Kälteschlagprüfung bei -40° (Kennzeichnung C)

According to DIN EN 60900, IEC 900. Tested by 10.000 Volt.



Art.-Nr./Art.-No.	Größe/Size	Typ/Model
4621-180	180 mm	Kraft Kombizange



Art.-Nr./Art.-No.	Größe/Size	Typ/Model
4629-160	160 mm	Kabelschneider
4629-210	210 mm	Kabelschneider



Art.-Nr./Art.-No.	Größe/Size	Typ/Model
4623-160	160 mm	Seitenschneider



Art.-Nr./Art.-No.	Größe/Size	Typ/Model
4622-180	180 mm	Kraft Seitenschneider



Art.-Nr./Art.-No.	Größe/Size	Typ/Model
4625-200	205 mm	Telefonzange



Art.-Nr./Art.-No.	Größe/Size	Typ/Model
4626-200	205 mm	Telefonzange 45°



Art.-Nr./Art.-No.	Größe/Size	Typ/Model
4627-160	160 mm	Abisolierzange



Art.-Nr./Art.-No.	Größe/Size	Typ/Model
4628-250	250 mm	Wasserpumpenzange

Multifunktionszangen VDE/EN 60900

Functional Pliers VDE/EN 60900



Art.-Gruppe 155
Article Group 155

**Nach DIN EN 60900, IEC 900, Stückprüfung im Wasserbad mit einer Prüfspannung von 10.000 Volt.
Kälteschlagprüfung bei -40° (Kennzeichnung C)**

According to DIN EN 60900, IEC 900. Tested by 10.000 Volt.

Profi Winkel-Kombizange 45°

Schneiden gehärtet

Professional Angle Combination Plier 45°

Art.-Nr./Art.-No.	Größe/Size
4621-200	180 mm
4621-20006*	Verkaufsdiskret mit 6x 4621-200

*Lieferung nur solange der Vorrat reicht / Delivery while stocks last

Technische Details entnehmen Sie bitte der Seite H 211 (4601-200)
Please find technical information on page H 211 (4601-200).



Multischneider 3-in-1

Multicutter 3-in-1

3 Funktionen mit einem Werkzeug

Abschneiden, Abmanteln, Abisolieren

One Tool – 3 Functions

Cut Off, Strip Cable, Strip Wire

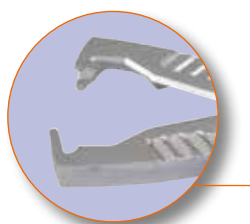

Art.-Nr./Art.-No.	Größe/Size	Typ/Model
4630-180	180 mm	Multischneider 3-in-1



ERGO Multifunktions-Elektrozange 45°

ERGO Multifunctional Electrician's Pliers

Schonendes und ermüdungsarmes Arbeiten

durch ergonomisches Zangendesign

Vereint viele Funktionen in einem Werkzeug

Strain-Free Working due to ergonomic design

Combines many different functions in one tool

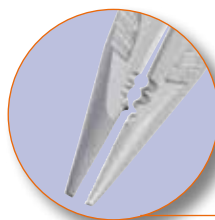

Art.-Nr./Art.-No.	Größe/Size	Typ/Model
4631-200	200 mm	ERGO Multifunktions-Elektrozange 45°



Sicherungsringzangen

Circlip Pliers

Art.-Gruppen 150/155
Article Groups 150/155

PROFESSIONAL PLUS STANDARD

Sicherungsringzangen

Circlip Pliers



Art.-Nr./Art.-No.	Größe/Size		
4683-A2	A2	19 - 60 mm	für Außenringe, gerade
4683-A21	A21	19 - 60 mm	für Außenringe, gebogen
4683-J2	J2	19 - 60 mm	für Innenringe, gerade
4683-J21	J21	19 - 60 mm	für Innenringe, gebogen

PROFESSIONAL PLUS STANDARD

Sicherungsringzangen

Circlip Pliers



Art.-Nr./Art.-No.	Größe/Size		
4383-A1	A1	10 - 25 mm	für Außenringe, gerade
4383-A11	A11	10 - 25 mm	für Außenringe, gebogen
4383-A2	A2	19 - 60 mm	für Außenringe, gerade
4383-A21	A21	19 - 60 mm	für Außenringe, gebogen
4383-A3	A3	40 - 100 mm	für Außenringe, gerade
4383-A31	A31	40 - 100 mm	für Außenringe, gebogen
4383-J1	J1	12 - 25 mm	für Innenringe, gerade
4383-J11	J11	12 - 25 mm	für Innenringe, gebogen
4383-J2	J2	19 - 60 mm	für Innenringe, gerade
4383-J21	J21	19 - 60 mm	für Innenringe, gebogen
4383-J3	J3	40 - 100 mm	für Innenringe, gerade
4383-J31	J31	40 - 100 mm	für Innenringe, gebogen

Blech-/Figurenscheren, Mattenschneider, Bolzenschneider

Tinmans Shears, Mesh Cutter, Bolt Cutter

Art.-Gruppen 150/155
Article Groups 150/155

PROFESSIONAL PLUS STANDARD

Blech-/Figurenscheren

Schnittleistung: Stahlblech bis 1,2 mm

Tinmans Shears

Cutting Capacity: Sheet Steel 1,2 mm

Art.-Nr./Art.-No.

4584	Satz 3-tlg./pcs links/rechts/gerade
4550	rot/links
4551	grün/rechts
4552	gelb/gerade



PROFESSIONAL PLUS STANDARD

Mattenschneider

Mesh Cutter

Spezial Mattenschneider

zum Schneiden von Baustahlgeweben

Mesh Cutter



Art.-Nr./Art.-No.	L/L	max. Schneid-Ø bei 750 N/mm ²	max. Schneid-Ø bei 1250 N/mm ²
4555	900 mm	12 mm	10 mm

PROFESSIONAL PLUS STANDARD

Bolzenschneider

Bolt Cutter

Bolzenschneider

Verschraubte, auswechselbare Köpfe
geschmiedete Backen aus Chrom-Molybdän-Stahl

Bolt Cutter



Art.-Nr./Art.-No.	Größe/Size	L/L	Weich Mat. max/Soft Mat. Max	Hart Mat. max/Hart Mat. Max
4553-14	14"	350 mm	6 mm	5 mm
4553-18	18"	450 mm	7 mm	6 mm
4553-24	24"	600 mm	10 mm	8 mm
4553-30	30"	750 mm	13 mm	10 mm
4553-36	36"	900 mm	16 mm	12 mm
4554-14	14"	Ersatz-Schneidkopf		
4554-18	18"	Ersatz-Schneidkopf		
4554-24	24"	Ersatz-Schneidkopf		
4554-30	30"	Ersatz-Schneidkopf		
4554-36	36"	Ersatz-Schneidkopf		

Gripzangen

Self Grip Pliers

Art-Gruppe 150
Article Group 150

PROFESSIONAL PLUS STANDARD

Gripzangen

glanzvernickelt, mit Lösehebel und gebogenen Backen

Self Grip Pliers

Art.-Nr./Art.-No.	Größe/Size	L/L	Spannweite/Capacity
4556-175	7"	175 mm	41 mm
4556-250	10"	250 mm	48 mm



PROFESSIONAL PLUS STANDARD

Breitmaul-Gripzangen

Self Grip Plier With Wide Jaws

Besonders breite und flache Greifbacken mit Lösehebel, geeignet zum Halten, Biegen und Bördeln von Blechen

Special width and flat self grip pliers with quick release lever, useful for fixing, bending and beading of sheets and plates

Art.-Nr./Art.-No.	Größe/Size	L/L	Spannweite/Capacity
4561-205	8"	205 mm	60 mm
4561-245	10"	245 mm	67 mm



PROFESSIONAL PLUS STANDARD

Schweißer-Gripzange

Welding Self Grip Plier



U-Form-Greifbacken, obere Greifbacke 90° abgewinkelt, zum Spannen beim Verschweißen von Profil- oder Flachmaterial, usw. auf Stoß

U-form-grip, top grip 90° offset, for clamping the welding of profile or flat material, etc. on strike

Art.-Nr./Art.-No.	Größe/Size	L/L	Spannweite/Capacity
4562-225	9"	225 mm	45 mm

PROFESSIONAL PLUS STANDARD

Klammer-Gripzange

Welding-Clip Self Grip Plier



Schmale Greifbacken mit hohem Bügel, tief ausladend, geeignet zum Spannen von Profil-Material mit hohen Stegen oder über sperrige Werkstücke

Narrow gripping jaws with high temple, deep overhangs, suitable for clamping profile material with high piers or bulky workpieces

Art.-Nr./Art.-No.	Größe/Size	L/L	Spannweite/Capacity
4563-275	11"	280 mm	73 mm

Langbeck Klemmzangen, Elektronik Zangen

Self Grip Pliers, Electronic Pliers

Art.-Gruppe 150
Article Group 150

Langbeck Klemmzange

glanzvernickelt, mit Lösehebel und geraden, langen Backen

Self Grip Pliers, Long Jaws

Art.-Nr./Art.-No.	Größe/Size	L/L	Spannweite/Capacity
4557-150	6"	150 mm	44,5 mm



Elektronik Zangen

Electronic Pliers

Elektronik Zangen

Spezial-Serie für extrem feines Arbeiten auf engstem Raum und an schwer zugänglichen Stellen.

Electronic Pliers

Special line for extremely precise working in smallest spaces and in positions otherwise inaccessible.



Art.-Nr./Art.-No.	Größe/Size	Typ/Model
4330-130	130 mm	Flachzange



Art.-Nr./Art.-No.	Größe/Size	Typ/Model
4331-120	130 mm	Rundzange



Art.-Nr./Art.-No.	Größe/Size	Typ/Model
4332-130	130 mm	Kettenzange



Art.-Nr./Art.-No.	Größe/Size	Typ/Model
4333-120	130 mm	Kettenzange 45°



Art.-Nr./Art.-No.	Größe/Size	Typ/Model
4334-110	110 mm	Seitenschneider

Zangen-Sätze

Pliers Sets

Art.-Gruppe 155
Article Group 155

4680

Zangen Set 3-teilig

- ▶ **Kombizange 180 mm** ▶ *Combination pliers 180 mm*
- ▶ **Seitenschneider 160 mm** ▶ *Side Cutter 160 mm*
- ▶ **Wasserpumpenzange 250 mm** ▶ *Waterpump Pliers 250 mm*

Pliers Set 3 pieces

Art.-Nr./Art.-No.

4680

3-tlg./pcs

3
tlg./pcs.



4681

Zangen Set 3-teilig

- ▶ **Kombizange 180 mm** ▶ *Combination pliers 180 mm*
- ▶ **Seitenschneider 160 mm** ▶ *Side cutter 160 mm*
- ▶ **Telefonzange 205 mm** ▶ *Long nose plier 205 mm*

Pliers Set 3 pieces

Art.-Nr./Art.-No.

4681

3-tlg./pcs

3
tlg./pcs.



Zangen Set VDE 3-teilig

Pliers Set VDE 3 pieces



4691

Zangen Set VDE 3-teilig VDE/EN 60900

- ▶ **Kombizange 180 mm** ▶ *Combination pliers 180 mm*
- ▶ **Seitenschneider 160 mm** ▶ *Side Cutter 160 mm*
- ▶ **Telefonzange 205 mm** ▶ *Long nose pliers 205 mm*

Pliers Set VDE 3 pieces

VDE/EN 60900

Art.-Nr./Art.-No.

4691

3-tlg./pcs

3
tlg./pcs.



Zangen-Sätze

Pliers Sets

Art.-Gruppen 150/155
Article Groups 150/155

PROFESSIONAL PLUS STANDARD

4683

Sicherungsringzangen Satz, 4-teilig

Circlip Pliers Set, 4 pieces

4
tlg./pcs.

Art.-Nr./Art.-No.

4683 A2 - A21 - J2 - J21

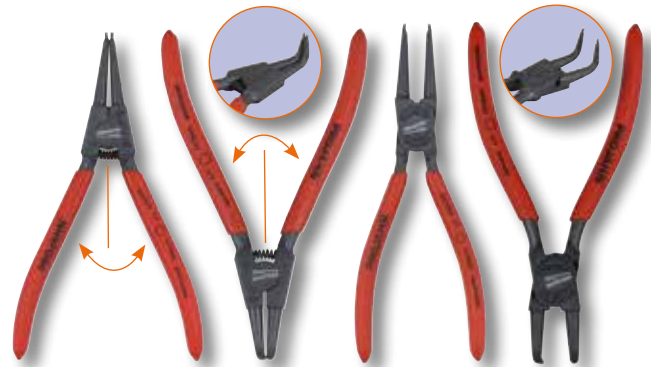

PROFESSIONAL PLUS STANDARD

4383

Sicherungsringzangen Satz, 4-teilig

Circlip Pliers Set, 4 pieces

4
tlg./pcs.

Art.-Nr./Art.-No.

4383 A2 - A21 - J2 - J21

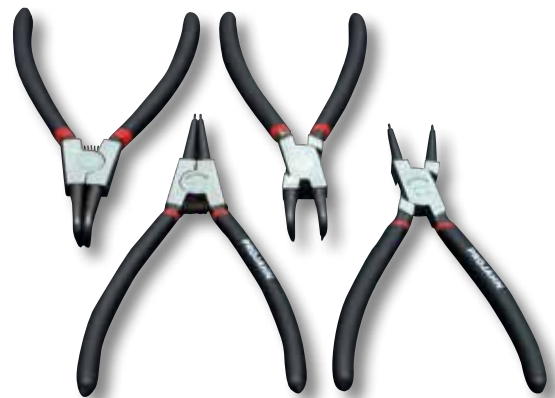

PROFESSIONAL PLUS STANDARD

Blech-/Figurenscheren Satz, 3-teilig

Tinmans Shears Set, 3 pieces

4584

Blech-/Figurenscheren Satz 3-teilig
Schnittleistung: Stahlblech bis 1,2 mm

Tinmans shears set 3 pieces

Cutting capacity: sheet steel 1,2 mm

3
tlg./pcs.

Art.-Nr./Art.-No.

4584 Satz 3-tlg./pcs links/rechts/gerade



Taschenlampen & Arbeitsleuchten

Flashlights & Working Lamps



Power-LED-Taschenlampen & Arbeitsleuchten

Power LED Flashlights and Working Lamps

PROLUMAX



398211

- ▶ **Neueste LED-Technologie**
 - Hohe Lichtleistung + Helligkeit, große Leuchtwerte, nahezu weißes Licht
 - Lange LED-Lebensdauer
 - 10 Jahre Funktionsgarantie auf alle PROLumax-Leuchten mit Cree®, SMD®- und COB®-LED-Technologie
- ▶ **Hochwertige Verarbeitung & Materialien**
 - Aus robustem, langlebigem und stoßfestem Flugzeugaluminium
 - Spritzwasserdicht nach IP54
- ▶ **Schlankes und modernes Design verknüpft mit durchdachten Mehrwerten**
 - Kein unnötiger Ballast und ausgeglichenes Handling
 - Sowohl mit handelsüblichen Batterien als auch mit Standardakkus funktionsfähig
 - Wiederaufladbare Lithium-Ionen-Akkus (bei Modellen 398250, 398251)
 - Ergonomische, rutschhemmende Oberfläche
- ▶ **Innovative Funktionen**
 - Mit Handschuh bedienbarer Schalter, zusätzlich Wegrollschutz
 - 2 Lichtleistungen über Schalter wählbar bzw. stufenlos dimmbar (nicht bei Art.-Nr. 398210/398213/398214)
 - Variabler Leuchtwinkel durch fokussierbare Linse (nicht bei Art.-Nr. 398213/398214/398215)

- ▶ **Latest LED technology**
 - High luminous power + brightness, extensive light distance, almost white light
 - Long life LED
 - 10 year life guarantee on all PROLumax-flashlights with Cree®, SMD®- and COB®-LED-technology
- ▶ **High-quality workmanship & materials**
 - Made of sturdy, durable and impact-resistant aircraft aluminium
 - Impermeable to splash-water by IP54
- ▶ **Slim and modern design associated with sophisticated added values**
 - No dead weight and easy handling
 - Usable with standard batteries as well as with rechargeable batteries
 - Rechargeable Lithium-Ion batteries (398250, 398251)
 - Ergonomic, non slip surface
- ▶ **Innovative Features**
 - Easily operable with gloves
 - 2 light power levels selectable or continuously dimmable (not for Art.-No. 398210/398213/398214)
 - Roll away protection
 - Variable angle of illumination by focusable lens (not for Art.-No. 398213/398214/398215)

* Alle Werte gemessen entsprechend ANSI FL1-Prüfverfahren
 * All data scaled according to ANSI FL1-method of test



Einkerbungen verhindern Wegrollen /
 Roll away protection

Extrem griffsicher durch rutschfeste Rändelung /
 Extremely secure grip due to non-slip knurling



Aus Flugzeugaluminium – stoßfest aus 1,5 m Höhe /
 Made of aircraft aluminium – durable + impact resistant



Variabler Leuchtwinkel durch fokussierbare Linse /
 Variable angle of illumination by focusable lens

Zwei Lichtleistungen wählbar / Two Light Power Levels selectable



Ein/Aus-Knopf /
 On/Off Switch

Kein ungewolltes Ein/Ausschalten, durch tief liegenden Ein/Aus-Knopf. Selbst mit Handschuhen bedienbar! /
 Backside switch, easily operable even with gloves!

Power-LED-Taschenlampen & Arbeitsleuchten

Power LED Flashlights and Working Lamps

Art.-Gruppen 184
Article Groups 184

398215

PROLumax Cree®-Power LED-Taschenlampe PJ 500 PROLumax Cree® Power LED Flashlight PJ 500



stufenlos dimmbar /
continuously dimmable

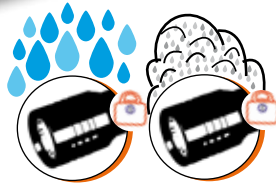

Cree®-Power LED-Taschenlampe PJ 500

Technische Daten / Technical Details:

Leuchtmittel/Illuminant:	10 Watt CREE® CM-L2 T6 Power-LED
Leuchtdauer/Fluorescent time:	ca. 8 Stunden/hours*
Lichtleistung/Light Power:	500 Lumen*
Leuchtweite/Light Distance:	300 Meter*
Material/Material:	Aluminium, eloxiert
Gewicht/Weight:	225 Gramm
Batterien/Batteries:	3x C-Cell (inklusive)

- ▶ 10 Jahre Funktionsgarantie auf LED/
10 year functional guarantee on LED
- ▶ IP 67 = wasser- und staubdicht,
über Ein-/Ausschalter stufenlos dimmbar/
IP 67 = water and dust proof,
continuously dimmable

Art.-Nr./Art.-No.	Modell/Model	Farbe/Color	Länge/Length	Ø
398215	PJ500	Schwarz/Black	236 mm	42 mm

398211

PROLumax Cree®-Power LED-Taschenlampe PJ 120 PROLumax Cree® Power LED Flashlight PJ 120



Cree®-Power LED-Stiftlampe PJ 120

Technische Daten / Technical Details:

Leuchtmittel/Illuminant:	3 Watt CREE® white XP-E LED
Leuchtdauer/Fluorescent time:	ca. 2,5 Stunden/hours*
Lichtleistung/Light Power:	120 Lumen*
Leuchtweite/Light Distance:	65 Meter*
Material/Material:	Aluminium, eloxiert
Gewicht/Weight:	85 Gramm
Batterien/Batteries:	2x AA (inklusive)

- ▶ 10 Jahre Funktionsgarantie auf LED/
10 year functional guarantee on LED
- ▶ Fokussierbare Linse, zwei Lichtleistungen/
Focusable lens, two light power levels

Art.-Nr./Art.-No.	Modell/Model	Farbe/Color	Länge/Length	Ø
398211	PJ120	Schwarz/Black	151 mm	29 mm

398212

PROLumax Cree®-Power LED-Taschenlampe PJ 220 PROLumax Cree® Power LED Flashlight PJ 220



Cree®-Power LED-Stiftlampe PJ 220

Technische Daten / Technical Details:

Leuchtmittel/Illuminant:	5 Watt CREE® XP-G R5 Power-LED
Leuchtdauer/Fluorescent time:	ca. 1,5 Stunden/hours*
Lichtleistung/Light Power:	220 Lumen*
Leuchtweite/Light Distance:	130 Meter*
Material/Material:	Aluminium, eloxiert
Gewicht/Weight:	171 Gramm
Batterien/Batteries:	3x AAA (inklusive)

- ▶ 10 Jahre Funktionsgarantie auf LED/
10 year functional guarantee on LED
- ▶ Fokussierbare Linse, zwei Lichtleistungen/
Focusable lens, two light power levels

Art.-Nr./Art.-No.	Modell/Model	Farbe/Color	Länge/Length	Ø
398212	PJ220	Schwarz/Black	138 mm	41 mm

* Alle Werte gemessen entsprechend ANSI FL1-Prüfverfahren / All data scaled according to ANSI FL1-method of test

Power-LED-Taschenlampen & Arbeitsleuchten

Power LED Flashlights and Working Lamps

Art.-Gruppen 184
Article Groups 184

398210

PROFESSIONAL PLUS STANDARD

PROLumax Cree®-Power-LED-Taschenlampe PJ45

PROLumax Cree® Power LED Flashlight PJ45



Cree®-Power LED-Taschenlampe PJ45

Technische Daten / Technical Details:

Leuchtmittel/Illuminant:	3 Watt CREE® white XPE LED
Leuchtdauer/Fluorescent time:	ca. 6 Stunden/hours*
Lichtleistung/Light Power:	45 Lumen*
Leuchtweite/Light Distance:	45 Meter*
Material/Material:	Aluminium, eloxiert
Gewicht/Weight:	51 Gramm
Batterien/Batteries:	1x AA (inklusive)

- ▶ 10 Jahre Funktionsgarantie auf LED/
10 year functional guarantee on LED
- ▶ Fokussierbare Linse, leicht und handlich/
Focusable lens, light weight and handy size

Art.-Nr./Art.-No.	Modell/Model	Farbe/Color	Länge/Length	Ø
398210	PJ45	Schwarz/Black	99 mm	25 mm

398213GB

PROFESSIONAL PLUS STANDARD

PROLumax Power-LED-Stiftlampe PJ15

PROLumax Power LED Penlight PJ15



Power-LED-Stiftlampe PJ15

Technische Daten / Technical Details:

Leuchtmittel/Illuminant:	0,5 Watt Power-LED
Leuchtdauer/Fluorescent time:	ca. 4 Stunden/hours*
Lichtleistung/Light Power:	15 Lumen*
Leuchtweite/Light Distance:	13 Meter*
Material/Material:	Aluminium, eloxiert
Gewicht/Weight:	31 Gramm
Batterien/Batteries:	1x AAA (inklusive)

- ▶ Mit Karabinerhaken ideal für den Schlüsselbund/
With carabiner fits perfect to your bunch of keys



Art.-Nr./Art.-No.	Modell/Model	Farbe/Color	Länge/Length	Ø
398213GB	PJ15	Schwarz/Black	95 mm	17 mm
39821314D	Display mit 9 x 398213 und 9 x 398214			

398214GB

PROFESSIONAL PLUS STANDARD

PROLumax Power-LED-Stiftlampe PJ23

PROLumax Power LED Penlight PJ23



Power-LED-Stiftlampe PJ23

Technische Daten / Technical Details:

Leuchtmittel/Illuminant:	0,5 Watt Power-LED
Leuchtdauer/Fluorescent time:	ca. 4 Stunden/hours*
Lichtleistung/Light Power:	23 Lumen*
Leuchtweite/Light Distance:	16 Meter*
Material/Material:	Aluminium, eloxiert
Gewicht/Weight:	36 Gramm
Batterien/Batteries:	2x AAA (inklusive)

- ▶ Mit Halteclip ideal für Jacken- oder Westentasche/
With clip perfect for your waist coat pocket



Art.-Nr./Art.-No.	Modell/Model	Farbe/Color	Länge/Length	Ø
398214GB	PJ23	Schwarz/Black	139 mm	17 mm
39821314D	Display mit 9 x 398214 und 9 x 398213			

Power-LED-Taschenlampen & Arbeitsleuchten

Power LED Flashlights and Working Lamps

Art.-Gruppen 182
Article Groups 182

398231

PROLumax Cree®-Power LED-Universal-Spotlight PJ100 UNI

PROLumax Cree® Power LED Universal Spotlight PJ100 UNI



Cree®-Power LED Taschenlampe PJ100 UNI

NEU/NEW

Technische Daten / Technical Details:

Leuchtmittel/Illuminant:	3 W CREE® XP-E2 LED
Leuchtdauer/Fluorescent time:	ok. 3 Stunden/hours*
Lichtleistung/Light Power:	100 Lumen*
Leuchtweite/Light Distance:	90 Meter*
Material/Material:	Aluminium, eloxiert
Gewicht/Weight:	66 Gramm
Batterien/Batteries:	1x AAA (inklusive)
Spritzwasserdicht IPX4/Splashproof IPX4	

- ▶ 10 Jahre Funktionsgarantie auf LED/
10 year functional guarantee on LED
- ▶ Fokussierbare Linse, leicht und handlich/
Focusable lens, light weight and handy size

Art.-Nr./Art.-No.	Modell/Model	Farbe/Color	Länge/Length	Ø
398231	PJ100UNI	Schwarz/Black	99 mm	25 mm

398230

PROLumax Cree®-Power LED-Stirnlampe PJ 100S

PROLumax Cree® Power LED Headlamp PJ 100S



Cree®-Power LED-Stirnlampe PJ 100S

Technische Daten / Technical Details:

Leuchtmittel/Illuminant:	1x 3 Watt CREE® XP-E LED 1x Standard-LED (weiß) 2x Standard-LED (rot)
Leuchtdauer/Fluorescent time:	ca. 6 Stunden/hours*
Lichtleistung/Light Power:	100 Lumen*
Leuchtweite/Light Distance:	50 Meter*
Material/Material:	Kunststoff/plastic
Gewicht/Weight:	140 Gramm
Batterien/Batteries:	3x AAA (inklusive)

- ▶ 10 Jahre Funktionsgarantie auf LED/
10 year functional guarantee on LED
- ▶ Hoher Tragekomfort,
2 Lichtleistungen und 3 Leucht-/Blinkmodi einstellbar/
Greater wearing comfort,
2 light power levels and 3 light/twinking levels selectable

Art.-Nr./Art.-No.	Modell/Model	Farbe/Color
398230	PJ100S	Schwarz/Black

398251

PROLumax LED-Arbeitslampe PJ-AL 150

PROLumax LED Working Lamp PJ-AL 150



Power-LED-Arbeitslampe PJ-AL 150

Technische Daten / Technical Details:

Leuchtmittel/Illuminant:	1x 1,5 Watt COB-Power-LED
Leuchtdauer/Fluorescent time:	ca. 5 Stunden/hours*
Ladedauer/Charging Periode:	ca. 4 Stunden/hours
Material/Material:	Kunststoff/plastic
Gewicht/Weight:	165 Gramm
Lichtleistung/Light Power:	150 Lumen*
Leuchtwinkel/Light Angle:	120°
Akku/Battery:	Lithium-Ionen-Akku, wieder aufladbar/ rechargeable lithium ions battery
Kapazität/Capacity:	1.800 mAh
Inkl. 110 - 240 V Netzteil und Kfz-Ladekabel/ Incl. 110 - 240 V Power Unit and Car Charger	

- ▶ 10 Jahre Funktionsgarantie auf LED/ 10 year functional guarantee on LED
- ▶ Extrem schlanke Bauform, rückseitiger Magnet/
Extremely slim design, back side with magnetic area
- ▶ Wiederaufladbarer Lithium-Ionen-Akku/Rechargeable lithium ions battery
- ▶ Rutschfeste Oberfläche/Non-slip surface

Art.-Nr./Art.-No.	Modell/Model	Farbe/Color	Maße/Dimensions
398251	PJ-AL 150	Schwarz/Black	13 x 45 x 320 mm

Power-LED-Taschenlampen & Arbeitsleuchten

Power LED Flashlights and Working Lamps

Art.-Gruppen 184
Article Groups 184

398250

PROLumax LED-Hand-Arbeitslampe PJ-AL 120

PROLumax LED Hand Working Lamp PJ-AL 120



Als Powerbank nutzbar

Power-LED-Hand-Arbeitslampe PJ-AL 120

Technische Daten / Technical Details:

Leuchtmittel/Illuminant: 4x 0,5 Watt SMD-Power-LED
 Leuchtdauer/Fluorescent time: ca. 3 Stunden/hours*
 Lichtleistung/Light Power: 120 Lumen*
 Leuchtwinkel/Light Angle: 100°
 Ladedauer/Charging Periode: ca. 4 Stunden/hours
 Material/Material: Kunststoff/plastic
 Gewicht/Weight: 150 Gramm
 Akku/Battery: Lithium-Ionen-Akku, wiederaufladbar/
 rechargeable lithium ions battery
 Kapazität/Capacity: 1.800 mAh
 Inkl. 110 - 240 V Netzteil und Kfz-Ladekabel/
 Incl. 110 - 240 V Power Unit and Car Charger

- ▶ 10 Jahre Funktionsgarantie auf LED/
10 year functional guarantee on LED
- ▶ Als Powerbank nutzbar, integrierter Kippfuß mit Magnet/
Usable as Powerbank, integrated tilt food with magnet
- ▶ Wiederaufladbarer Lithium-Ionen-Akku/
Rechargeable lithium ions battery
- ▶ Rutschfeste, ergonomische Oberfläche/
Non-slip surface

Art.-Nr./Art.-No.	Modell/Model	Farbe/Color	Maße/Dimensions
398250	PJ-AL120	Schwarz/Black	60 x 25 x 120 mm

*Praxisbeispiel. Mobiltelefon nicht im Lieferumfang enthalten.

398252

PROLumax Power LED-Werkstattlampe PJ-AL250

PROLumax Power LED Workshop Lamp PJ-AL250

NEU/NEW



Geknickt

Haken

Hinten

Zweit-LED

Zubehör

Power-LED-Werkstattlampe PJ-AL250

Technische Daten / Technical Details:

Leuchtmittel/Illuminant: 6x 0,5 W SMD-Power-LED
 1x Standard-LED (weiß/white)
 Leuchtdauer/Fluorescent time: ca. 3 Stunden/hours*
 Lichtleistung/Light Power: 250 Lumen*
 Leuchtwinkel/Light Angle: 100°
 Leuchtweite/Light Distance: 7 Meter*
 Ladedauer/Charging Periode: ca. 4 Stunden/hours
 Material/Material: Kunststoff/plastic
 Gewicht/Weight: 315 Gramm
 Akku/Battery: Lithium-Ionen-Akku, wiederaufladbar/
 rechargeable lithium ions battery
 Kapazität/Capacity: 2.200 mAh
 Inkl. 110 - 240 V Netzteil und Kfz-Ladekabel/
 Incl. 110 - 240 V Power Unit and Car Charger

- ▶ 10 Jahre Funktionsgarantie auf LED/
10 year functional guarantee on LED
- ▶ Wiederaufladbarer Lithium-Ionen-Akku/
Rechargeable lithium ions battery
- ▶ Rutschfeste, ergonomische Oberfläche/
Non-slip surface
- ▶ Integrierter Schwenkfuß mit Magnet/
10 year functional guarantee on LED

Art.-Nr./Art.-No.	Modell/Model	Farbe/Color	Maße/Dimensions
398252	PJ-AL250	Schwarz/Black	65 x 45 x 275 mm

* Alle Werte gemessen entsprechend ANSI FL1-Prüfverfahren / All data scaled according to ANSI FL1-method of test

Sonstige Werkzeuge

Other Tools



Hämmer und Stemmeisen

Hammer and Wood Chisel Sets

Art.-Gruppen 160/182
Article Groups 160/182

PROFESSIONAL PLUS STANDARD

Schlosserhämmer mit Stielschutz

Machinist Hammer with Protection



Art.-Nr./Art.-No.	Größe/Size
2363	300 g
2365	500 g
2368	800 g
2369	1.000 g

Schlosserhämmer

Machinist Hammer



Art.-Nr./Art.-No.	Größe/Size
2301	100 g
2302	200 g
2303	300 g
2304	400 g
2305	500 g
2308	800 g
2310	1.000 g
2315	1.500 g

Latthammer

Roofing Hammer



Art.-Nr./Art.-No.	Größe/Size
2321	600 g

- ▶ Mit Nagelmagnet zum Halten der Nägel
- ▶ With magnet for nails

Handfäustel

Stoning Hammer



Art.-Nr./Art.-No.	Größe/Size
2325	1.000 g
2324	1.250 g
2326	1.500 g

Kunststoffhammer

Dead-Blow Hammer



Art.-Nr./Art.-No.	Größe/Size
2341	Ø 35 mm
2341-1	Ersatzkopf schwarz/ Hammer Head black
2341-2	Ersatzkopf gelb/ Hammer Head yellow

PROFESSIONAL PLUS STANDARD

Stemmeisen Sätze

NEU/NEW

Wood Chisel Sets

- 4 tlg./pcs.
- 5 tlg./pcs.
- 6 tlg./pcs.



Art-Nr. 3362

Art.-Nr./Art.-No.	Größe/Size
3361	12 - 16 - 20 - 24 mm, 4-tlg.
3363	6 - 12 - 16 - 20 - 25 mm, 5-tlg.
3362	6 - 10 - 14 - 18 - 22 - 26 mm, 6-tlg.

Splintentreiber, Durchschläge und Meißel

Pin Punches, Taper Punches and Chisels

Art.-Gruppe 160
Article Group 160

Splintentreiber-, Durchschlag- und Meißelsätze

Pin Punches, Taper Punches and Chisels



Art.-Nr./Art.-No.	Teile/pieces	Größe/Size	
3350	6	2-3-4-5-6-8 mm	Splintentreiber/Pin Punch
3355	5	2-3-4-5-6 mm	Durchschlag/Taper Punch
3370	5	Splintentreiber 4 mm, Durchschlag 3 mm, Körner Nr. 2, Kreuzmeißel 5 x 130 mm, 8-kant Flachmeißel 12 x 130 mm	

Einzelteile

Single Parts



Art.-Nr./Art.-No.	Größe/Size	Länge/Length	
3350-2	2 mm	115 mm	Splintentreiber/Pin Punch
3350-3	3 mm	125 mm	Splintentreiber/Pin Punch
3350-4	4 mm	150 mm	Splintentreiber/Pin Punch
3350-5	5 mm	165 mm	Splintentreiber/Pin Punch
3350-6	6 mm	180 mm	Splintentreiber/Pin Punch
3350-8	8 mm	180 mm	Splintentreiber/Pin Punch
3355-2	2 mm	120 mm	Durchschlag/Taper Punch
3355-3	3 mm	120 mm	Durchschlag/Taper Punch
3355-4	4 mm	120 mm	Durchschlag/Taper Punch
3355-5	5 mm	120 mm	Durchschlag/Taper Punch
3355-6	6 mm	120 mm	Durchschlag/Taper Punch
3370-1	Nr. 2	120 mm	Körner/Center Punch
3370-2	5 mm	130 mm	Kreuzmeißel/Cross Chisel
3370-3	12 mm	130 mm	8-kant Flachmeißel/Flat Chisel, 8-flank



Art.-Nr./Art.-No.	Größe/Size	Länge/Length	
3371-1	16 mm	200 mm	8-kant Spitzmeißel/Pointed Chisel, 8-flank
3371-2	16 mm	200 mm	8-kant Flachmeißel/Flat Chisel, 8-flank

Sanitärwerkzeuge

Sanitary Tools

Art.-Gruppe 190
Article Group 190

Rohrabschneider Mini Mini Tube Cutter



Rohrabschneider KOMPAKT Mini Mini Tube Cutter KOMPAKT



Rohrabschneider Tube Cutter



- **Zum Schneiden von Aluminium, Kupfer und dünnwandigen Stahlrohren**
- For cutting aluminum, copper, and thin-walled steel tubes

Art.-Nr./Art.-No.	Größe/Size
396202	3 – 25 mm
6299-01	Ersatzrädchen 19 x 5 für AL, Cu, INOX
6299-07	Ersatzrädchen 22 x 5 für Plastik

Art.-Nr./Art.-No.	Größe/Size
6211	3 – 30 mm
6299-01	Ersatzrädchen 19 x 5 für AL, Cu, INOX
6299-07	Ersatzrädchen 22 x 5 für Plastik

Art.-Nr./Art.-No.	Größe/Size
396205	3 – 35 mm
6299-01	Ersatzrädchen 19 x 5 für AL, Cu, INOX
6299-07	Ersatzrädchen 22 x 5 für Plastik

Rohrabschneider mit Entgrater Telescopic Tube Cutter with Deburrer



Rohrabschneider KOMPAKT mit Entgrater Telescopic Tube Cutter KOMPAKT with Deburrer



Rohrabschneider KOMPAKT QUICK mit Entgrater Telescopic Tube Cutter KOMPAKT QUICK with Deburrer



- **Zum Schneiden von Aluminium, Kupfer und dünnwandigen Stahlrohren, inkl. 1 Ersatzrädchen im Drehknopf, mit 4 Führungsrollen für einen optimalen Halt des Rohres beim Schneiden, Schneidrädchen-Wechsel ohne Werkzeug**
- **Artikel 396212 + 396213 mit integrierter NOGA-Entgraterklinge** ► **Artikel 6214 mit Schnellvorschub**
- For cutting aluminum, copper, and thin-walled steel tubes, incl. 1 cutting wheel in rotary handle, with 4 rollers for optimum support of the pipe during cutting, cutting wheel changing without tools
- Article 396212 + 396213 with integrated NOGA deburring blade ► Article 6214 with fast feed

Art.-Nr./Art.-No.	Größe/Size
396212	3 – 35 mm
6299-01	Ersatzrädchen 19 x 5 für AL, Cu, INOX
6299-07	Ersatzrädchen 22 x 5 für Plastik

Art.-Nr./Art.-No.	Größe/Size
396213	3 – 45 mm
6299-01	Ersatzrädchen 19 x 5 für AL, Cu, INOX
6299-07	Ersatzrädchen 22 x 5 für Plastik

Art.-Nr./Art.-No.	Größe/Size
6214	6 – 67 mm
6299-05	Ersatzrädchen 19 x 6,2 für AL, Cu, INOX

Sanitärwerkzeuge

Sanitary Tools

Art.-Gruppe 190
Article Group 190

Rohrabschneider KOMPAKT PT QUICK

Tube Cutter KOMPAKT PT QUICK



- ▶ **Zum Schneiden von Kunststoff und Verbundrohren, inkl. 1 Ersatzrädchen im Drehknopf mit 4 Führungsrollen für einen optimalen Halt des Rohres beim Schneiden, Schneidrädchen-Wechsel ohne Werkzeug**
- ▶ *For cutting plastic tubes, incl. 1 cutting wheel in rotary handle, with 4 rollers for optimum support of the pipe during cutting, cutting wheel changing without tools*

Art.-Nr./Art.-No.	Größe/Size
6215	6 – 67 mm
6299-06	Ersatzrädchen 26 x 6,2 für Kunststoff- und Verbundrohre

Rohrabschneider für Stahlrohre

Tube Cutter for Steel Tubes



- ▶ **Zum Schneiden von Stahl- und INOX-Rohren – das Federandruck-System garantiert verbesserten Schnitt und längere Lebensdauer des Schneidrädchens**
- ▶ *For cutting steel- and INOX tubes – a special system ensures improved cutting and longer life of the cutting wheel*

Art.-Nr./Art.-No.	Größe/Size
6216	10 – 60 mm (1/8" – 2")
6299-02	Ersatzrädchen 31 x 19 für Stahl und INOX

Rohrabschneider INOX Mini

Mini Tube Cutter INOX



Rohrabschneider INOX KOMPAKT mit Entgrater

Tube Cutter INOX KOMPAKT with Deburrer



Rohrabschneider INOX KOMPAKT mit Entgrater

Tube Cutter INOX KOMPAKT with Deburrer



- ▶ **Zum Schneiden von Aluminium, Kupfer und dünnwandigen Stahlrohren (speziell für V2A-/INOX-Rohre geeignet), inkl. 1 Ersatzrädchen im Drehknopf, Schneidrädchen-Wechsel ohne Werkzeug, Artikel 396222 + 396223 mit 4 Führungsrollen für einen optimalen Halt des Rohres beim Schneiden und integrierter NOGA-Entgraterklinge**
- ▶ *For cutting aluminum, copper, and thin-walled steel tubes (especially for V2A-/INOX tubes), incl. 1 cutting wheel in rotary handle, cutting wheel changing without tools, article 396222 + 396223 with 4 rollers for optimum support of the pipe during cutting and integrated NOGA deburring blade*

Art.-Nr./Art.-No.	Größe/Size
396221	3 – 30 mm
396297-01	Ersatzrädchen 19 x 5 für INOX/V2A

Art.-Nr./Art.-No.	Größe/Size
396222	3 – 35 mm
396297-01	Ersatzrädchen 19 x 5 für INOX/V2A

Art.-Nr./Art.-No.	Größe/Size
396223	3 – 45 mm
396297-01	Ersatzrädchen 19 x 5 für INOX/V2A

Sanitärwerkzeuge

Sanitary Tools

Art.-Gruppe 190
Article Group 190

Rohrabschneider INOX KOMPAKT QUICK

Tube Cutter INOX KOMPAKT QUICK



Art.-Nr./Art.-No.	Größe/Size
396224	6 – 67 mm
396297-05	Ersatzrädchen 19 x 6,2 für V2A/INOX

- ▶ Zum Schneiden von Aluminium, Kupfer und dünnwandigen Stahlrohren (speziell für V2A-/INOX-Rohre geeignet), inkl. 1 Ersatzrädchen im Drehknopf, Schneidrädchen-Wechsel ohne Werkzeug, mit 4 Führungsrollen für einen optimalen Halt des Rohres beim Schneiden und Schnellvorschub
- ▶ For cutting aluminum, copper, and thin-walled steel tubes (especially for V2A-/INOX tubes), incl. 1 cutting wheel in rotary handle, cutting wheel changing without tools, with 4 rollers for optimum support of the pipe during cutting and fast feed

Rohrabschneider Satz

Tube Cutter Set

2
tlg./pcs.



Art.-Nr./Art.-No.	Größe/Size
9986	KOMPAKT Mini 3 – 30 mm + KOMPAKT 3 – 45 mm

- ▶ Zum Schneiden von Aluminium, Kupfer und dünnwandigen Stahlrohren
- ▶ For cutting aluminum, copper and thin-walled steel tubes

Bestehend aus Artikel 6211 + 396213
Content item 6211 + 396213

Wasserhahnventil-Sitzfräser

Water Tap Milling Cutter



Fräse

Milling Cutter

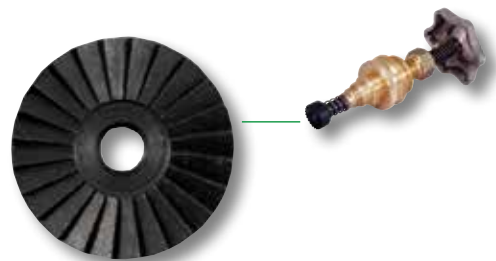

- ▶ inkl. 4 Fräser (3/8" – 1/2" – 3/4" – 1")
- ▶ incl. 4 Milling Cutter (3/8" – 1/2" – 3/4" – 1")

Art.-Nr./Art.-No.	Größe/Size
6271	3/8" – 1" (14 – 28 mm)

Art.-Nr./Art.-No.	Größe/Size
6271-10	1/8" (10 mm)
6271-12	1/4" (12 mm)
6271-14	3/8" (14 mm)
6271-17	1/2" (17 mm)
6271-20	5/8" (20 mm)
6271-24	3/4" (24 mm)
6271-28	1" (28 mm)

Sanitärwerkzeuge

Sanitary Tools

Art.-Gruppe 190
Article Group 190

PROFESSIONAL PLUS STANDARD

Kunststoff-Rohrschere

Plastic Tube Cutter



6261-01



6261

- ▶ Zum Schneiden von Kunststoff und Verbundrohren mit optimaler Kraftübertragung
- ▶ Klingenwechsel ohne Werkzeug
- ▶ Mit INOX-Klinge 'Made in Solingen'
- ▶ Automatischer Klingen-Rückzug
- ▶ For cutting plastic tubes with optimal power transmission
- ▶ Cutting wheel changing without tools
- ▶ With INOX blade 'Made in Solingen'
- ▶ Automatic blade return

Art.-Nr./Art.-No.	Größe/Size
6261	26 mm / 1"
6261-01	Ersatz-Klinge/Blade

PROFESSIONAL PLUS STANDARD

Kunststoff-Rohrschere

Plastic Tube Cutter



6263-01



6263

- ▶ Zum Schneiden von Kunststoff und Verbundrohren mit optimaler Kraftübertragung
- ▶ Klingenwechsel ohne Werkzeug
- ▶ Mit INOX-Klinge 'Made in Solingen'
- ▶ Schnellrückzug der Klinge durch Knopfdruck
- ▶ For cutting plastic tubes with optimal power transmission
- ▶ Cutting wheel changing without tools
- ▶ With INOX blade 'Made in Solingen'
- ▶ Fast blade return by pushing the button

Art.-Nr./Art.-No.	Größe/Size
6263	42 mm / 1 5/8"
6263-01	Ersatz-Klinge/Blade

PROFESSIONAL PLUS STANDARD

Spezienschlüssel Sanitär

Sanitary Wrench



Art.-Nr./Art.-No.	Größe/Size
6252	17 x 19 mm, M10

PROFESSIONAL PLUS STANDARD

Umsteckknarren-Set für 1/2" Vierkant-Antrieb, 3-tlg.

Ratchet Handle for 1/2" Drive,
Set 3 pieces

3
tlg./pcs.

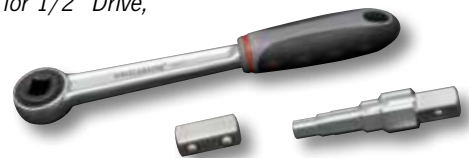

Art.-Nr./Art.-No.	Größe/Size
4297-10	1/2" Knarre/ratchet, 251 mm, 1/2" Vierkant, Stufenschlüssel 3/8", 29/64", 31/64", 21/32", 53/64"

PROFESSIONAL PLUS STANDARD

Sanitärkreuzschlüssel

Sanitary Cross Wrench



Art.-Nr./Art.-No.	Größe/Size
6253	200 x 200 mm
	10 mm - 3/8"
	12 mm - 1/2" - M8
	17 mm - 3/4" - M10
	22 mm - 1" - M12

PROFESSIONAL PLUS STANDARD

Umsteckknarre für 1/2" Vierkant-Antrieb

Ratchet Handle
for 1/2" Drive

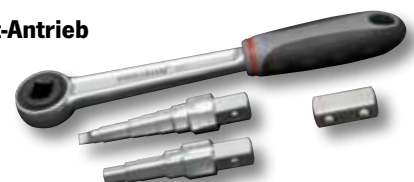

Art.-Nr./Art.-No.	Größe/Size
4297	1/2" Knarre/Ratchet, 251 mm
4297-1	1/2" Vierkant
4297-2	Stufenschlüssel, 5-stufig 3/8", 29/64", 31/64", 21/32", 53/64"
4297-3	Stufenschlüssel, 8-stufig 7/8", 27/32", 3/4", 35/64", 1/2", 15/32", 7/16", 3/8" Schraubendreher-Klinge für Schlitzschrauben

Sanitärwerkzeuge / Teleskop-Magnetheber

Sanitary Tools / Magnetic Pick Up Tools

Art.-Gruppe 190
Article Group 190

Standhahn-Mutter Schlüssel

Basin Wrench



Art.-Nr./Art.-No.	Länge/Length
6251	240 mm

Blech-Locher

**3-schneidig, Bleche bis 1,5 mm/
VA-Bleche bis 1,2 mm**

3-blade Hole Punch
Steel Sheet up to 1,5 mm/
VA-Steel Sheet up to 1,2 mm



Art.-Nr./Art.-No.	Größe/Size
6241*	32 mm
6242*	35 mm
6241-1*	Ersatz-Schraube/Screw M10 x 1

*Lieferung nur solange der Vorrat reicht / Delivery while stocks last

3196

Teleskop-Magnetheber

Magnetic Pick Up Tool



- ▶ **Bis 2 kg Hubkraft** ▶ Up to 2 kg
- ▶ **130 – 630 mm ausziehbar** ▶ 130 – 630 mm
- ▶ **Großer Dauermagnet und Clip** ▶ With big magnet

Art.-Nr./Art.-No.	Länge/Length
3196	130 - 630 mm ausziehbar

3197

2-in-1 Pick-up Magnetheber

2-in-1 Magnetic Pick Up Tool

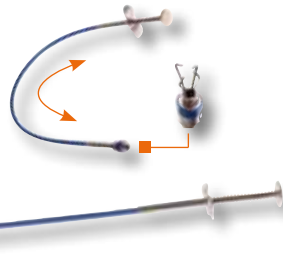

- ▶ **Heben von Kleinteilen aus Hohl- u. Zwischenräumen**
- ▶ **Hebekraft ca. 6 – 8 N, entspricht ca. 0,6 – 0,8 kg**
- ▶ **Greifer für nichtmetallische Teile**
- ▶ **Flexibel: Auch um Ecken und Kanten einsetzbar**
- ▶ Lifting small things in narrow spaces
- ▶ Lifting force ca. 6 – 8 N, according ca. 0,6 – 0,8 kg
- ▶ Picker for non-metallic things
- ▶ Flexible: Can also be used around corners and edges

Art.-Nr./Art.-No.	Länge/Length
3197	600 mm flexibel

PROFESSIONAL PLUS STANDARD

Innen- und Außen-Rohrentgrater

Inside/Outside

Tube Deburrer



- ▶ **Zum Entgraten von harten Kunststoff- + Metall-Rohren**
- ▶ **Körper aus ABS**
- ▶ **Klingen 'Made in Solingen'**
- ▶ For deburring of hard plastic + metal tubes • ABS body
- ▶ Blades 'Made in Solingen'

Art.-Nr./Art.-No.	Größe/Size
6258	3 – 42 mm

Feilen und Raspeln

Files and Rasps

Art.-Gruppe 181
Article Group 181

Raspel, flach, 200 mm

Flat Rasp, 200 mm



Art.-Nr./Art.-No.	Typ/Model
3386-2	Hieb 2 (Halbschlicht)

Raspel, halbrund, 200 mm

Half Round Rasp, 200 mm



Art.-Nr./Art.-No.	Typ/Model
3387-1	Hieb 1 (Bastard)
3387-2	Hieb 2 (Halbschlicht)
3387-3	Hieb 3 (Schlicht)

Raspel, rund, 200 mm

Round Rasp, 200 mm



Art.-Nr./Art.-No.	Typ/Model
3388-2	Hieb 2 (Halbschlicht)

Flachfeile, 200 mm

Flat File, 200 mm



Art.-Nr./Art.-No.	Typ/Model
3381-1	Hieb 1 (Bastard)
3381-2	Hieb 2 (Halbschlicht)
3381-3	Hieb 3 (Schlicht)

Rundfeile, 200 mm

Round File, 200 mm



Art.-Nr./Art.-No.	Typ/Model
3383-1	Hieb 1 (Bastard)
3383-2	Hieb 2 (Halbschlicht)
3383-3	Hieb 3 (Schlicht)

Dreikantfeile, 200 mm

Three Square File, 200 mm



Art.-Nr./Art.-No.	Typ/Model
3385-1	Hieb 1 (Bastard)
3385-2	Hieb 2 (Halbschlicht)
3385-3	Hieb 3 (Schlicht)

Halbrundfeile, 200 mm

Half Round File, 200 mm



Art.-Nr./Art.-No.	Typ/Model
3382-1	Hieb 1 (Bastard)
3382-2	Hieb 2 (Halbschlicht)
3382-3	Hieb 3 (Schlicht)

Vierkantfeile, 200 mm

Square File, 200 mm



Art.-Nr./Art.-No.	Typ/Model
3384-1	Hieb 1 (Bastard)
3384-2	Hieb 2 (Halbschlicht)
3384-3	Hieb 3 (Schlicht)

5-teiliger Satz in Rolltasche

5 Pieces Set in Pouch

5
tlg./pcs.



Flachfeile, Rundfeile, Dreikantfeile, Halbrundfeile, Vierkantfeile, Hieb 2

Flat File, Round File, Three Square File, Half Round File, Square File, Hieb 2

Art.-Nr./Art.-No.	
3380	Set 5-teilig
3380E	Rolltasche leer/empty pouch

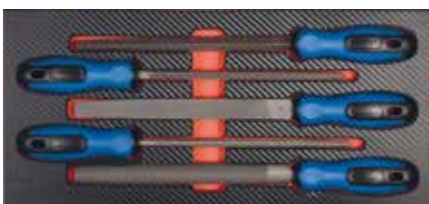

Weitere PROForm-Werkstatteinlagen ab Seite /
More PROForm Inlays for Roller Cabinet from Page H 32

Drahtbürsten

Wire Hand Brushes

Art.-Gruppe 181
Article Group 181

Stahl-Drahtbürste
glatt, Ø 0,30 – 0,35 mm,
vergüteter Stahldraht

Steel Wire Hand Brush
Straight Wire, Ø 0,30 – 0,35 mm,
Tempered Steel Wire



Art.-Nr./Art.-No.	Typ/Model
3375-2	2-Reihig/2 Rows
3375-3	3-Reihig/3 Rows
3375-4	4-Reihig/4 Rows
3375-5	5-Reihig/5 Rows

Messing-Drahtbürste
gewellt, Ø 0,25 – 0,30 mm

Brass Wire Hand Brush
Crimped, Ø 0,25 – 0,30 mm



Art.-Nr./Art.-No.	Typ/Model
3377-3	3-Reihig/3 Rows
3377-4	4-Reihig/4 Rows

V2A-Drahtbürste
gewellt, Ø 0,30 – 0,35 mm

Stainless Steel Wire Hand Brush
Crimped, Ø 0,30 – 0,35 mm



Art.-Nr./Art.-No.	Typ/Model
3376-3	3-Reihig/3 Rows
3376-4	4-Reihig/4 Rows

Zündkerzen-Bürste
gewellt, Messing-Draht,
Ø 0,15 mm

Spark Plug Hand Brush
Crimped, Brass Wire, Ø 0,15 mm



Art.-Nr./Art.-No.	Typ/Model
3379	3-Reihig/3 Rows

Feilen-Bürste
Nutzfläche ca. 115x40 mm

File Cleaner Hand Brush
Useable Surface ca. 115x40 mm

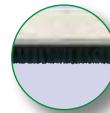

Art.-Nr./Art.-No.	Typ/Model
3378	115 x 40 mm

Messwerkzeuge

Measuring Tools

Art.-Gruppen 180/182
Article Groups 180/182

PROFESSIONAL PLUS STANDARD

Maßband

Measuring Tape



- ▶ Abnehmbarer Gürtelclip
- ▶ Bandfeststeller und automatischer Bandrücklauf
- ▶ Nach CE-Norm, Präzisionsklasse II

- ▶ Removable belt-clip
- ▶ Blade-lock and automatic-return
- ▶ According to CE-Norms, precision-class II

Art.-Nr./Art.-No.	Länge/Length
3963	3 m
3965	5 m
3968	7,5 m

PROFESSIONAL PLUS STANDARD

Maßband

Measuring Tape

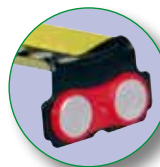

zusätzlich mit
starkem Magnet/
additional with
strong magnet



397312
Display mit/with 12x 3973



397512
Display mit/with 12x 3975

Art.-Nr./Art.-No.	Länge/Length
3973	3 m
397312	Display mit 12x 3973
3975	5 m
397512	Display mit 12x 3975

PROFESSIONAL PLUS STANDARD

Gliedermaßstab aus Kunststoff

Folding Plastic Ruler



Art.-Nr./Art.-No.	Länge/Length
3961	1 m

PROFESSIONAL PLUS STANDARD

Gliedermaßstab aus Holz

Folding Wooden Ruler



Art.-Nr./Art.-No.	Länge/Length
2978	EG-Klasse 3, 2 m

PROFESSIONAL PLUS STANDARD

Zimmermanns-Bleistift, ungespitzt, eckig-oval

Carpenter's Pencil,
Unsharpened, Square-Oval



Art.-Nr./Art.-No.	Länge/Length
2979	18 cm

Wasserwaagen

Water Levels

NEU/NEW

Art.-Gruppe 94
Article Group 94

PROFESSIONAL **PLUS** STANDARD

Aluminium-Wasserwaage mit Spiegel-Libelle

Aluminium Spirit Level with „Plumb Site Dual View“

- ▶ **Zwei festverbaute Libellen, darunter eine patentierte Vertikal-Spiegel-Libelle**
 - Einfaches frontales Ablesen der vertikalen Libelle auch an engen Stellen
 - Ergonomisches Arbeiten
 - ▶ **Toleranz: 0,5 mm/m (<0,0005 in/in)**
 - ▶ **1,5 mm Profilstärke**
 - Lange Lebensdauer
 - Genaue Messergebnisse auch bei großen Längen
 - ▶ **Stoßabsorbierende Endkappen**
 - Robustes Werkzeug
 - Verhindert Beschädigungen bei Herunterfallen
- ▶ *Two solid acrylic epoxy locked vials including one patented „Plumb Site Dual View“ vertical vial*
 - *Easy reading of the vertical vial even in narrow spaces*
 - *Ergonomic working*
 - ▶ *Tolerance: 0,5 mm/m (<0,0005 in/in)*
 - ▶ *1,5 mm profile strength*
 - *Long tool lifetime*
 - *Accurate results even with long lengths*
 - ▶ *Shock absorbing end caps*
 - *Robust tool*
 - *Prevents damage when falling*



NEU/NEW



Vertikal-Spiegel-Libelle
zum einfachen
frontalen Ablesen
„Plumb Site Dual View“
vertical vial for easy
reading

Einzel mit Aufhänger/Single Packaging with Hanger

Art.-Nr./Art.-No.	Länge/Length
2976-030	30 cm
2976-040	40 cm
2976-060	60 cm
2976-080	80 cm
2976-100	100 cm
2976-120	120 cm
2976-150	150 cm
2976-180	180 cm
2976-200	200 cm

Wasserwaagen

Water Levels

NEU/NEW

Art.-Gruppe 94
Article Group 94

PROFESSIONAL **PLUS** STANDARD

NEU/NEW

Aluminium-Wasserwaage mit Spiegel-Libelle und Magnet

Aluminium Spirit Level with „Plumb Site Dual View“ and Magnet

- ▶ **Zum Befestigen auf metallischen Oberflächen**
- ▶ **Einfaches Arbeiten, da die Wasserwaage von alleine hält**
- ▶ **Alle weiteren Details siehe „Aluminium-Wasserwaage mit Spiegel-Libelle“ auf Seite H 232**
- ▶ For fixing on metal surfaces
- ▶ Spirit Level adheres on its own for easy working
- ▶ Further details please refer to „Aluminium Spirit Level with Plumb Site Dual View“ on page H 232



Art.-Nr./Art.-No.	Länge/Length
2976-031	30 cm
2976-041	40 cm
2976-061	60 cm
2976-081	80 cm
2976-101	100 cm



PROFESSIONAL PLUS **STANDARD**

NEU/NEW

Aluminium-Wasserwaage

Aluminium Spirit Level

- ▶ **Zwei festverbaute UV-beständige Libellen zur Horizontal- und Vertikalmessung**
- ▶ **Toleranz: 0,5 mm/m (<0,0005 in/in) für genaue Messergebnisse**
- ▶ **1,0 mm Profilstärke**
- ▶ **Stoßabsorbierende Endkappen zur Verhinderung von Beschädigungen bei Herunterfallen**
- ▶ **In 8 unterschiedlichen Längen verfügbar**
- ▶ Two solid acrylic epoxy locked UV-protecting horizontal and vertical vials
- ▶ Tolerance: 0,5 mm/m (<0,0005 in/in) for accurate results
- ▶ 1,0 mm profile strength
- ▶ Shock absorbing end caps prevents damage when falling
- ▶ 8 different length available



Art.-Nr./Art.-No.	Länge/Length
2975-040	40 cm
2975-060	60 cm
2975-080	80 cm
2975-100	100 cm

Art.-Nr./Art.-No.	Länge/Length
2975-120	120 cm
2975-150	150 cm
2975-180	180 cm
2975-200	200 cm

Messwerkzeuge / Sonstige Werkzeuge

Measuring Tools / Other Tools

Art.-Gruppen 180/182
Article Groups 180/182

PROFESSIONAL PLUS STANDARD

Schlagschnur-Roller 30 m, Kunststoffgehäuse

Chalk Liner
30 m, Plastic Cover



Art.-Nr./Art.-No.	Länge/Length
2390	30 m

PROFESSIONAL PLUS STANDARD

Farbpulver für Schlagschnur-Roller

Powder for Chalk Liner



Art.-Nr./Art.-No.	Farbe/Color	Menge/Quantity
2393-1	Blau/Blue	100 g
2393-2	Rot/Red	100 g
2394-1	Blau/Blue	500 g
2394-2	Rot/Red	500 g

PROFESSIONAL PLUS STANDARD

Schieblehre aus rostfreiem Stahl, Schieber + Schiene matt verchromt, für Außen-, Innen- und Tiefenmessungen

Precision Vernier Caliper



Art.-Nr./Art.-No.	Messbereich/Range	Ablesung/Graduation
2970	0-150 mm/0-6"	1/20 mm 1/128"

PROFESSIONAL PLUS STANDARD

Knie- und Werkzeugunterlage 440 x 270 x 32 mm

Workpad 440 x 270 x 32 mm



Art.-Nr./Art.-No.	Größe/Size
398001	Knieunterlage 440 x 270 x 32 mm

PROFESSIONAL PLUS STANDARD

90° Bohr-Adapter

90° Drilling Adapter
Max. Drehmoment: 40 Nm
Max. torque: 40 Nm

NEU/NEW

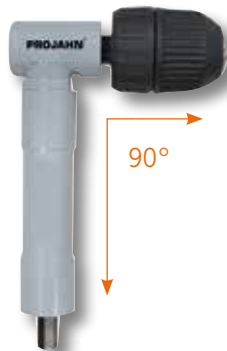

Schnellspannfutter
Quick Chuck

Art.-Nr./Art.-No.
398050

PROFESSIONAL PLUS STANDARD

90° Schraub-Adapter

90° Screwing Adapter
Max. Drehmoment: 40 Nm
Max. torque: 40 Nm

NEU/NEW



1/4" Bit-Aufnahme
1/4" Bit Shank

Art.-Nr./Art.-No.
398051

Messer und Sägen

Knives and Saws

Art.-Gruppe 180
Article Group 180

PROFESSIONAL PLUS STANDARD

3311

**Cutter Messer mit einziehbarer Klinge,
Klingenbreite: 18 mm**

*Utility Knife with Rectangular Blade,
Blade width: 18 mm*

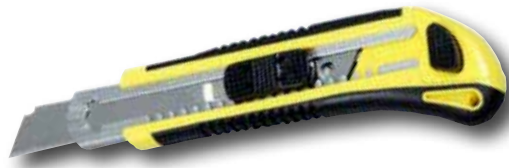

3311-1

10 Ersatzklingen für 3311
10 blades for 3311

331112

Display mit/with 12x 3311

Art.-Nr./Art.-No. Beschreibung/Description

3311 Cutter Messer, 18 mm

3311-1 10 Ersatzklingen für 3311

331112 Display mit 12x 3311

PROFESSIONAL PLUS STANDARD

3303

**10 Ersatzklingen
zu 3301 / 3306 / 3312**

10 Blades



Art.-Nr./Art.-No. Beschreibung/Description

3303 10 Ersatzklingen für 3301, 3306, 3312

PROFESSIONAL PLUS STANDARD

3312

SICHERHEITS-Cutter Messer mit Automatik-Klinge

► **Automatischer Klingeneinzug verhindert Verletzungen**

SECURITY Utility Knife with Automatic Blade

► *Automatic blade prevents physical injury*



331224

Display mit/with 24x 3312

Art.-Nr./Art.-No. Beschreibung/Description

3312 Cutter Messer, Automatik-Klinge

331224 Display mit 24x 3312

PROFESSIONAL PLUS STANDARD

3301

**Messer mit einziehbarer
Klinge und Schutzköcher**

*Knife with
Rectangular Blade*



Art.-Nr./Art.-No. Beschreibung/Description

3301 Cutter mit Köcher

PROFESSIONAL PLUS STANDARD

PROFESSIONAL PLUS STANDARD

3306

**Messer
mit einziehbarer Klinge**

*Knife with
Rectangular Blade*



Art.-Nr./Art.-No. Beschreibung/Description

3306 Messer mit einziehbarer Klinge

Messer und Sägen / Schaltschrankschlüssel

Knives and Saws / Control Cabinet Key

Art.-Gruppe 180
Article Group 180

PROFESSIONAL **PLUS** STANDARD

Metallsägebogen 300 mm

Hack Saw



Bi-Metall

- ▶ Mit verchromtem Vierkant-Stahlrohrbügel
- ▶ Ersatzsägeblätter/Single Blades (Art. 6530024)

Art.-Nr./Art.-No.	Beschreibung/Description
3305	Metallsägebogen/Hack Saw
6530024	Ersatzblätter/Single Blades

PROFESSIONAL **PLUS** STANDARD

Kleinhandsägebogen 260 mm

Mini Hack Saw 260 mm

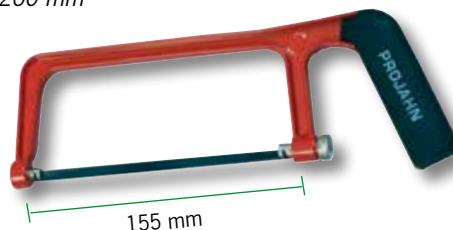

Art.-Nr./Art.-No.	Größe/Size
3304	Kleinhandsägebogen 260 mm
3304-1	Sägeblatt/Saw Blade 155 mm

PROFESSIONAL **PLUS** STANDARD

PUK Handsäge

PUK Hand Saw



Art.-Nr./Art.-No.	Beschreibung/Description	Nr.
3307	PUK Handsäge	Nr. 305
3307-1	Universal-Sägeblatt	Nr. 310
	10 Zähne pro cm / 10 teeth per cm	
	25 Zähne pro Zoll / 25 teeth per inch	
3307-2	Metall-Sägeblatt	Nr. 312
	12 Zähne pro cm / 12 teeth per cm	
	32 Zähne pro Zoll / 32 teeth per inch	

PROFESSIONAL **PLUS** STANDARD

Schraubenausdreher Satz

Screw Extractor Set

6
tlg./pcs.



Zum Ausdrehen von abgebrochenen Schrauben und Bolzen

To extract broken screws and nuts

Art.-Nr./Art.-No.	Nummer/no.	Größe/Size	Vorböhr-Ø/Size of drill
3059	Nr. 1	M3 - M6 (1/8" - 1/4")	1,8 mm
	Nr. 2	M6 - M8 (1/4" - 5/16")	3,2 mm
	Nr. 3	M8 - M11 (5/16" - 7/16")	4,5 mm
	Nr. 4	M11 - M14 (7/16" - 9/16")	6,5 mm
	Nr. 5	M14 - M18 (9/16" - 3/4")	8,5 mm
	Nr. 6	M18 - M24 (3/4" - 1")	12,0 mm

PROFESSIONAL **PLUS** STANDARD

TORX® Schraubenausdreher-Set, 18-teilig

TORX® Screw Extractor Set, 18 pieces



18
tlg./pcs.

Auch geeignet für Innensechskant-Antrieb

Also suitable for HEX drive

NEU/NEW

7	25 mm TORX®/TX (gelb/yellow)	T10 - 15 - 20 - 25 - 27 - 30 - 40
7	50 mm E-TORX® Schraubenausdreher Screw Extractor	TE10 - 15 - 20 - 25 - 27 - 30 - 40
2	38 mm E-TORX® Schraubenausdreher Screw Extractor	TE50 - 55
1	Bit-Adapter/Bit Adapter	1/4" - 10 mm
1	Magn. Bithalter/Magn. Bit Holder	1/4", 60 mm

Art.-Nr./Art.-No.	L./L.	B./W.	H./H.
398006	155	115	35

Schraubzwingen

Screw Clamps

Art.-Gruppe 181
Article Group 181

Temperguss Schraubzwinde nach DIN 5117 schwere verzinkte Spannarme, verzinkte Hohlprofil-Schiene mit 6-seitiger Riffelung

Screw clamps according to DIN 5117

arms of best malleable cast iron, zincered, double-profiled bar
with 6-sides grooved



Art.-Nr./Art.-No.	Größe/Size	Schiene/Bar
2941-0160	160 x 80 mm	25 x 6 mm
2941-0200	200 x 100 mm	30 x 8 mm
2941-0250	250 x 120 mm	30 x 8 mm
2941-0300	300 x 140 mm	35 x 9 mm
2941-0400	400 x 175 mm	35 x 9 mm
2941-0500	500 x 120 mm	35 x 11 mm
2941-0600	600 x 120 mm	35 x 11 mm
2941-0800	800 x 120 mm	35 x 11 mm
2941-1000	1000 x 120 mm	35 x 11 mm
2941-1250	1250 x 120 mm	35 x 11 mm

Ganzstahl Schraubzwinde Festbügel aus kaltgezogenem Profilstahl, Gleitbügel gesenkgeschmiedet

All-steel clamps

spring tempered profiled bar,
moveable arm drop-forged

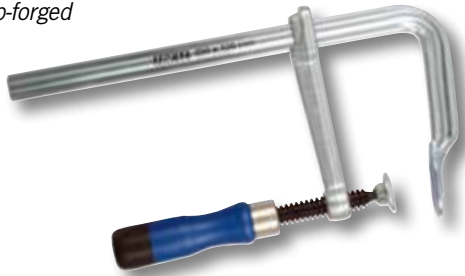

Art.-Nr./Art.-No.	Größe/Size	Schiene/Bar
2942-0160	160 x 80 mm	16,0 x 7,5 mm
2942-0200	200 x 100 mm	19,5 x 9,5 mm
2942-0250	250 x 120 mm	22,0 x 10,5 mm
2942-0300	300 x 140 mm	25,0 x 12,0 mm
2942-0400	400 x 120 mm	25,0 x 12,0 mm
2942-0500	500 x 120 mm	25,0 x 12,0 mm

Ganzstahl Hebelzwinde zum schnellen und mühelosen Spannen mit hohem Spanndruck mit selbstarretierendem spannhebelbetätigtem Rastzahnsegment

All-steel clamps with quick-lever handle



Art.-Nr./Art.-No.	Größe/Size	Schiene/Bar
2943-0160	160 x 80 mm	16,0 x 7,5 mm
2943-0250	250 x 120 mm	22,0 x 10,5 mm
2943-0400	400 x 120 mm	25,0 x 12,0 mm

Werkzeugkoffer

Tool Case

Art.-Gruppe 111
Article Group 111

4963

Werkzeug-Trolley

Tool Trolley



Abschließbare Bügelschlösser/
Lockable U-Locks



Einrastender Teleskopgriff/
Telescopic Snap-Handle



Robuste Rollen/
Robust Castors



Haltbare Scharniere/
Hard-Wearing Hinges



Stabile Füße/
Solid Feet



Art.-Nr./Art.-No.	L./L.	B./W.	H./H.	tlg./pcs.	
4963	390	450	170	1	Werkzeug-Trolley leer/empty tool trolley

8681K

Werkzeugkoffer

Tool Case



Art.-Nr./Art.-No.	L./L.	B./W.	H./H.	tlg./pcs.	
8681K	460	330	145	1	Werkzeugkoffer leer/empty tool case
8682K	425	280	130	1	Werkzeugkoffer leer/empty tool case
8683K	460	330	145	1	Werkzeugkoffer leer/empty tool case
8684K	460	330	145	1	Werkzeugkoffer leer/empty tool case
8685K	460	330	145	1	Werkzeugkoffer leer/empty tool case

8681-SCHLUESSEL Ersatzschlüssel (Set á 2 Stück) für 8681, 8682, 8683, 8684, 8685, 4963-01



**Alle Module aus dem Kapitel
SYSTEMWAND finden Sie unter:**

All System Wall Racks you find at:

www.projahn.de/qr/pos/systemwand



**Alle Produkte aus dem Kapitel
WERBEMITTEL finden Sie unter:**

All Give-Aways you find at:

www.projahn.de/qr/werbemittel

Allgemeine Geschäftsbedingungen der PROJAHN Präzisionswerkzeuge GmbH

Gültig seit 1. April 2013. Hiermit verlieren alle vorherigen AGB ihre Gültigkeit!

1. Allgemeines

- 1.1 Unsere Lieferungen, Leistungen und Angebote erfolgen ausschließlich auf Grund dieser Geschäftsbedingungen. Diese gelten somit auch für alle künftigen Geschäftsbeziehungen, auch wenn sie nicht nochmals ausdrücklich vereinbart werden. Spätestens mit der Entgegennahme der Ware oder Leistung gelten diese Bedingungen als angenommen. Gegenbestätigungen des Käufers unter Hinweis auf seine Geschäfts- bzw. Einkaufsbedingungen wird hiermit widersprochen.
- 1.2 Alle Vereinbarungen, die zwischen uns und dem Käufer zwecks Ausführung dieses Vertrages getroffen werden, sind schriftlich niederzulegen.

2. Erfüllungsort, Gefahrübergang, Versicherung

- 2.1 Erfüllungsort für Lieferung und Zahlung ist Erlitzbach.
- 2.2 Die Gefahr geht auf den Käufer über, sobald die Sendung, an die den Transport ausführende Person, übergeben worden ist oder zwecks Versendung unser Lager verlassen hat. Wird der Versand auf Wunsch des Käufers verzögert, geht die Gefahr mit der Meldung der Versandbereitschaft auf ihn über.

3. Angebote und Preise

- 3.1 Die Darstellung unserer Waren im Internet oder im Katalog beinhaltet kein bindendes Angebot. Es handelt sich um eine Aufforderung an unsere Kunden, uns ein verbindliches Angebot zu unterbreiten.
- 3.2 Die Bestellung unseres Kunden stellt ein verbindliches Angebot auf Abschluss eines Kaufvertrages über die bestellte Ware dar. Soweit wir den Zugang der Bestellung bestätigen, stellt dies keine verbindliche Annahme der Bestellung dar.
- 3.3 Der Kaufvertrag kommt erst zu Stande, wenn wir dem Käufer eine verbindliche Auftragsbestätigung übermitteln oder die bestellte Ware an ihn versenden.
- 3.4 Wenn wir ein Angebot unterbreiten, ist dieses freibleibend und unverbindlich. Annahmeerklärungen und sämtliche Bestellungen bedürfen zur Rechtswirksamkeit unserer schriftlichen oder fernschriftlichen Bestätigung.
- 3.5 Sowohl Preisänderungen, als auch technische Änderungen bleiben uns vorbehalten. Unsere Produktabbildungen im Katalog und im Internet sind unverbindlich. Des weiteren wird jegliche Haftung für Druckfehler ausgeschlossen.
- 3.6 Es gilt jeweils die am Tage der Bestellung gültige Preisliste.
- 3.7 Die Preise verstehen sich zuzüglich der jeweiligen gesetzlichen Umsatzsteuer.
- 3.8 Im Katalog sind zu den jeweiligen Produkten die entsprechenden Verpackungseinheiten genannt. Die Verpackungseinheiten verstehen sich als Mindestabnahmemenge. Im Falle einer Minderbestellung erhöhen wir diese automatisch auf die entsprechende Verpackungseinheit. Diese Vorgehensweise bedarf nicht der ausdrücklichen Zustimmung des Bestellers.

4. Versandkosten

Sind keine abweichenden Vereinbarungen getroffen, gilt folgendes:

- 4.1 Unsere Preise verstehen sich „ab Werk“, ausschließlich Verpackung.
- 4.2 Ab Euro 250,- Nettom Auftragswert liefern wir innerhalb Deutschlands frei Haus, inklusive Verpackung.
- 4.3 Bei Inlandsaufträgen unter Euro 50,- Nettom Auftragswert wird ein Mindermengenzuschlag von Euro 5,- berechnet.

5. Liefer- und Leistungszeit

- 5.1 Liefertermine oder -fristen, die verbindlich oder unverbindlich vereinbart werden können, bedürfen der Schriftform.
- 5.2 Liefer- und Leistungsverzögerungen auf Grund höherer Gewalt und auf Grund von Ereignissen, die uns die Lieferung nicht nur vorübergehend wesentlich erschweren oder unmöglich machen – hierzu gehören insbesondere Streik, Aussperrung, behördliche Anordnungen usw., auch wenn sie bei unserem Lieferanten oder deren Unterlieferanten eintreten – haben wir auch bei verbindlich vereinbarten Fristen und Terminen nicht zu vertreten. Sie berechtigen uns, die Lieferung bzw. Leistung um die Dauer der Behinderung, zuzüglich einer angemessenen Anlaufzeit, hinauszuschieben oder wegen des noch nicht erfüllten Teils ganz oder teilweise vom Vertrag zurückzutreten. Wenn die Behinderung länger als drei Monate dauert, ist der Käufer nach angemessener Nachfristsetzung berechtigt, hinsichtlich des noch nicht erfüllten Teils vom Vertrag zurückzutreten. Verlängert sich die Lieferzeit oder werden wir von unserer Verpflichtung frei, so kann der Käufer hieraus keine Schadensersatzansprüche herleiten. Auf die genannten Umstände können wir uns nur berufen, wenn wir den Käufer unverzüglich benachrichtigt haben.
- 5.3 Wir sind zu Teillieferungen und Teilleistungen jederzeit berechtigt, es sei denn die Teillieferung oder Teilleistung ist vom Käufer bei Vertragsschluss ausgeschlossen worden.
- 5.4 Die Einhaltung der Liefer- und Leistungsverpflichtungen unsererseits, setzt die rechtzeitige und ordnungsgemäße Erfüllung der Verpflichtungen des Käufers voraus.
- 5.5 Kommt der Käufer in Annahmeverzug, so sind wir berechtigt, Ersatz des uns entstehenden Schadens zu verlangen. Schadensersatz wegen Nichterfüllung können wir pauschaliert in Höhe von 15% des vereinbarten Kaufpreises verlangen, es sei denn, der Käufer beweist, dass unser Schaden geringer ist oder wir weisen nach, dass der Schaden höher ist.
- 5.6 Mit Eintritt des Annahmeverzugs geht die Gefahr der zufälligen Verschlechterung und des zufälligen Untergangs auf den Käufer über.

6. Sonderwerkzeuge

Wenn wir einen Auftrag für Sonderwerkzeuge annehmen und schriftlich bestätigen, sind wir berechtigt, die Lieferung um eine angemessene Stückzahl zu über- oder unterschreiten.

7. Gewährleistung, Mängelrügen

- 7.1 Die von uns gelieferte Ware ist unverzüglich nach dem Eintreffen am Bestimmungsort mit der Sorgfalt eines ordentlichen Kaufmanns zu untersuchen und zu behandeln. Unterbleibt die Untersuchung, haften wir nicht für Mängel der Ware. Dies gilt entsprechend, wenn später erkennbare Mängel nicht unverzüglich gerügt werden. Mängel sind uns schriftlich, spätestens innerhalb von 8 Tagen nach Warenerhalt, mitzuteilen.
- 7.2 Sachmängel liegen nur vor, wenn die Mängel zum Zeitpunkt der Übergabe vorhanden sind. Deshalb liegen keine Sachmängel vor, wenn die Beanstandungen auf ungeeignete oder unsachgemäße Verwendung unserer Werkzeuge, natürliche Abnutzung, fehlerhafte oder nachlässige Behandlung, sowohl übermäßige Beanspruchung und den Einsatz von ungeeigneten Betriebsmitteln, als auch chemische, elektrochemische oder elektrische Einflüsse zurückzuführen sind, soweit die Verwendbarkeit unter entsprechenden Sonderbedingungen nicht vereinbart war.

- 7.3 Liegen Sachmängel vor, steht uns das Wahlrecht zu, ob die Nacherfüllung durch Nachbesserung oder Nachlieferung erfolgt. Wir haben auch das Recht, eine entsprechende Gutschrift für den gelieferten Artikel zu erstellen.
- 7.4 Auf Sachmängel, die den Wert und die Tauglichkeit der Ware nur unerheblich mindern, kann der Käufer einen Rücktrittsanspruch nicht stützen.

8. Zahlungsbedingungen, Zahlungsverzug

- 8.1 Eine Zahlung gilt erst dann als erfolgt, wenn wir über den Betrag verfügen können. Im Falle von Schecks gilt die Zahlung erst als erfolgt, wenn der Scheck eingelöst wird.
- 8.2 Bei Zahlungen innerhalb von 8 Tagen ab Rechnungsdatum (Eingang Konto) gewähren wir 2% Skonto.
- 8.3 Wir sind berechtigt, trotz anders lautender Bestimmungen des Käufers, Zahlungen zunächst auf dessen ältere Schulden anzurechnen. Wir werden den Käufer über die Art der erfolgten Verrechnung informieren. Sind bereits Kosten und Zinsen entstanden, so sind wir berechtigt, die Zahlung zunächst auf die Kosten, dann auf die Zinsen und zuletzt auf die Hauptleistung anzurechnen.
- 8.4 Der Käufer gerät, ohne dass es einer gesonderten Mahnung bedarf, am 30. Tage nach Rechnungsdatum in Verzug. Bei Zahlungsverzug ist die offene Forderung mit 8% Prozentpunkten über dem jeweiligen Basiszinssatz zu verzinsen. Sie sind dann niedriger anzusetzen, wenn der Käufer eine geringere Belastung nachweist; der Nachweis eines höheren Schadens durch uns ist zulässig.
- 8.5 Der Käufer ist zur Aufrechnung, Zurückbehaltung oder Minderung, auch wenn Mängelrügen oder Gegenansprüche geltend gemacht werden, nur berechtigt, wenn wir ausdrücklich zustimmen oder wenn die Gegenansprüche rechtskräftig festgestellt worden oder unstreitig sind. Zur Zurückbehaltung ist der Käufer nur wegen Gegenansprüchen aus demselben Vertragsverhältnis berechtigt.

9. Eigentumsvorbehalt

- 9.1 Bis zur Erfüllung aller Forderungen (einschließlich sämtlicher Saldoforderungen aus Kontokorrent), die uns aus jedem Rechtsgrund gegen den Käufer jetzt oder künftig zustehen, bleibt die gelieferte Ware in unserem Eigentum.
- 9.2 Der Käufer ist berechtigt, die Vorbehaltsware im ordnungsgemäßen Geschäftsverkehr zu veräußern, solange er nicht in Verzug ist. Verpfändungen oder Sicherungsübereignungen sind unzulässig. Die aus dem Weiterverkauf oder einem sonstigen Rechtsgrund (Versicherung, unerlaubte Handlung) bezüglich der Vorbehaltsware entstehenden Forderungen (einschließlich sämtlicher Saldoforderungen aus Kontokorrent) tritt der Käufer bereits jetzt sicherungshalber in vollem Umfang an uns ab. Wir ermächtigen ihn widerruflich, die an uns abgetretenen Forderungen für dessen Rechnung im eigenen Namen einzuziehen. Diese Einziehungsermächtigung kann nur widerrufen werden, wenn der Käufer seinen Zahlungsverpflichtungen nicht ordnungsgemäß nachkommt.
- 9.3 Bei Zugriffen Dritter auf die Vorbehaltsware, insbesondere Pfändungen, wird der Käufer auf unser Eigentum hinweisen und uns unverzüglich benachrichtigen, damit wir unsere Eigentumsrechte durchsetzen können. Soweit der Dritte nicht in der Lage ist, uns die in diesem Zusammenhang entstehenden gerichtlichen oder außergerichtlichen Kosten zu erstatten, haftet hierfür der Käufer.

- 9.4 Bei vertragswidrigem Verhalten des Käufers – insbesondere Zahlungsverzug – sind wir berechtigt, vom Vertrag zurückzutreten und die Vorbehaltsware heraus zu verlangen.

10. Haftungsbeschränkung

- 10.1 Schadensersatzansprüche sind unabhängig von der Art der Pflichtverletzung, einschließlich unerlaubter Handlungen, ausgeschlossen, soweit nicht vorsätzliches oder grob fahrlässiges Handeln vorliegt.
- 10.2 Bei Verletzung wesentlicher Vertragspflichten haften wir für jede Fahrlässigkeit, jedoch nur bis zur Höhe des vorhersehbaren Schadens. Ansprüche auf entgangenen Gewinn, ersparte Aufwendungen, aus Schadensersatzansprüchen Dritter sowie auf sonstige mittelbare- und Folgeschäden können nicht verlangt werden, es sei denn, ein von uns garantiertes Beschaffenheitsmerkmal bezweckt gerade, den Käufer gegen solche Schäden abzusichern.
- 10.3 Die Haftungsbeschränkungen und -ausschlüsse in den Absätzen 10.1 und 10.2 gelten nicht für Ansprüche, die wegen arglistigen Verhaltens auf unserer Seite entstanden sind, sowie bei einer Haftung für garantierte Beschaffenheitsmerkmale, für Ansprüche nach dem Produkthaftungsgesetz sowie Schäden aus der Verletzung des Lebens, des Körpers oder der Gesundheit.
- 10.4 Soweit unsere Haftung ausgeschlossen oder beschränkt ist, gilt dies auch für unsere Angestellten, Arbeitnehmer, Vertreter und Erfüllungsgehilfen.

11. Datenschutz

Personen- und firmenbezogene Daten werden von uns gespeichert und verarbeitet, soweit dies zur Durchführung der Aufträge notwendig und nach dem Bundesdatenschutzgesetz zulässig ist.

12. Anwendbares Recht, Gerichtsstand, Teilnichtigkeit

- 12.1 Für die gesamten Rechtsbeziehungen zwischen uns und dem Käufer gilt das Recht der Bundesrepublik Deutschland. Die Bestimmungen des UN-Kaufrechts finden keine Anwendung.
- 12.2 Gerichtsstand für alle sich aus dem Vertragsverhältnis unmittelbar oder mittelbar ergebenden Streitigkeiten ist unser Hauptsitz. Wir haben das Recht, Ansprüche auch an einem anderen gesetzlichen Gerichtsstand geltend zu machen.
- 12.3 Sollte eine der vorstehenden Bestimmungen unwirksam sein, bleibt die Wirksamkeit der übrigen Bestimmungen unberührt und die betroffene Bestimmung ist durch eine wirksame Regelung zu ersetzen, die der unwirksamen Bestimmung wirtschaftlich am nächsten kommt.

General Terms and Conditions : PROJAHN Präzisionswerkzeuge GmbH

Valid since April 1, 2013. All foregoing general terms and conditions herewith lose their validity.

Please be advised that general terms and conditions below are a translation of the German general terms and conditions.

The German general terms and conditions are also valid for international business.

1. General

- 1.1 Our deliveries, services and offers are made exclusively on the basis of these terms and conditions, which will also apply to all future business relations even if they are not expressly agreed anew. These terms and conditions are considered agreed upon receipt of the goods or services at the latest. Counter-confirmations on the part of the purchaser with reference to the purchaser's own terms of business or purchase are hereby rejected.
- 1.2 All agreements made between the purchaser and ourselves for the purpose of performance of this contract must be recorded in writing.

2. Place of Performance, Passing of Risk, Insurance

- 2.1 The place of performance for delivery and payment is Dietzenbach.
- 2.2 The risk passes to the purchaser as soon as the consignment has been transferred to the person carrying out the transportation or as soon as it has left our warehouse for the purpose of dispatch. If the dispatch is delayed at the purchaser's request, the risk passes to the purchaser on notification that the consignment is ready for dispatch.

3. Offers and Prices

- 3.1 The presentation of our goods on the internet or in the catalogue does not constitute an offer to which we are bound. It is an invitation to our customers to make us a binding offer.
- 3.2 The order placed by our customer represents a binding offer to conclude a contract of sale relating to the ordered goods. Insofar as we acknowledge receipt of the order, this does not represent binding acceptance of the order.
- 3.3 The contract of sale is brought about only when we forward a binding order confirmation to the purchaser or send the ordered goods to the purchaser.
- 3.4 If we submit an offer, it is non-binding and without engagement. Declarations of acceptance and all orders require our confirmation by letter or by written telecommunication to attain legal validity.
- 3.5 We reserve the right to change prices and to make technical modifications. The images of our products in the catalogue and on the internet are not binding. Furthermore, no liability for printing errors is accepted.
- 3.6 The price list valid on the order date applies.
- 3.7 The prices are subject to VAT at the respective statutory rate.
- 3.8 The catalogue indicates the packaging units corresponding to the respective products. The packaging units are the minimum purchase quantity. If an order for a reduced quantity is placed, we increase the order automatically to the relevant packing unit. This procedure does not require the orderer's express consent.

4. Shipping Costs

- Unless agreed otherwise, the following applies:
- 4.1 Our prices are "ex works", excluding packaging.
 - 4.2 From a net order value of Euro 250.- upwards, we deliver free domicile within Germany, including packaging.
 - 4.3 A mark-up of Euro 5.00 is charged for orders from domestic customers with a net order value of less than Euro 50.-.

5. Delivery and Performance Time

- 5.1 Delivery dates or delivery periods, which may be agreed on a binding or non-binding basis, have to be stated in writing.
- 5.2 We cannot be held responsible for delays in delivery and performance due to force majeure and events which significantly impede or render delivery by us impossible, not merely on a temporary basis – including, in particular, strikes, lock-outs, official rulings etc., and inclusive of such events affecting our suppliers and sub-suppliers, even in case of bindingly agreed dates and deadlines. They entitle us to postpone delivery or performance for the duration of the hindrance plus a reasonable lead time, or to withdraw from the contract in whole or in part on account of the part not fulfilled. If the hindrance lasts longer than three months, the purchaser is entitled to withdraw from the unfulfilled part of the contract after having granted a reasonable extension of time. If the delivery period is prolonged or if we are released from our obligations, the purchaser cannot derive any claims for damages from this. We will only have the right to plead the aforementioned circumstances if we have notified the purchaser promptly.
- 5.3 We are entitled to make partial deliveries and render partial performance at any time unless the purchaser excluded partial delivery or partial performance when the contract was concluded.
- 5.4 The adherence to the delivery and performance duties on our part presupposes the punctual and orderly fulfilment of the purchaser's obligations.
- 5.5 If the purchaser defaults on acceptance, we are entitled to claim compensation for the damage or loss we incur. We are entitled to claim liquidated damages for non-fulfilment to the amount of 15% of the agreed purchase price unless the purchaser proves that the damage or loss we incurred is lower or we prove that the damage or loss is higher.
- 5.6 Upon default of acceptance the risk of accidental deterioration and accidental loss passes to the purchaser.

6. Special Tools

If we accept an order for special tools and confirm it in writing, we are entitled to deliver a reasonably higher or lower number of units.

7. Warranty, Notification of Defects

- 7.1 Immediately after the goods we deliver have arrived at their destination, they have to be inspected and handled with the due care and diligence of a prudent businessman. If the goods are not inspected, we cannot be held liable for any defects. This applies analogously if defects identifiable at a later stage are not promptly notified. We are to be notified of any defects in writing, at the latest within 8 days from receipt of the goods.

- 7.2 Defects of quality are constituted only if the defects exist at the time of delivery. Therefore defects of quality are not constituted if the complaints can be put down to unsuitable or improper use of our tools, natural wear, faulty or negligent handling, excessive workloads, the use of unsuitable operating resources, as well as chemical, electrochemical or electrical influences, insofar as the usability under corresponding special conditions was not agreed.
- 7.3 If defects of quality are constituted, we have the right to choose whether the supplementary performance takes the form of rectification or replacement. We also have the right to issue a commensurate credit note for the article supplied.
- 7.4 The buyer is not entitled to base a rescission claim on defects of quality which only insignificantly reduce the value or fitness for use of the goods.

8. Terms of Payment, Default in Payment

- 8.1 Payment will be deemed to have been made only when the sum is at our disposal. In the case of cheques, payment will be deemed to have been made only when the cheque has been cashed.
- 8.2 For payments within 8 days from the date of invoice (receipt on the account) we grant a 2 % discount.
- 8.3 We are entitled, notwithstanding any purchaser's stipulations to the contrary, to post payments first against the purchaser's older debts. We will inform the purchaser of the nature of this settlement. If costs and interest have accrued, we are entitled to post the payment first against the costs, then against the interest and finally against the principal debt.
- 8.4 The purchaser will be in default on the 30th day after the date of invoice, without a separate notice of default having to be served. In case of default in payment, the unsettled claim bears interest at the rate of 8 percentage points above the respective base rate. The interest is to be set at a lower rate if the purchaser provides evidence of a lower burden. It is admissible for us to produce evidence of higher loss.
- 8.5 The purchaser does not have the right to offset, retain or reduce payments, even in the event of complaints or counterclaims, unless we expressly agree to such or the counterclaims have been res judicata or are undisputed. The buyer has a right of retention only due to counterclaims under the same contractual relationship.

9. Reservation of Title

- 9.1 The goods supplied remain our property until settlement of all claims (including all current account balance claims) to which we are entitled from the purchaser on any legal grounds, now or in future.
- 9.2 The goods subject to retention of title may be sold by the purchaser in the ordinary course of business as long as the purchaser is not in default. Pledging or transfer of ownership by way of security is inadmissible. The claims (including all current account balance claims) accruing from the resale or on any other legal grounds (insurance, tort) with respect to the goods subject to retention of title are herewith assigned to us in their entirety by the buyer by way of security. We revocably authorize the purchaser to collect the claims assigned to us, for his account

and in his name. This authorization for collection can be revoked only if the purchaser does not duly fulfil his payment obligations.

- 9.3 If a third party attempts to seize the goods subject to retention of title, in particular in case of attachment, the purchaser will draw attention to our ownership and notify us without delay so that we are in a position to enforce our title. If the third party is not in a position to reimburse us for the court and out-of-court costs incurred in this connection, the purchaser will be liable for them.
- 9.4 In case of breach of contract by the purchaser – in particular, default in payment – we are entitled to withdraw from the contract and to demand the return of the goods.

10. Limitation of Liability

- 10.1 Claims for damages are excluded, irrespective of the nature of the breach of obligations, including tort, unless deliberate or grossly negligent acts are involved.
- 10.2 In case of breach of fundamental contractual obligations, we are liable for every act of negligence, but only to the extent of the foreseeable damage or loss. Claims for loss of profit, saved expenditure, third-party claims for damages, and other indirect and consequential damage cannot be made unless a quality feature we guarantee has the express purpose of protecting the purchaser from such damage or loss.
- 10.3 The limitations and exclusions of liability set forth in paragraphs 10.1 and 10.2 do not apply to claims arising as a result of fraudulent conduct on our part, nor to liability for guaranteed quality features, claims under product liability law or damage resulting from injury to life, body and health.
- 10.4 To the extent that our liability is excluded or limited, this also applies to our employees, representatives and persons we engage for fulfilling our obligations.

11. Protection of Data Privacy

We store and process personal and company-related data as far as is necessary for executing the orders and as far as is admissible under the German Federal Data Protection Act (BDSG).

12. Applicable Law, Legal Venue, Severability

- 12.1 All legal relations between the purchaser and ourselves are governed by the laws of the Federal Republic of Germany to the exclusion of the provisions of the United Nations Convention on Contracts for the International Sale of Goods.
- 12.2 The legal venue for all disputes arising directly or indirectly from the contractual relationship is our principal place of business. We have the right to also assert claims at another place of jurisdiction.
- 12.3. Should any one of the above provisions be inoperative, the validity of the other provisions will remain unaffected. The provision concerned is to be replaced by an operative one that most closely resembles the economic intent of the original provision.

Artikelnummern-Verzeichnis

Articlenumber List

Art.-Nr. / No.	Seite / Page	Art.-Nr. / No.	Seite / Page	Art.-Nr. / No.	Seite / Page	Art.-Nr. / No.	Seite / Page	Art.-Nr. / No.	Seite / Page
100035	H98	1702-10	H164	1760325-03	H167	201518	H101	2302	H222
100040	H98	1702-50	H164	1760330-03	H167	201519	H101	2303	H222
100045	H98	1703-03	H164	1760340-03	H167	202055	H101	2304	H222
100050	H98	1703-10	H164	1761001-03	H167	202065	H101	2305	H222
100055	H98	1711-03	H164	1761002-03	H167	202080	H101	2308	H222
100060	H98	1711-10	H164	1761003-03	H167	202100	H101	2310	H222
100070	H98	1711-50	H164	1761101-03	H167	203001	H101	231013	H143
100080	H98	1712-03	H164	1761102-03	H167	203002	H101	231317	H143
100090	H98	1712-10	H164	1761103-03	H167	203003	H101	2315	H222
100100	H98	1712-50	H164	1761202-03	H167	203004	H101	231719	H143
100110	H98	1713-03	H164	1761203-03	H167	204001	H101	231922	H143
100120	H98	1713-10	H164	1761205-03	H167	204002	H101	2319221	H143
100130	H98	1721-03	H164	1761310-03	H167	204003	H101	231924	H143
100140	H98	1722-03	H164	1761315-03	H167	204004	H101	2321	H222
100503	H98	1723-03	H164	1761320-03	H167	205010	H102	2324	H222
100504	H98	1724-03	H164	1761325-03	H167	205015	H102	232427	H143
100505	H98	1731-03	H165	1761330-03	H167	205020	H102	232430	H143
100506	H98	1731-10	H165	1761340-03	H167	205025	H102	2325	H222
100507	H98	1731-50	H165	1801-03	H164	205027	H102	2326	H222
100508	H98	1732-03	H165	1802-03	H164	205030	H102	232732	H143
100509	H98	1732-10	H165	1803-03	H164	205040	H102	233236	H143
100510	H98	1732-50	H165	1811-03	H164	205045	H102	2341	H222
100511	H98	1733-03	H165	1812-03	H164	205050	H102	2341-1	H222
101060	H98	1733-10	H165	1813-03	H164	205055	H102	2341-2	H222
101070	H98	1733-50	H165	1822-03	H164	2052	H68	2363	H222
101080	H98	1734-03	H165	1824-03	H164	205310	H102	2365	H222
101090	H98	1734-10	H165	1831-03	H165	205315	H102	2368	H222
101100	H98	1734-50	H165	1832-03	H165	205320	H102	2369	H222
101110	H98	1735-03	H165	1833-03	H165	205325	H102	2390	H234
101120	H98	1735-10	H165	1834-03	H165	205327	H102	2393-1	H234
101130	H98	1736-03	H165	1835-03	H165	205330	H102	2393-2	H234
101503	H98	1736-10	H165	1836-03	H165	205340	H102	2394-1	H234
101504	H98	1736-50	H165	1837-03	H165	205345	H102	2394-2	H234
101505	H98	1737-03	H165	1841-03	H165	205350	H102	2404	H141
101506	H98	1737-10	H165	1842-03	H165	205355	H102	2406	H141
101507	H98	1741-03	H165	1843-03	H165	206003	H102	240607	H139
101508	H98	1742-03	H165	200060	H101	206004	H102	2408	H141
101509	H98	1742-10	H165	200070	H101	206005	H102	240809	H139
101510	H98	1743-03	H165	200080	H101	206006	H102	2410	H141
101511	H98	1743-10	H165	200090	H101	206007	H102	241011	H139
102040	H98	1744-03	H165	200100	H101	206008	H102	241013	H139
102055	H98	1750001-03	H166	200110	H101	206010	H102	2412	H141
102065	H98	1750002-03	H166	200120	H101	207075	H102	241213	H139
103001	H98	1750003-03	H166	200130	H101	207076	H102	241317	H139
103002	H98	1750101-03	H166	200140	H101	207077	H102	241415	H139
103003	H98	1750102-03	H166	200150	H101	207150	H102	2415	H141
104001	H98	1750103-03	H166	200160	H101	207151	H102	241617	H139
104002	H98	1750202-03	H166	200170	H101	207152	H102	241618	H139
104003	H98	1750203-03	H166	200180	H101	207250	H102	241719	H139
105008	H98	1750204-03	H166	200190	H101	208001	H102	241819	H139
105009	H98	1750310-03	H166	200200	H101	210000	H102	242022	H139
105010	H98	1750315-03	H166	200210	H101	211214	H101	242123	H139
105015	H98	1750320-03	H166	200220	H101	2128	H172	242426	H139
105020	H98	1750325-03	H166	200230	H101	2128	H99	242427	H139
105025	H98	1750330-03	H166	200240	H101	2137	H192	242528	H139
105027	H98	1751-03	H165	200507	H101	2138	H192	243032	H139
105030	H98	1751001-03	H166	200509	H101	220004	H102	243641	H139
105040	H98	1751002-03	H166	200510	H101	220005	H102	2440810	H142
106002	H98	1751003-03	H166	200511	H101	220006	H102	2441113	H142
106003	H98	1751101-03	H166	200512	H101	220007	H102	2441416	H142
106004	H98	1751102-03	H166	200513	H101	220008	H102	2441719	H142
106005	H98	1751103-03	H166	200514	H101	220010	H102	250008	H138
106006	H98	1751202-03	H166	200515	H101	220011	H102	250010	H138
106007	H98	1751203-03	H166	200516	H101	220012	H102	250012	H138
106008	H98	1751204-03	H166	200517	H101	220014	H102	250013	H138
107050	H99	1751310-03	H166	201070	H101	220016	H102	250016	H138
107052	H99	1751315-03	H166	201080	H101	220018	H102	250017	H138
107100	H99	1751320-03	H166	201100	H101	220020	H102	250018	H138
107102	H99	1751325-03	H166	201110	H101	2203	H141	250019	H138
107140	H171	1751330-03	H166	201120	H101	2205	H141	2505	H135
107150	H99	1752-03	H165	201130	H101	2207	H141	2506	H135
108100	H99	1753-03	H165	201140	H101	220810	H141	250607	H139
108200	H99	1754-03	H165	201150	H101	220911	H141	25062	H136
109150	H99	1755-03	H165	201160	H101	2210	H141	25065	H138
110000	H99	1756-03	H165	201170	H101	221011	H141	2507	H135
11911-01	H163	1757-03	H165	201180	H101	221012	H141	25072	H136
11911-01	H184	1760001-03	H167	201190	H101	221214	H141	25075	H138
120004	H98	1760002-03	H167	201210	H101	221315	H141	2508	H135
120005	H98	1760003-03	H167	201220	H101	221417	H141	250809	H139
120006	H98	1760101-03	H167	201509	H101	2216	H149	25081	H137
120007	H98	1760102-03	H167	201510	H101	221618	H141	25082	H136
120008	H98	1760103-03	H167	201511	H101	22166	H149	25085	H138
120010	H98	1760202-03	H167	201512	H101	221719	H141	2509	H135
120011	H98	1760203-03	H167	201513	H101	2218	H150	25091	H137
1701-03	H164	1760205-03	H167	201514	H101	2218E	H150	25092	H136
1701-10	H164	1760310-03	H167	201515	H101	221922	H141	25095	H138
1701-50	H164	1760315-03	H167	201516	H101	222224	H141	2510	H135
1702-03	H164	1760320-03	H167	201517	H101	2301	H222	251008	H139

Artikelnummern-Verzeichnis

Articlenumber List

Art.-Nr. / No.	Seite / Page	Art.-Nr. / No.	Seite / Page	Art.-Nr. / No.	Seite / Page	Art.-Nr. / No.	Seite / Page	Art.-Nr. / No.	Seite / Page
25101	H137	253032	H139	2633	H160	2728-10	H161	2813-10	H158
251011	H139	25304	H140	2634	H160	2729	H160	2814	H158
251013	H139	25305	H138	2635	H160	2729-10	H161	2821	H159
25102	H136	2532	H135	2636	H160	2731	H160	2822	H159
25105	H138	25321	H137	2637	H160	2731-10	H161	2823	H159
2511	H135	25322	H136	2651	H170	2731-100	H161	2824	H159
25111	H137	25324	H140	2652	H170	2732	H160	2825	H159
25112	H136	25325	H138	2653	H170	2732-10	H161	2826	H159
25115	H138	25361	H135	2656	H170	2732-100	H161	2831	H160
2512	H135	25364	H140	2657	H170	2733	H160	2831-10	H161
25121	H137	253641	H139	2658	H170	2733-10	H161	2832	H160
251213	H139	25384	H140	2661	H170	2733-100	H161	2832-10	H161
25122	H136	25411	H135	2662	H170	2734	H160	2833	H160
25125	H138	25414	H140	2663	H170	2734-10	H161	2833-10	H161
2513	H135	254146	H139	2665	H170	2734-100	H161	2834	H160
25131	H137	25424	H140	2667	H170	2735	H160	2834-10	H161
251317	H139	25461	H135	2668	H170	2735-10	H161	2835	H160
25132	H136	25464	H140	2669	H170	2735-100	H161	2835-10	H161
25135	H138	254650	H139	2671	H170	2736	H160	2836	H160
2514	H135	25484	H140	2672	H170	2736-10	H161	2836-10	H161
25141	H137	25501	H135	2673	H170	2736-100	H161	2837	H160
251415	H139	25504	H140	2674	H170	2737	H160	2837-10	H161
25142	H136	25551	H135	2676	H162	2737-10	H161	2841	H162
25145	H138	25554	H140	2677	H162	2738	H160	2842	H162
2515	H135	25601	H135	2678	H162	2738-10	H161	2843	H162
25151	H137	25604	H140	2679	H162	2739	H160	2844	H162
25152	H136	2561	H137	2680	H162	2739-10	H161	2845	H162
25155	H138	2562	H137	2681	H162	2741	H162	2846	H162
2516	H135	2563	H137	2683	H162	2741-10	H162	2850	H171
25161	H137	2564	H137	2684	H162	2742	H162	2851	H161
251617	H139	2565	H137	2685	H162	2742-10	H162	2852	H161
25162	H136	25651	H135	2686	H162	2743	H162	2853	H161
25165	H138	25654	H140	2687	H162	2743-10	H162	2854	H161
2517	H135	2566	H137	2688	H162	2744	H162	2855	H161
25171	H137	2567	H137	2690	H170	2744-10	H162	2856	H161
251719	H139	2568	H137	2691	H170	2745	H162	2857	H161
25172	H136	2569	H137	2692	H170	2745-10	H162	2860	H171
25175	H138	2570	H137	2696	H162	2746	H162	2862	H171
2518	H135	25701	H135	2697	H162	2746-10	H162	2864	H171
25181	H137	2571	H137	2698	H162	2747	H161	2870	H171
251819	H139	2572	H137	2699	H162	2748	H161	2880	H171
25182	H136	2580	H147	2700	H172	2749	H161	2880	H184
2519	H135	2580E	H147	2700	H97	2750	H171	2881	H161
25191	H137	2588-08	H143	2700-10	H157	2751	H161	2882	H161
25192	H136	2588-09	H143	2701	H157	2752	H161	2883	H161
251922	H139	2588-10	H143	2701-10	H157	2753	H161	2884	H161
25195	H138	2588-11	H143	2701-100	H157	2754	H161	2885	H161
2520	H135	2588-12	H143	2702	H157	2755	H161	2886	H161
25201	H137	2588-13	H143	2702-10	H157	2756	H161	2887	H161
252022	H139	2588-14	H143	2702-100	H157	2757	H161	2890	H170
2521	H135	2588-15	H143	2703	H157	2758	H161	2891	H170
25211	H137	2588-16	H143	2703-10	H157	2760	H171	2892	H170
25212	H136	2588-17	H143	2703-100	H157	2760	H99	2893	H170
252123	H139	2588-18	H143	2704	H157	2761	H102	2894	H170
2522	H135	2588-19	H143	2704-10	H157	2761	H171	2895	H170
25221	H137	2588-20	H143	2706	H157	2764	H171	2901	H157
25222	H136	2588-21	H143	2706	H157	2765	H172	2902	H157
252224	H139	2588-22	H143	2707	H157	2766	H172	2903	H157
25225	H138	2588-23	H143	2707	H157	2767	H172	2911	H158
2523	H135	2588-24	H143	2708	H157	2769	H171	2912	H158
25232	H136	2588-25	H143	2708	H157	2770	H171	2913	H158
2524	H135	2588-26	H143	2710-10	H158	2771-10	H161	2921	H159
25241	H137	2588-27	H143	2711	H158	2772-10	H161	2922	H159
25242	H136	2588-28	H143	2711-10	H158	2774-10	H161	2923	H159
252426	H139	2588-29	H143	2711-100	H158	2775-10	H161	2924	H159
252427	H139	2588-30	H143	2712	H158	2777-10	H161	2925	H159
252430	H139	2588-32	H143	2712-10	H158	2778-10	H161	2926	H159
25244	H140	260001	H140	2712-100	H158	2780-10	H162	2931	H160
25245	H138	260002	H140	2713	H158	2781-10	H162	2932	H160
2525	H135	2601	H157	2713-10	H158	2782-10	H162	2933	H160
25252	H136	2602	H157	2713-100	H158	2783-10	H162	2934	H160
252528	H139	2603	H157	2714	H158	2784-10	H162	2935	H160
2526	H135	260607	H140	2714-10	H158	2785-10	H162	2936	H160
25262	H136	260809	H140	2721	H159	2786-10	H162	2937	H160
2527	H135	261011	H140	2721-10	H159	2787-10	H162	2941-0160	H237
25271	H137	2611	H158	2722	H159	2788-10	H162	2941-0200	H237
25272	H136	2612	H158	2722-10	H159	2801	H157	2941-0250	H237
252730	H139	261213	H140	2723	H159	2801-10	H157	2941-0300	H237
252732	H139	2613	H158	2723-10	H159	2802	H157	2941-0400	H237
25274	H140	261415	H140	2724	H159	2802-10	H157	2941-0500	H237
25275	H138	261617	H140	2724-10	H159	2803	H157	2941-0600	H237
2528	H135	261719	H140	2725	H159	2803-10	H157	2941-0800	H237
25282	H136	261819	H140	2725-10	H159	2804	H157	2941-1000	H237
2529	H135	262022	H140	2726	H159	2811	H158	2941-1250	H237
25292	H136	262123	H140	2726-10	H159	2811-10	H158	2942-0160	H237
2530	H135	262427	H140	2727	H159	2812	H158	2942-0200	H237
25301	H137	2631	H160	2727-10	H161	2812-10	H158	2942-0250	H237
25302	H136	2632	H160	2728	H160	2813	H158	2942-0300	H237

Artikelnummern-Verzeichnis

Articlenumber List

Art.-Nr. / No.	Seite / Page	Art.-Nr. / No.	Seite / Page	Art.-Nr. / No.	Seite / Page	Art.-Nr. / No.	Seite / Page	Art.-Nr. / No.	Seite / Page
2942-0400	H237	301019	H105	3046	H162	3098	H162	320018	H106
2942-0500	H237	301021	H105	3046	H163	3098	H163	320020	H106
2943-0160	H237	301022	H105	305010	H168	310000	H107	320022	H106
2943-0250	H237	3011-10	H158	305015	H168	3101-10	H157	320024	H106
2943-0400	H237	3012	H158	305020	H168	3102-10	H157	3201	H157
2950	H21	3012	H163	305025	H168	3103-10	H157	3202	H157
2951	H21	3012-10	H158	305027	H168	3111-10	H158	3203	H157
2961	H161	301208	H105	305030	H168	3112-10	H158	321010	H106
2962	H161	301209	H105	305040	H168	311214	H105	321012	H106
2963	H161	301210	H105	305045	H168	311215	H105	321014	H106
2964	H161	301211	H105	305050	H168	311217	H105	321016	H106
2970	H234	301212	H105	305055	H168	311219	H105	321018	H106
2975-040	H233	301213	H105	305060	H168	3113-10	H158	321020	H106
2975-060	H233	301214	H105	305070	H168	311516	H107	321022	H106
2975-080	H233	301215	H105	305310	H168	311516	H171	321024	H106
2975-100	H233	301216	H105	305315	H168	3130-10	H160	3211	H158
2975-120	H233	301217	H105	305320	H168	313001	H168	3212	H158
2975-150	H233	301218	H105	305325	H168	313002	H168	3213	H158
2975-180	H233	301219	H105	305327	H168	313003	H168	3221	H159
2975-200	H233	301220	H105	305330	H168	3131-10	H160	3222	H159
2976-030	H232	301221	H105	305340	H168	3132-10	H160	3223	H159
2976-031	H233	301222	H105	305345	H168	3133-10	H160	3224	H159
2976-040	H232	301223	H105	305350	H168	3134-10	H160	3225	H159
2976-041	H233	301224	H105	305355	H168	3135-10	H160	3226	H159
2976-060	H232	301226	H105	305360	H168	3136-10	H160	3228	H160
2976-061	H233	301227	H105	305370	H168	3137-10	H160	3229	H160
2976-080	H232	301228	H105	305620	H169	3138-10	H160	3231	H160
2976-081	H233	301230	H105	305625	H169	3139-10	H160	3232	H160
2976-100	H232	301232	H105	305627	H169	3140-10	H160	3233	H160
2976-101	H233	301234	H105	305630	H169	314001	H168	3234	H160
2976-120	H232	301236	H105	305640	H169	314002	H168	3235	H160
2976-150	H232	3013-10	H158	305645	H169	315015	H168	3236	H160
2976-180	H232	301511	H105	305650	H169	315020	H168	3237	H160
2976-200	H232	301512	H105	305655	H169	315025	H168	3238	H160
2978	H231	301513	H105	305660	H169	315027	H168	3239	H160
2979	H231	301514	H105	305670	H169	315030	H168	3241	H162
300008	H105	301515	H105	305720	H169	315040	H168	3242	H162
300009	H105	301516	H105	305725	H169	315045	H168	3243	H162
300010	H105	301517	H105	305727	H169	315050	H168	3247	H162
300011	H105	301518	H105	305730	H169	315055	H168	3248	H162
300012	H105	301519	H105	305740	H169	315060	H168	3249	H162
300013	H105	301520	H105	305745	H169	315620	H169	325015	H106
300014	H105	302055	H168	305750	H169	315625	H169	325020	H106
300015	H105	302065	H168	305755	H169	315627	H169	325025	H106
300016	H105	302080	H168	305760	H169	315630	H169	325027	H106
300017	H105	302100	H168	305770	H169	315640	H169	325030	H106
300018	H105	302120	H168	3059	H236	315645	H169	325040	H106
300019	H105	3030-10	H160	306004	H168	315650	H169	325045	H106
300020	H105	303001	H168	306005K	H168	315655	H169	325050	H106
300021	H105	303002	H168	306006	H168	315660	H169	325055	H106
300022	H105	303003	H168	306007	H168	315670	H169	325060	H106
300023	H105	303004	H168	306008	H168	315720	H169	325110	H106
300024	H105	3031	H160	306010	H168	315725	H169	325115	H106
300026	H105	3031	H163	306012	H168	315727	H169	325120	H106
300027	H105	3031-10	H160	306014	H168	315730	H169	325125	H106
300028	H105	3032	H160	306040	H169	315730	H169	325127	H106
300030	H105	3032	H163	306050	H169	315740	H169	325130	H106
300032	H105	3032-10	H160	306060	H169	315745	H169	325140	H106
300034	H105	3033	H160	306080	H169	315750	H169	325145	H106
300036	H105	3033	H163	3061	H78	315755	H169	325150	H106
3001-10	H157	3033-10	H160	306100	H169	315760	H169	325155	H106
3002	H157	3034	H160	306120	H169	315770	H169	325160	H106
3002	H163	3034	H163	307125	H107	316004	H168	326005	H106
3002-10	H157	3034-10	H160	307126	H107	316005	H168	326006	H106
3003-10	H157	3035	H160	307127	H107	316006	H168	326007	H106
300509	H105	3035	H163	307250	H107	316008	H168	326008	H106
300510	H105	3035-10	H160	307251	H107	3161	H170	326010	H106
300511	H105	3036	H160	307252	H107	3162	H170	326012	H106
300512	H105	3036	H163	3080	H121	3163	H170	326014	H106
300513	H105	3036-10	H160	308001	H107	3164	H170	326017	H106
300514	H105	3037-10	H160	3081	H121	3165	H170	326019	H106
300515	H105	3038-10	H160	3082	H121	3171	H170	326105	H106
300516	H105	3039-10	H160	3083	H121	3172	H170	326106	H106
300517	H105	3040-10	H160	308300	H107	3173	H170	326107	H106
300518	H105	304001	H168	3084	H121	3174	H170	326108	H106
300519	H105	304002	H168	3085	H123	3175	H170	326110	H106
300520	H105	304003	H168	3086	H121	3181	H170	326112	H106
300521	H105	304004	H168	3088	H124	3182	H170	326114	H106
300522	H105	3041	H162	3093	H162	3183	H170	326117	H106
301010	H105	3041	H163	3093	H163	3184	H170	326119	H106
301011	H105	3042	H162	3094	H162	3185	H170	327005	H106
301012	H105	3042	H163	3094	H163	3196	H228	327006	H106
301013	H105	3043	H162	3095	H162	3197	H228	327008	H106
301014	H105	3043	H163	3095	H163	320010	H106	327010	H106
301015	H105	3044	H162	3096	H162	320011	H106	327012	H106
301016	H105	3044	H163	3096	H163	320012	H106	327014	H106
301017	H105	3045	H162	3097	H162	320014	H106	327016	H106
301018	H105	3045	H163	3097	H163	320016	H106	327105	H106

Artikelnummern-Verzeichnis

Articlenumber List

Art.-Nr. / No.	Seite / Page	Art.-Nr. / No.	Seite / Page	Art.-Nr. / No.	Seite / Page	Art.-Nr. / No.	Seite / Page	Art.-Nr. / No.	Seite / Page
327106	H106	3406	H127	3500E	H130	3783-11	H171	382117	H119
327108	H106	3406F	H127	3500E	H131	3783-12	H171	382117-1	H119
327110	H106	3407	H127	3500E	H132	3783-13	H171	382119	H119
327112	H106	3407F	H127	3501	H132	3784-06	H171	382119-1	H119
327114	H106	3408	H127	3502	H131	3784-07	H171	382121	H119
327116	H106	340810	H129	3601	H198	3784-08	H171	382121-1	H119
3274	H160	3408F	H127	3601-1.5	H198	3784-1/4	H171	383216	H120
3275	H160	3409	H127	3601-10	H198	3784-10	H171	384010	H120
3301	H235	3409F	H127	3601-12	H198	3784-11	H171	384011	H120
3303	H235	3410	H127	3601-14	H198	3784-12	H171	384012	H120
3304	H236	341013	H129	3601-17	H198	3784-13	H171	384014	H120
3304-1	H236	3410F	H127	3601-19	H198	3784-15	H171	384016	H120
3305	H236	3411	H127	3601-2	H198	3784-16	H171	384018	H120
3306	H235	3411F	H127	3601-2.5	H198	3784-17	H171	384020	H120
3307	H236	3412	H127	3601-3	H198	3784-3/8	H171	384022	H120
3307-1	H236	341213	H129	3601-4	H198	3784-5/16	H171	384024	H120
3307-2	H236	3412F	H127	3601-5	H198	3784-55	H171	385020	H120
3311	H235	3413	H127	3601-6	H198	3784-91	H184	385025	H120
3311-1	H235	3413F	H127	3601-7	H198	3784-92	H184	385027	H120
331112	H235	3414	H127	3601-8	H198	3784-93	H184	385030	H120
3312	H235	341415	H129	3602	H198	3784-M10	H171	385040	H120
331224	H235	3414F	H127	3602-1.5	H198	3784-M12	H171	385045	H120
3350	H223	3415	H127	3602-10	H198	3784-M6	H171	385050	H120
3350-2	H223	3415F	H127	3602-12	H198	3784-M8	H171	385055	H120
3350-3	H223	3416	H127	3602-14	H198	3785-08	H171	385060	H120
3350-4	H223	341618	H129	3602-17	H198	3785-1/4	H171	385070	H120
3350-5	H223	3416F	H127	3602-2	H198	3785-10	H171	3851	H121
3350-6	H223	3417	H127	3602-2.5	H198	3785-3/8	H171	386004	H120
3350-8	H223	341719	H129	3602-3	H198	3785-5/16	H171	386005	H120
335010	H106	3417F	H127	3602-4	H198	3787	H181	386006	H120
335015	H106	3418	H127	3602-5	H198	3788	H180	386008	H120
335020	H106	3418F	H127	3602-6	H198	3789	H181	386010	H120
335025	H106	3419	H127	3602-7	H198	3790	H180	386012	H120
335027	H106	3419F	H127	3602-8	H198	380008	H119	386014	H120
335030	H106	3421	H127	3603	H200	380009	H119	386017	H120
335040	H106	3421F	H127	3604	H198	380010	H119	386019	H120
335045	H106	3422	H127	3607	H199	380011	H119	3861	H121
335050	H106	3422F	H127	3607-10	H199	380012	H119	387075	H120
335055	H106	3424	H127	3607-15	H199	380013	H119	387125	H120
335060	H106	3424F	H127	3607-20	H199	380014	H119	3901201	H64
335070	H106	3427	H127	3607-25	H199	380015	H119	3901202	H64
3355	H223	3427F	H127	3607-27	H199	380016	H119	3901203	H65
3355-2	H223	3430	H127	3607-30	H199	380017	H119	3901204	H66
3355-3	H223	3430F	H127	3607-40	H199	380018	H119	3901205	H71
3355-4	H223	3432	H127	3607-45	H199	380019	H119	39012900	H109
3355-5	H223	3432F	H127	3607-50	H199	380020	H119	39012900	H93
3355-6	H223	3434	H127	3613	H199	380021	H119	39012900-1	H109
3361	H222	3436	H127	3613-015	H199	380022	H119	39012900-1	H93
3362	H222	3438	H127	3613-020	H199	380023	H119	3901401	H60
3363	H222	34411	H127	3613-025	H199	380024	H119	3901402	H60
3370	H223	34461	H127	3613-030	H199	380025	H119	39014900	H100
3370-1	H223	34501	H127	3613-040	H199	380027	H119	39014900	H93
3370-2	H223	3463	H129	3613-050	H199	380028	H119	39014900-1	H100
3370-3	H223	3463	H134	3613-060	H199	380030	H119	39014900-1	H93
3371-1	H223	3465	H129	3613-070	H199	380032	H119	3903401	H67
3371-2	H223	3465	H134	3613-080	H199	381000	H120	3903801	H62
3375-2	H230	3466	H133	3613-100	H199	381008	H119	3903802	H63
3375-3	H230	3466-01	H133	3613-120	H199	381009	H119	3903803	H69
3375-4	H230	3466-02	H133	3613-140	H199	381010	H119	39038900	H104
3375-5	H230	348605	H169	3613-170	H199	381011	H119	39038900	H93
3376-3	H230	348606	H169	3613-190	H199	381012	H119	39038900-1	H104
3376-4	H230	348608	H169	36131	H199	381013	H119	39038900-1	H93
3377-3	H230	348610	H169	3617	H200	381014	H119	3904201	H70
3377-4	H230	348612	H169	3619	H198	381015	H119	39048201	H72
3378	H230	348614	H169	3690	H128	381016	H119	39048202	H73
3379	H230	348705	H169	3690	H134	381017	H119	3906	H128
3380	H229	348706	H169	3691	H128	381018	H119	3907	H128
3380E	H229	348708	H169	3692	H128	381019	H119	3908	H128
3381-1	H229	348710	H169	3693	H128	381020	H119	390813	H129
3381-2	H229	348712	H169	3694	H128	381021	H119	3909	H128
3381-3	H229	3493	H131	3701	H157	381022	H119	390915	H129
3382-1	H229	3494	H130	3702	H157	381023	H119	3910	H128
3382-2	H229	3494E	H130	3703	H157	381024	H119	391019	H129
3382-3	H229	3494E	H131	3711	H158	381025	H119	3911	H128
3383-1	H229	3494E	H132	3712	H158	381027	H119	3912	H128
3383-2	H229	3494E	H145	3713	H158	381028	H119	3913	H128
3383-3	H229	3496	H131	3731	H160	381030	H119	3914	H128
3384-1	H229	3497	H131	3732	H160	381032	H119	391410	H120
3384-2	H229	3498	H130	3733	H160	381214	H120	3914516	H129
3384-3	H229	3499	H130	3734	H160	381214	H171	3914516	H174
3385-1	H229	3499E	H130	3735	H160	381234	H120	3915	H128
3385-2	H229	3499E	H130	3736	H160	381238	H120	3916	H128
3385-3	H229	3499E	H131	3737	H160	381410	H120	391619	H129
3386-2	H229	3499E	H131	3750	H172	382017	H119	3917	H128
3387-1	H229	3499E	H132	3783-06	H171	382019	H119	3918	H128
3387-2	H229	3499E	H132	3783-07	H171	382021	H119	3919	H128
3387-3	H229	3499E	H146	3783-08	H171	382022	H119	3921	H128
3388-2	H229	3500	H130	3783-10	H171	382024	H119	3922	H128

Artikelnummern-Verzeichnis

Articlenumber List

Art.-Nr. / No.	Seite / Page	Art.-Nr. / No.	Seite / Page	Art.-Nr. / No.	Seite / Page	Art.-Nr. / No.	Seite / Page	Art.-Nr. / No.	Seite / Page
3924	H128	400360	H110	412010	H113	418022	H122	4228	H109
3927	H128	400380	H110	412011	H113	418024	H122	4228	H93
3930	H128	400410	H110	412012	H113	418027	H122	423000	H112
3932	H128	400460	H110	412013	H113	418030	H122	4231	H108
393216	H120	400500	H110	412014	H113	418108	H122	4232	H108
394072	H77	4008	H61	412015	H113	418110	H122	4233	H108
394073	H179	4009	H78	412016	H113	418113	H122	4234	H108
394074	H173	4016	H76	412017	H113	418115	H122	4235	H108
39407412	H173	4016-02	H103	412018	H113	418117	H122	4236	H108
394075	H173	4016-03	H103	412019	H113	418118	H122	4245	H102
39407512	H173	4016-10	H103	4121	H75	418119	H122	4245	H118
394087	H175	4016-11	H103	412100	H113	418121	H122	4245	H99
39408712	H175	4016-12	H103	4122-01	H187	418122	H122	4246	H107
394089	H175	4016-13	H103	412707	H113	418124	H122	4246	H110
39408912	H175	4016-14	H103	412715	H113	418130	H122	4246	H118
394240	H117	4016-15	H103	4129	H114	4182	H122	4247	H110
394240-1	H116	4016-16	H103	412920	H113	418217	H122	4247	H110
394240-1	H117	4016-17	H103	4130-05	H190	418219	H122	4247	H118
394240-1	H118	4016-19	H103	4130-06	H190	418221	H122	4248	H102
394241	H117	4017	H76	4130-07	H190	4190	H195	4248	H118
394241-1	H116	4018	H63	4130-08	H190	4190-01	H172	4248	H99
394241-1	H117	4027	H80	4130-09	H190	4190-03	H172	4249	H102
394242	H117	4028	H65	4130-10	H190	4190-06	H195	4249	H107
394242-1	H116	407100	H110	4130-15	H190	4190-07	H195	4249	H118
394242-1	H117	407200	H110	4130-20	H190	4190-08	H195	4250	H102
394243	H117	407400	H110	4130-25	H190	4190-10	H195	4250	H107
394243-1	H116	4078	H79	4130-27	H190	4190-11	H195	4250	H118
394243-1	H117	408000	H110	4130-30	H190	4190-12	H195	4251	H107
394260	H118	4085	H173	4130-40	H190	4190-13	H195	4251	H110
394270	H116	4090	H177	413010	H114	4190-14	H195	4251	H118
394271	H116	409006	H177	413011	H114	4192	H178	4252	H110
394272	H116	4091	H176	413012	H114	4192	H191	4252	H110
394273	H116	409124	H176	413013	H114	419212	H178	4252	H118
394901	H91	4092	H174	413014	H114	419212	H191	4259	H118
3961	H231	4093	H177	413015	H114	4193	H174	4288	H172
396202	H224	409306	H177	413016	H114	419312	H174	4288	H97
396205	H224	4094	H178	413017	H114	4200-1	H100	4289	H95
396212	H224	4095	H176	413018	H114	4200-1	H93	4290	H172
396213	H224	409512	H176	413019	H114	420000	H99	4290	H97
396221	H225	4097	H178	413021	H114	420000	H99	4294	H172
396222	H225	4100-00	H188	413022	H114	420000	H99	4294	H97
396223	H225	4100-01	H188	413024	H114	420000	H99	4295	H169
396224	H226	4100-02	H188	413027	H114	420001	H112	4295	H172
396297-01	H225	4100-03	H188	413030	H114	420011	H112	4295	H97
396297-01	H225	4101	H74	413032	H114	4201	H99	4297	H227
396297-01	H225	4102-02	H188	4131	H75	4202	H99	4297	H96
396297-05	H226	4109	H112	413100	H114	4203	H99	4297-1	H227
3963	H231	4110-00	H189	413116	H114	4204	H99	4297-1	H96
3965	H231	4110-01	H189	413121	H114	4208	H100	4297-10	H227
3968	H231	4110-02	H189	413712	H114	4208	H93	4297-10	H96
3973	H231	4110-03	H189	413725	H114	4210-1	H104	4297-2	H227
397312	H231	411004	H112	413812	H114	4210-1	H93	4297-2	H96
3975	H231	411005	H112	4150-08	H190	421000	H103	4297-3	H227
397512	H231	411006	H112	4150-10	H190	421000	H103	4297-3	H96
398001	H234	411007	H112	4150-15	H190	421000	H103	4298	H95
398006	H236	411008	H112	4150-20	H190	421000	H103	4298-1	H95
398050	H234	411009	H112	4150-25	H190	421000	H113	4299	H96
398051	H234	411010	H112	4150-27	H190	421001	H103	4330-130	H212
398210	H218	411011	H112	4150-30	H190	421001	H113	4331-120	H212
398211	H217	411012	H112	4150-40	H190	421011	H103	4332-130	H212
398212	H217	411013	H112	4170	H195	421011	H113	4333-120	H212
39821314D	H218	411045	H112	4170-10	H195	4211	H103	4334-110	H212
39821314D	H218	411055	H112	4170-2	H195	4212	H103	4383	H214
398213GB	H218	411081	H112	4170-25	H195	4213	H103	4383-A1	H209
398214GB	H218	4111	H74	4170-3	H195	4214	H103	4383-A11	H209
398215	H217	411100	H112	4170-4	H195	4218	H104	4383-A2	H209
398230	H219	411207	H112	4170-5	H195	4218	H93	4383-A21	H209
398231	H219	411255	H112	4170-6	H195	4220-1	H109	4383-A3	H209
398250	H220	411301	H112	4170-8	H195	4220-1	H93	4383-A31	H209
398251	H219	411302	H112	4180	H195	422000	H107	4383-J1	H209
398252	H220	411438	H112	4180-10	H195	422000	H107	4383-J11	H209
3993	H132	411603	H112	4180-15	H195	422000	H107	4383-J2	H209
3994	H132	411604	H112	4180-20	H195	422000	H108	4383-J21	H209
3999	H132	411605	H112	4180-25	H195	422000	H108	4383-J3	H209
400001	H110	411606	H112	4180-27	H195	422000	H108	4383-J31	H209
400001	H93	411608	H112	4180-30	H195	422000	H108	4402	H150
400001-1	H110	411610	H112	4180-40	H195	422000	H108	4402E	H150
400190	H110	411705	H112	4180-45	H195	422000	H108	4403	H151
400210	H110	411715	H112	4180-50	H195	422000	H108	4403E	H151
400220	H110	4119	H113	418008	H122	422000	H114	4405	H148
400230	H110	411915	H112	418010	H122	422001	H108	4405E	H148
400240	H110	4120-01	H187	418013	H122	422001	H114	4405E	H148
400260	H110	4120-02	H187	418015	H122	422011	H108	4407	H145
400270	H110	4120-03	H187	418016	H122	422011	H114	4407E	H145
400290	H110	4120-04	H187	418017	H122	4221	H107	4407E	H146
400300	H110	4120-05	H187	418018	H122	4222	H107	4408	H144
400320	H110	4120-06	H187	418019	H122	4223	H107	4408E	H144
400350	H110	412008	H113	418021	H122	4224	H108	4408E	H146

Artikelnummern-Verzeichnis

Articlenumber List

Art.-Nr. / No.	Seite / Page	Art.-Nr. / No.	Seite / Page	Art.-Nr. / No.	Seite / Page	Art.-Nr. / No.	Seite / Page	Art.-Nr. / No.	Seite / Page
4410	H145	4621-20006	H208	483412	H123	5211-2	H104	5914	H21
4410E	H145	4622	H196	485027	H123	5211-2	H96	5915	H21
4411	H149	4622-01	H187	487100	H123	5214	H104	5916	H21
4411E	H149	4622-180	H207	487200	H123	5214	H94	5917	H21
4421	H144	4623	H196	4901-50	H18	5215	H104	5918	H21
4422	H144	4623-160	H207	4901-501	H25	5215	H113	5919	H21
4436	H146	4624	H196	4901-502	H26	5215	H94	5920	H21
4437	H146	4625	H196	4901-511	H27	5215-1	H104	5921	H19
4438	H146	4625-200	H207	4901-521	H30	5215-1	H113	5922	H19
4441	H148	4626-200	H207	4901-522	H29	5215-1	H94	5953	H23
4442	H149	4627-160	H207	4901-523	H28	5220	H109	5953-011	H23
4451	H150	4628-250	H207	4901-541	H31	5220	H96	5953-021	H23
4452	H151	4629-160	H207	492619	H123	5220-1	H109	5953-065	H23
4462	H147	4629-210	H207	495027	H123	5220-1	H96	5953-082	H23
4463	H147	4630-08	H190	4963	H238	5221	H109	5953-101	H23
4464	H147	4630-10	H190	4963-01	H86	5221	H96	5953-131	H23
4466	H147	4630-15	H190	500000	H110	5221-1	H109	5954	H24
4468	H151	4630-180	H208	500000	H93	5221-1	H96	5954-001	H24
4516-250	H205	4630-20	H190	500360	H110	5221-2	H109	5954-002	H24
4517-300	H205	4630-25	H190	500380	H110	5221-2	H96	5954-003	H24
4550	H210	4630-27	H190	500410	H110	5224	H109	597019	H124
4551	H210	4630-30	H190	500460	H110	5224	H94	5995-001	H25
4552	H210	4630-40	H190	500500	H110	5225	H109	5995-002	H26
4553-14	H210	4631-200	H208	500540	H110	5225	H114	5995-011	H27
4553-18	H210	4640-230	H206	500550	H110	5225	H94	5995-021	H30
4553-24	H210	4640-260	H206	500580	H110	5225-1	H109	5995-022	H29
4553-30	H210	4643-180	H206	500600	H110	5225-1	H114	5995-023	H28
4553-36	H210	4643-210	H206	500630	H110	5225-1	H94	5995-141	H31
4554-14	H210	4680	H213	500650	H110	580024	H124	5996-001	H20
4554-18	H210	4681	H213	500670	H110	580027	H124	5996-002	H20
4554-24	H210	4683	H214	500700	H110	580030	H124	5996-003	H20
4554-30	H210	4683-A2	H209	500710	H110	580032	H124	5996-004	H20
4554-36	H210	4683-A21	H209	500750	H110	580033	H124	5996-005	H20
4555	H210	4683-J2	H209	500770	H110	580034	H124	5996-006	H20
4556-175	H211	4683-J21	H209	500800	H110	580036	H124	5996-007	H20
4556-250	H211	4690-02	H172	507200	H110	580038	H124	5996-008	H20
4557-150	H212	4690-02	H191	507400	H110	580041	H124	5996-009	H20
4557-340	H205	4691	H213	508000	H110	580046	H124	5996-010	H20
4557-430	H205	4692-06	H191	508560	H110	580050	H124	5996-011	H20
4557-550	H205	4692-07	H191	508560	H93	581000	H124	5996-012	H20
4559-340	H205	4692-08	H191	5100-01	H188	581034	H124	5996-013	H20
4559-430	H205	4711	H192	5100-02	H188	587019	H124	5996-014	H20
4559-550	H205	4714	H192	510000	H110	587200	H124	5996-015	H20
4559-650	H205	4721	H197	5105-00	H193	5901	H14	5996-016	H20
4561-205	H211	4722	H197	5105-01	H193	5901-101	H25	5996-017	H20
4561-245	H211	4723	H197	5105-02	H193	5901-102	H26	5996-018	H20
4562-225	H211	4724	H197	5105-1230	H193	5901-111	H27	5996-019	H20
4563-275	H211	4725	H197	5115-00	H193	5901-121	H30	5996-020	H20
4584	H210	4727	H197	5115-01	H193	5901-122	H29	5996-021	H20
4584	H214	480017	H123	5115-02	H193	5901-123	H28	5996-022	H20
4600-00	H188	480019	H123	5120-02	H187	5901-141	H31	5996-023	H20
4600-01	H188	480020	H123	5120-03	H187	5901-20	H14	5996-024	H20
4600-02	H188	480021	H123	5120-04	H187	5901-201	H25	5996-025	H20
4600-03	H188	480022	H123	5120-05	H187	5901-202	H26	5996-026	H20
4600-1230	H189	480023	H123	5125-01	H193	5901-211	H27	5996-027	H20
4600-1231	H189	480024	H123	5125-03	H193	5901-221	H30	5996-028	H20
4601-165	H203	480025	H123	5125-04	H193	5901-222	H29	5996-029	H20
4601-180	H203	480026	H123	5125-05	H193	5901-223	H28	5996-030	H20
4601-200	H203	480027	H123	5125-06	H193	5901-241	H31	5996-031	H20
4601-20006	H203	480028	H123	5190	H193	5901-50	H14	5996-032	H20
4602-01	H188	480029	H123	5195	H194	5901-511	H27	5996-033	H20
4602-02	H188	480030	H123	5199	H196	5901-521	H30	5996-034	H20
4602-180	H203	480032	H123	5200	H100	5901-522	H29	5996-035	H20
4603-145	H203	480033	H123	5200	H96	5901-523	H28	5996-036	H20
4603-160	H203	480034	H123	5200-1	H100	5901-541	H31	5996-037	H20
4604-180	H203	480035	H123	5200-1	H96	5901-551	H25	5996-038	H20
4605-170	H204	480036	H123	5201	H100	5901-552	H25	5996-039	H20
4605-200	H204	480038	H123	5201	H96	5902	H15	5996-040	H20
4606-200	H204	480041	H123	5201-1	H100	5902-01	H49	5996-041	H20
4607-160	H204	480046	H123	5201-1	H96	5902-02	H49	5996-042	H20
4608-250	H205	480050	H123	5201-2	H100	5902-20	H15	5996-043	H20
4609-175	H205	481000	H123	5201-2	H96	5902-201	H49	5996-044	H20
4609-240	H205	481017	H123	5204	H100	5902-202	H49	5996-045	H20
4609-300	H205	481018	H123	5204	H94	5902-50	H15	5996-046	H20
4609-400	H205	481019	H123	5205	H100	5902-501	H49	5996-047	H20
4610-00	H189	481021	H123	5205	H112	5902-502	H49	5996-048	H20
4610-01	H189	481022	H123	5205	H94	5907	H19	5996-049	H20
4610-02	H189	481024	H123	5205-1	H100	5907-20	H19	5996-050	H20
4610-03	H189	481027	H123	5205-1	H112	5907-50	H19	5996-051	H20
4618-250	H205	481029	H123	5205-1	H94	5908	H19	5996-052	H20
4620-01	H187	481030	H123	5210	H104	5908-20	H19	5996-053	H20
4620-02	H187	481032	H123	5210	H96	5908-50	H19	5996-054	H20
4620-03	H187	481036	H123	5210-1	H104	5909	H19	5996-055	H20
4620-04	H187	481041	H123	5210-1	H96	5910	H19	5996-056	H20
4620-05	H187	481046	H123	5211	H104	5911	H19	5996-057	H20
4621	H196	481050	H123	5211	H96	5912	H19	5996-058	H20
4621-180	H207	482619	H123	5211-1	H104	5912-10	H19	5996-059	H20
4621-200	H208	483410	H123	5211-1	H96	5913	H19	5996-060	H20

Artikelnummern-Verzeichnis

Articlenumber List

Art.-Nr. / No.	Seite / Page	Art.-Nr. / No.	Seite / Page	Art.-Nr. / No.	Seite / Page	Art.-Nr. / No.	Seite / Page	Art.-Nr. / No.	Seite / Page
5996-061	H20	5996-149	H20	5998-073	H20	5999-05E	H34	5999-53E	H36
5996-062	H20	5996-150	H20	5998-074	H20	5999-05E	H34	5999-551	H37
5996-063	H20	5997-001	H20	5998-075	H20	5999-061	H41	5999-55E	H37
5996-064	H20	5997-002	H20	5998-076	H20	5999-062	H40	6211	H224
5996-065	H20	5997-003	H20	5998-077	H20	5999-062E	H40	6214	H224
5996-066	H20	5997-011	H20	5998-078	H20	5999-064	H40	6215	H225
5996-067	H20	5997-012	H20	5998-079	H20	5999-064E	H40	6216	H225
5996-068	H20	5997-013	H20	5998-080	H20	5999-065	H40	6241	H228
5996-069	H20	5997-014	H20	5998-081	H20	5999-065E	H40	6241-1	H228
5996-070	H20	5997-015	H20	5998-082	H20	5999-06E	H41	6242	H228
5996-071	H20	5997-016	H20	5998-083	H20	5999-071	H41	6251	H228
5996-072	H20	5997-026	H17	5998-084	H20	5999-071E	H41	6252	H227
5996-073	H20	5997-027	H17	5998-085	H20	5999-072	H42	6253	H227
5996-074	H20	5997-028	H17	5998-086	H20	5999-072E	H42	6258	H228
5996-075	H20	5997-029	H17	5998-087	H20	5999-072E	H42	6261	H227
5996-076	H20	5998-001	H20	5998-088	H20	5999-073	H42	6261-01	H227
5996-077	H20	5998-001SPACE	H17	5998-089	H20	5999-074	H42	6263	H227
5996-078	H20	5998-002	H20	5998-090	H20	5999-074E	H42	6263-01	H227
5996-079	H20	5998-003	H20	5998-091	H20	5999-082	H45	6271	H226
5996-080	H20	5998-004	H20	5998-092	H20	5999-082E	H45	6271-10	H226
5996-081	H20	5998-005	H20	5998-093	H20	5999-091	H44	6271-12	H226
5996-082	H20	5998-006	H20	5998-094	H20	5999-092	H44	6271-14	H226
5996-083	H20	5998-007	H20	5998-095	H20	5999-09E	H44	6271-17	H226
5996-084	H20	5998-008	H20	5998-096	H20	5999-09E	H44	6271-20	H226
5996-085	H20	5998-009	H20	5998-097	H20	5999-101	H45	6271-24	H226
5996-086	H20	5998-010	H20	5998-098	H20	5999-10E	H45	6271-28	H226
5996-087	H20	5998-011	H20	5998-099	H20	5999-111	H35	6299-01	H224
5996-088	H20	5998-012	H20	5998-100	H20	5999-11E	H35	6299-01	H224
5996-089	H20	5998-013	H20	5998-101	H20	5999-121	H35	6299-01	H224
5996-090	H20	5998-014	H20	5998-102	H20	5999-12E	H35	6299-01	H224
5996-091	H20	5998-015	H20	5998-103	H20	5999-131	H35	6299-01	H224
5996-092	H20	5998-016	H20	5998-104	H20	5999-13E	H35	6299-02	H225
5996-093	H20	5998-017	H20	5998-105	H20	5999-141	H39	6299-05	H224
5996-094	H20	5998-018	H20	5998-106	H20	5999-14E	H39	6299-06	H225
5996-095	H20	5998-019	H20	5998-107	H20	5999-151	H39	6299-07	H224
5996-096	H20	5998-020	H20	5998-108	H20	5999-15E	H39	6299-07	H224
5996-097	H20	5998-021	H20	5998-109	H20	5999-161	H44	6299-07	H224
5996-098	H20	5998-022	H20	5998-110	H20	5999-16E	H44	6299-07	H224
5996-099	H20	5998-023	H20	5998-111	H20	5999-171	H48	6299-07	H224
5996-100	H20	5998-024	H20	5998-112	H20	5999-17E	H48	6530024	H236
5996-101	H20	5998-025	H20	5998-113	H20	5999-181	H47	7901-50	H16
5996-102	H20	5998-026	H20	5998-114	H20	5999-18E	H47	7901-501	H25
5996-103	H20	5998-027	H20	5998-115	H20	5999-191	H38	7901-502	H26
5996-104	H20	5998-028	H20	5998-116	H20	5999-19E	H38	7901-511	H27
5996-105	H20	5998-029	H20	5998-117	H20	5999-211	H50	7901-521	H30
5996-106	H20	5998-030	H20	5998-118	H20	5999-21E	H50	7901-522	H29
5996-107	H20	5998-031	H20	5998-119	H20	5999-221	H50	7901-523	H28
5996-108	H20	5998-032	H20	5998-120	H20	5999-22E	H50	7901-541	H31
5996-109	H20	5998-033	H20	5998-121	H20	5999-231	H50	8601	H77
5996-110	H20	5998-034	H20	5998-122	H20	5999-23E	H50	8604	H182
5996-111	H20	5998-035	H20	5998-123	H20	5999-321	H32	8605	H99
5996-112	H20	5998-036	H20	5998-124	H20	5999-32E	H32	8606	H183
5996-113	H20	5998-037	H20	5998-125	H20	5999-331	H48	8651	H79
5996-114	H20	5998-038	H20	5998-126	H20	5999-33E	H48	8652	H79
5996-115	H20	5998-039	H20	5998-127	H20	5999-341	H43	8653	H81
5996-116	H20	5998-040	H20	5998-128	H20	5999-34E	H43	8654	H81
5996-117	H20	5998-041	H20	5998-129	H20	5999-351	H43	8655	H82
5996-118	H20	5998-042	H20	5998-130	H20	5999-355	H43	8656	H82
5996-119	H20	5998-043	H20	5998-131	H20	5999-355E	H43	8661	H80
5996-120	H20	5998-044	H20	5998-132	H20	5999-35E	H43	8662	H80
5996-121	H20	5998-045	H20	5998-133	H20	5999-361	H47	8663	H83
5996-122	H20	5998-046	H20	5998-134	H20	5999-36E	H47	8664	H83
5996-123	H20	5998-047	H20	5998-135	H20	5999-371	H39	8681	H85
5996-124	H20	5998-048	H20	5998-136	H20	5999-37E	H39	8681-SCHLUESSEL	H238
5996-125	H20	5998-049	H20	5998-137	H20	5999-391	H48	8681K	H238
5996-126	H20	5998-050	H20	5998-138	H20	5999-392	H48	8682	H87
5996-127	H20	5998-051	H20	5998-139	H20	5999-393	H48	8682K	H238
5996-128	H20	5998-052	H20	5998-140	H20	5999-411	H33	8683	H89
5996-129	H20	5998-053	H20	5998-141	H20	5999-41E	H33	8683K	H238
5996-130	H20	5998-054	H20	5998-142	H20	5999-421	H37	8684	H88
5996-131	H20	5998-055	H20	5998-143	H20	5999-42E	H37	8684K	H238
5996-132	H20	5998-056	H20	5998-144	H20	5999-431	H38	8685	H90
5996-133	H20	5998-057	H20	5998-145	H20	5999-43E	H38	8685K	H238
5996-134	H20	5998-058	H20	5998-146	H20	5999-441	H37	8686	H91
5996-135	H20	5998-059	H20	5998-147	H20	5999-44E	H37	8687	H194
5996-136	H20	5998-060	H20	5998-148	H20	5999-451	H46	8688	H84
5996-137	H20	5998-061	H20	5998-149	H20	5999-45E	H46	9961	H145
5996-138	H20	5998-062	H20	5998-150	H20	5999-461	H45	9981	H130
5996-139	H20	5998-063	H20	5999-011	H32	5999-46E	H45	9985	H206
5996-140	H20	5998-064	H20	5999-01E	H32	5999-471	H46	9986	H226
5996-141	H20	5998-065	H20	5999-021	H33	5999-47E	H46	9988	H148
5996-142	H20	5998-066	H20	5999-02E	H33	5999-481	H41		
5996-143	H20	5998-067	H20	5999-031	H33	5999-48E	H41		
5996-144	H20	5998-068	H20	5999-03E	H33	5999-511	H36		
5996-145	H20	5998-069	H20	5999-041	H34	5999-51E	H36		
5996-146	H20	5998-070	H20	5999-04E	H34	5999-521	H36		
5996-147	H20	5998-071	H20	5999-051	H34	5999-52E	H36		
5996-148	H20	5998-072	H20	5999-052	H34	5999-531	H36		

Stichwortverzeichnis Handwerkzeuge deutsch

Index German

Artikel Seite

A

Abisolierzangen	204
Abisolierzangen VDE	207
ACR Bits 1/4"	156, 157, 158, 167
Adapter 1/2"	107
Adapter 1/4"	99
Adapter 3/4"	110
Adapter 3/8"	102
Adapter 1"	110
Adapter-Satz	118
Adapter für Ratschenschlüssel	128
Armaturen Zangenschlüssel	205
ASSY-Bits	170
Arbeitslampen	216, 219, 220

B

Beißzangen	206
Bestückte Werkstattwagen	25 - 31
Bestückungen zu Werkstattwagen	25 - 31
Bestückungen zu Werkzeugkoffern	49, 50
Bit Adapter	99, 102, 107, 171
Bit Display 1/4"	163, 184
Bit Halter	171, 172
Bit Knarre für 10 mm Bits	97, 169, 172
Bit Knarren	97, 172
Bit Ratsche 1/4"	97, 172
Bit Ratschenschlüssel	129, 174
Bit Sätze	154, 155, 173 - 183
Bit Schraubendreher 99, 172, 174, 178, 191	172
Bits	153 - 172
Bits, diamantbeschichtet	156, 166
Bits mit Farbmarkierung	164, 165
Blech-Locher	228
Blechscheren	210
Bolzenausdreher	236
Bolzenschneider	210
Breitmaul Gripzangen	211
Bremsschleppschlüssel	141
Bremsschleppschlüssel Sätze	149
Bügelsäge	236
Bürsten	230

C

Clutch Bits 1/4"	170
Cutter Messer	235

D

Diamant-Bits	166
Displays für Bits	163, 184
Dolphin Ringgabelschlüssel	138
Dolphin Ringgabelschlüssel-Sätze	147
Doppelgabelschlüssel	139
Doppelgabelschlüssel-Sätze	148, 149
Doppelmaulschlüssel	139
Doppelmaulschlüssel-Sätze	148, 149
Doppelring-Ratschenschlüssel	129, 133, 134
Doppelringsschlüssel	139
Doppelringsschlüssel-Sätze	150, 151
Drahtbürsten	230
Drehmomentschlüssel	115 - 118
Durchgangsnüsse 3/8"	103
Durchgangsverlängerung 3/8"	103
Durchschläge	223
Durchschraubknarren-Sätze	76

Artikel Seite

E

Eckrohrzangen	205, 206
Eindreh Bit für Haken 1/4"	170
Eindrehwerkz. für Stockschrauben 1/4"	171
Einlagen zu Werkstattwagen	32 - 48
Einmaulschlüssel	140
Elektriker Schraubendreher Schlitz	193
Elektronikzangen	212
Engländer	141

F

Farb-Bits	164, 165, 175 - 178
Farbpulver für Schlagschnur-Roller	234
Fäustel	222
Feilen	229
Feilen-Bürste	230
Flachmeißel	223
Flachzange	212
Flechter Zangen	206
Flexible Ratschenschlüssel	127, 131
Flexible Verlängerung 1/4"	99
Fräsen	226

G

Gabelringsschlüssel	135 - 138
Gabelringsschlüssel-Sätze	144 - 147
Ganzstahl-Schraubzwingen	237
GearTech Ratschenschlüssel	127 - 134
Gemischte Stecknuss-Sätze	69 - 83
Gemischte Steckschlüsselkoffer	69 - 83
Gerüstbauerschlüssel	143
Gliedermaßstab	231
Gleitgriff 1/2"	107
Gleitgriff 1/4"	99
Gleitgriff 3/8"	113
Gleitgriff Adapter 1/2"	107
Gleitgriff Adapter 3/8"	102
Gleitgriff Adapter 1"	110
Gripzangen	211

H

Hämmer	222
Handfäustel	222
Hebelzwinde	237

I

Inbus Bits 1/4"	162, 165
Inbus Bits 10 mm	169
Inbus Bits 5/16"	168
Inbus Bits mit Bohrung 1/4"	162
Inbus-Bit-Schlag-Stecknüsse 1/2"	120
Inbus-Bit-Stecknüsse 1/2"	106
Inbus-Bit-Stecknüsse 1/4"	98
Inbus-Bit-Stecknüsse 3/8"	102
Inbus Schraubendreher	195
Inbus Stiftschlüssel	198 - 200
Innensechskant Bits 1/4"	162 - 165
Innensechskant Bits 10 mm	169
Innensechskant Bits 5/16"	168
Innensechskant Bits mit Bohrung 1/4"	162
Innensechskant-Bit-Stecknüsse 1/2"	106
Innensechskant-Bit-Stecknüsse 1/4"	98
Innensechskant-Bit-Stecknüsse 3/8"	102
Innensechskant Schraubendreher	195
Innensechskant Stiftschlüssel	198 - 200

Artikel Seite

K

Kantenzangen	206
Kardangeln 1"	110
Kardangeln 1/2"	107
Kardangeln 1/4"	99
Kardangeln 3/8"	102
Keilzahn Bits 1/4"	170
Kettenzange	212
Klemmzange	212
Klingen für Messer	235
Knarre 1"	93, 11
Knarre 1/2"	93 - 96, 109
Knarre 1/4"	93 - 97, 102
Knarre 3/4"	93, 110
Knarre 3/8"	93 - 96, 104
Kniekissen, Knieauflage	234
Kombizangen	203, 213
Kombizangen VDE	207, 208, 213
Körner	223
Kreuzmeißel	223
Kreuzschlitz Bits 1/4"	157, 158, 164, 166, 167
Kreuzschlitz Bits 5/16"	168
Kreuzschlitz-Bit-Stecknüsse 1/4"	98, 99
Kreuzschlitz-Bit-Stecknüsse 3/8"	101, 102
Kreuzschlitz Schraubendreher 188, 189, 196, 197	197
Kreuzschlitz Schraubendreher VDE	193, 194
Kugelkopf Bits 1/4"	162
Kugelkopf Schraubendreher	195
Kugelkopf Stiftschlüssel	198 - 200
Kunststoffhammer	222
Kunststoff-Rohrschere	227

L

Langbeck Klemmzange	212
Lange Gabelringsschlüssel	137
Lange Gabelringsschlüssel Sätze	146
Latthammer	222
LED-Taschenlampe	216 - 219
LED-Arbeitslampen	219, 220

M

Magnetheber	228
Magnetische Stecknuss Bits 1/4"	171
Magnetische Stecknusschienen 1/2"	114
Magnetische Stecknusschienen 1/4"	112
Magnetische Stecknusschienen 3/8"	113
Magnetschalen	21
Maßbänder	231
Maßstab	231
Mattenschneider	210
Meißel	223
Messer	235
Messing-Drahtbürste	230
MultiFit Steckschlüsselkoffer 1/4"	77
Multifunktions-Zangen VDE	208

N

O

Offene Doppelringsschlüssel	141
Offene Doppelringsschlüssel Sätze	149, 150

Artikel Seite

P

Pfeifenkopfschlüssel	143
Phasenprüfer	192, 193
Phillips Bits 1/4"	157, 164, 166, 167
Phillips Bits 5/16"	168
Phillips Schraubendreher	188, 196, 197
Phillips Schraubendreher VDE	193, 194
Phillips-Bit-Stecknüsse 1/4"	98
Phillips-Bit-Stecknüsse 3/8"	101
Pozidriv Bits 1/4"	158, 164, 166, 167
Pozidriv Bits 5/16"	168
Pozidriv-Bit-Stecknüsse 1/4"	98
Pozidriv-Bit-Stecknüsse 3/8"	101
Pozidriv Schraubendreher	189, 196, 197
Pozidriv Schraubendreher VDE	193, 194
Präzisions Schraubendreher	192
proficraft Steckschlüsselkoffer	79 - 83
proficraft Steckschlüsselkoffer 1/4"	79
proficraft Werkzeugkoffer	82, 84 - 91
PROForm Einlagen	32 - 50
PROForm Box	23, 24
PUK Säge	236

Q

Quergriff Schraubendreher	195
---------------------------	-----

R

Radiozangen	204, 207
Raspeln	229
Ratsche 1"	93, 110
Ratsche 1/2"	93 - 96, 109
Ratsche 1/4"	93 - 97, 100
Ratsche 3/4"	93, 110
Ratsche 3/8"	93 - 96, 104
Ratschenschlüssel	127 - 129, 133, 134
Ratschenschlüssel-Sätze	130 - 134
Ratschengabelringsschlüssel	127, 128
Ringgabelschlüssel	135 - 138
Ringgabelschlüssel-Sätze	144 - 147
Ringmaulschlüssel	135 - 138
Ringmaulschlüssel-Sätze	144 - 147
Robertson Bits 1/4"	170
Rohrabschneider	224 - 226
Rohrentgrater	228
Rohrschere	227
Rohrsteckschlüssel	140
Rohrsteckschlüssel-Sätze	148
Rohrzangen	205, 206
Rollgabelschlüssel	141, 142
Rollgabelschlüssel-Sätze	151
Rollmeter	231
Rundzange	212

S

Sägebogen	236
Sägen	236
Sanitär-Schlüssel	227
Sanitär-Umsteckknarre	227
Sanitär-Werkzeuge	227
Sanitärkreuzschlüssel	227
Schieblehre	234
Schlag-Adapter	120, 123, 124
Schlag-Stecknüsse 1"	124
Schlag-Stecknüsse 3/4"	123
Schlag-Stecknüsse 1/2"	119 - 122
Schlag-Stecknüsse Xi-on 1/2"	122

Stichwortverzeichnis Handwerkzeuge deutsch

Index German

Artikel	Seite	Artikel	Seite	Artikel	Seite	Artikel	Seite
Schlag-Stecknüsse für Alu-Felgen	121, 122	Steckschlüsselkoffer 1"	68	TX mit Loch Bits 10 mm	169	Xi-on Steckschlüsselkoffer 1/4"	74, 75
Schlag-Verlängerungen	120, 123, 124	Steckschlüsselkoffer 1/2"	64 - 66, 80 - 83	TX mit Loch Bits 5/16"	168	Xi-on Steckschlüsselkoffer 3/8"	74
Schlagkardangeln	120, 123, 124	Steckschlüsselkoffer Xi-on 1/2"	75	TX mit Loch Schraubendreher	190		
Schlagschnur-Roller	234	Steckschlüsselkoffer 1/4"	60, 61, 79	TX Ratschenschlüssel	133		
Schlagwerkzeuge	222	Steckschlüsselkoffer Xi-on 1/4"	74, 75	TX Schlagnüsse 1/2"	120		
Schlitz Bits 1/4"	159, 164, 166, 167	Steckschlüsselkoffer 3/4"	67	TX Schraubendreher	190		
Schlitz Bits 5/16"	168	Steckschlüsselkoffer 3/8"	69	TX Schraubendreher Sätze	196, 197		
Schlitz Schraubendreher	187, 196, 197	Steckschlüsselkoffer Xi-on 3/8"	74	TX Schraubendreher mit Quergriff	195		
Schlitz Schraubendreher VDE	193, 194	Stemmeisen	222	TX Stecknüsse 1/2"	106		
Schlitz-Bit-Stecknüsse 1/4"	98	Stiftschlüssel	198 - 200	TX Stecknüsse 1/4"	98		
Schlitz-Bit-Stecknüsse 3/8"	101	Stufenschlüssel	227	TX Stecknüsse 3/8"	102		
Schlosserhammer	222			TX Stiftschlüssel	199		
Schraubenausdreher	236	T					
Schraubendreher	186 - 197	Taschenlampen	216 - 220	U			
Schraubendreher mit Wechselklinge VDE	194	Telefonzangen	204	Umschaltbare Ratschenschlüssel	128 - 134		
Schraubendreher-Sätze	196, 197	Telefonzangen VDE	207	Umschaltknarre 1"	93, 110		
Schraubzwingen	237	Teleskop-Magnetheber	228	Umschaltknarre 1/2"	93 - 96, 109		
Schweißer-Gripzangen	211	Temperguss-Schraubzwingen	237	Umschaltknarre 1/4"	93 - 97, 100		
Seegerring-Zangen	209, 214	T-Gleitgriff 3/4"	110	Umschaltknarre 3/4"	93, 110		
Seitenschneider	203	Tiefe Schlagstecknüsse 1"	124	Umschaltknarre 3/8"	93 - 96, 104		
Seitenschneider VDE	207	Tiefe Schlagstecknüsse 1/2"	119, 121	Universalgriff 1"	93, 110		
Sicherheits Bit Sätze	180 - 183	Tiefe Schlagstecknüsse Xi-on 1/2"	122	Universalschraubendreher PH/PZ	189		
Sicherheits Bits 1/4"	170	Tiefe Schlagstecknüsse 3/4"	123	Universalschraubendreher PH/PZ VDE	193		
Sicherheits-Messer	235	Tiefe Stecknüsse 1/2"	105				
Sicherungs-O-Ringe	120, 123, 124	Tiefe Stecknüsse 1/4"	98	V			
Sicherungsring-Zangen	209, 214	Tiefe Stecknüsse 3/8"	101	V2A-Drahtbürste	230		
Sicherungsstifte	120, 123, 124	Tiefe Steckschlüssel-Einsätze 1/2"	105	VDE Schraubendreher	193, 194		
SIT Bits 1/4"	170	Tiefe Steckschlüssel-Einsätze 1/4"	98	VDE Zangen	207, 208, 213		
Spanner Bits 1/4"	170	Tiefe Steckschlüssel-Einsätze 3/8"	101	Vergaser Schraubendreher	187, 188		
Spannungsprüfer	192	Torsion-Bits	156, 167	Verlängerung 1"	110		
Spitzmeißel	223	Torsion-Bit-Box	175	Verlängerung 1/2"	107		
Splintentreiber	223	Torq Bits 1/4"	170	Verlängerung 1/4"	99		
Stahl-Drahtbürste	230	TORX Bits 1/4"	160, 161, 165 - 167	Verlängerung 3/4"	110		
Standhahn-Mutter-Schlüssel	228	TORX Bits 10 mm	169	Verlängerung 3/8"	102		
Steckgriff 1/4"	99, 112	TORX Bits 5/16"	168	Vielzahn Bits 1/4"	170		
Stecknuss Bit Adapter	171	TORX Bit Stecknüsse 1/2"	106	Vielzahn Bits 10 mm	169		
Stecknuss Bits 1/4"	171	TORX Bit Stecknüsse 1/4"	98	Vielzahn Bits 5/16"	168		
Stecknüsse 1"	110	TORX Bit Stecknüsse 3/8"	102	Vielzahn-Bit-Stecknüsse 1/2"	106		
Stecknüsse 1/2"	105 - 108	TORX Doppelringschlüssel	133				
Stecknüsse Xi-on 1/2"	114	TORX Doppelringschlüssel Sätze	133	W			
Stecknüsse 1/4"	98 - 99	TORX mit Loch Bits 1/4"	161	Wasserhahnventil-Sitzfräser	226		
Stecknüsse Xi-on 1/4"	112	TORX mit Loch Bits 10 mm	169	Wasserpumpenzangen	205, 206, 213		
Stecknüsse 3/4"	110	TORX mit Loch Bits 5/16"	168	Wasserpumpenzangen VDE	207		
Stecknüsse 3/8"	101 - 103	TORX mit Loch Schraubendreher	190	Wasserwaagen	232, 233		
Stecknüsse Xi-on 3/8"	113	TORX Ratschenschlüssel	133	Wechselklingen-Schraubendreher VDE	194		
Stecknuss-Satz 1"	68	TORX Schlagnüsse 1/2"	120	Werkstattwagen	12 - 31		
Stecknuss-Sätze 1/2"	64 - 66, 80 - 83	TORX Schraubendreher	190	Werkstattwagen Zubehör	12 - 31, 49		
Stecknuss-Sätze Xi-on 1/2"	75	TORX Schraubendreher Sätze	196, 197	Werkzeugaufgabe	234		
Stecknuss-Sätze 1/4"	60 - 61, 79	TORX Schraubendr. mit Quergriff	195	Werkzeugkoffer	69, 71, 72, 84 - 91		
Stecknuss-Sätze Xi-on 1/4"	74, 75	TORX Stecknüsse 1/2"	106	Werkzeugkoffer für Werkstattwagen	15, 49, 50		
Stecknuss-Sätze 3/4"	67	TORX Stecknüsse 1/4"	98	Werkzeugmappe VDE	194		
Stecknuss-Sätze 3/8"	69	TORX Stecknüsse 3/8"	102	Werkzeugtasche	91		
Stecknuss-Sätze Xi-on 3/8"	74	TORX Stiftschlüssel	199	Werkzeugtrolley	86, 238		
Stecknusssschienen, magnetisch 1/2"	108, 114	Tri-Wing Bits 1/4"	170	Winkelstiftschlüssel	198 - 200		
Stecknusssschienen, magnetisch 1/4"	112	Trolley	86, 238				
Stecknusssschienen, magnetisch 3/8"	103, 113	TX Bits 1/4"	160, 161, 165 - 167	X			
Steckschlüssel-Schraubendreher	191, 195	TX Bits 10 mm	169	Xi-on Schlag-Stecknüsse 1/2"	122		
Steckschlüssel-Einsatz 1"	110	TX Bits 5/16"	168	Xi-on Stecknüsse 1/2"	114		
Steckschlüssel-Einsatz 1/2"	105 - 108	TX Bit Schlagnüsse 1/2"	120	Xi-on Stecknüsse 1/4"	112		
Steckschlüssel-Einsatz Xi-on 1/2"	114	TX Bit Stecknüsse 1/2"	106	Xi-on Stecknüsse 3/8"	113		
Steckschlüssel-Einsatz 1/4"	98, 99	TX Bit Stecknüsse 1/4"	98	Xi-on Steckschlüssel-Einsätze 1/2"	114		
Steckschlüssel-Einsatz Xi-on 1/4"	112	TX Bit Stecknüsse 3/8"	102	Xi-on Steckschlüssel-Einsätze 1/4"	112		
Steckschlüssel-Einsatz 3/4"	110	TX Doppelringschlüssel	133	Xi-on Steckschlüssel-Einsätze 3/8"	113		
Steckschlüssel-Einsatz 3/8"	101 - 103	TX Doppelringschlüssel Sätze	133	Xi-on Steckschlüsselkoffer 1/2"	75		
Steckschlüssel-Einsatz Xi-on 3/8"	113	TX mit Loch Bits 1/4"	161				

Stichwortverzeichnis Handwerkzeuge englisch

Index Hand Tools English

Article	Page
A	
accessories for roller cabinet	12 - 31, 49
ACR bits 1/4"	156, 157, 158, 167
adapter 1/2"	107
adapter 1/4"	99
adapter 3/4"	110
adapter 3/8"	102
adapter for ratchet wrenches	128
adjustable wrenches	141, 142
all steel clamps	237
Assy bits 1/4"	170

B	
ball point bits 1/4"	162
ball point hex keys	198 - 200
ball point screwdriver	195
basin wrench	228
bit adapter	99, 102, 107, 171
bit display 1/4"	163, 184
bit holder	171, 172
bit ratchet for 10 mm bits	97, 169, 172
bit ratchet wrench	129, 174
bit ratchets	97, 172
bit screwdriver	180, 182, 186
bit screwdriver 1/4"	99, 172, 74, 178, 191
bit sets	154, 155, 173 - 183
bits	153 - 172
blades for knives	235
bolt cutter	210
brass wire hand brush	230
brushes	230

C	
carpenters pencil	231
center punch	223
chalk liner	234
chisels	222, 223
circlip pliers	209
Clutch bits 1/4"	170
color bits	164, 165, 175 - 178
combination pliers	203, 213
combination wrench sets	144 - 147
combination wrenches	135 - 138
construction wrenches	143
chross-chisel	223
cutter knives	235

D	
dead-blow hammer	222
deep impact sockets 1/2"	119, 121
deep sockets 1/2"	105
deep sockets 1/4"	98
deep sockets 3/8"	101
diamond coated bits	166
displays for bits	163, 184
Dolphin combination wrenches	138
double box wrench sets	150, 151
double box wrenches	139
double open end wrench sets	148, 149
double open end wrenches	139
double ring ratchet wrenches	133, 134
double ring wrench sets	150, 151
double ring wrenches	139

E	
elbow pipe wrenches	205, 206
electronic pliers	218
end cutting nippers	206
extension bar 1"	110
extension bar 1/2"	107
extension bar 1/4"	99
extension bar 3/4"	110
extension bar 3/8"	102

F	
file cleaner	230
files	229
flare nut wrench sets	216, 217
flare nut wrenches	141
flat chisel	224
flexible extension bar 1/4"	99
flexible ratchet wrenches	127, 131
foldable wooden ruler	231

G	
GearTech ratchet wrenches	126 - 134
go-through extension bar 3/8"	103
go-through sockets 3/8"	103
go-through sockets sets	76
grip pliers	211, 212

H	
hack saw	236
hammer	222
hex bit socket 1/2"	106
hex bit sockets 1/4"	98
hex bit sockets 3/8"	102
hex bits 1/4"	162, 165
hex bits 10 mm	169
hex bits 5/16"	168
hex keys	198 - 200
hex screwdriver	195
hole punch	223
hook driver 1/4"	170

I	
impact adapter	120, 123, 124
impact extension bars	120, 123, 124
impact sockets 1"	124
impact sockets 1/2"	119 - 122
impact sockets 3/4"	131
impact universal joint	120, 123, 124
inch bits 1/4"	162
inch combination wrench sets	147
inch combination wrenches	137
inch hex keys	200
inch nut setter 1/4"	171
inch ratchet wrenches	133
inch sockets 1/2"	105
inch sockets 1/4"	98
inch sockets 3/8"	101
inlays for roller cabinets	32 - 48
inlays for tool boxes	49, 50
interchangeable screwdriver sets VDE	194

K	
knives	235

L	
LED lights	216 - 220
lights	216 - 220
long combination wrench sets	146
long combination wrenches	137
long nose pliers	204, 207

M	
machinist hammer	222
magnetic nut setter 1/4"	171
magnetic pick up tool	228
magnetic socket holders 1/2"	114
magnetic socket holders 1/4"	112
magnetic socket holders 3/8"	113
magnetic trays	21
measuring tapes	231
mesh cutter	210
milling cutter	226
MultiFit socket sets 1/4"	77
multifunctional pliers VDE	208

N	
nut setter 1/4"	171

O	
----------	--

P	
Phillips bits 1/4"	157, 164, 166, 167
Phillips bits 5/16"	168
Phillips screwdriver	188, 193, 194, 196, 197
Phillips bit sockets 1/4"	98
Phillips bit sockets 3/8"	101
pick up tool	228
pin for impact sockets	120, 123, 124
pin punches	223
pincers	206
pipe wrenches	205, 206
plastic tube cutter	227
plier wrench for fittings	205
pliers	202 - 214
pliers sets	213, 214
pointed chisel	223
Pozidriv bits 1/4"	158, 164, 166, 167
Pozidriv bits 5/16"	168
Pozidriv screwdriver	189, 193, 194, 196, 197
Pozidriv bit sockets 1/4"	98
Pozidriv bit sockets 3/8"	101
precision screwdriver	192
proficraft socket sets 1/4"	79 - 83
proficraft tool sets	82, 84 - 91
PROForm Box	23, 24
PROForm inlays	32 - 50
powder for chalk liner	234
PUK saw	236
punches	223

R	
rasp	229
ratchet handle 1"	93, 11
ratchet handle 1/2"	93 - 96, 109
ratchet handle 1/4"	93 - 97, 100
ratchet handle 3/4"	93, 110

Article		Page	
ratchet handle 3/8"	93 - 96, 104		
ratchet wrench sets	130 - 134		
ratchet wrenches	127 - 129, 133, 134		
reversible ratchet wrenches	128, 132 - 134		
ring for impact sockets	120, 123, 124		
Robertson bits 1/4"	170		
roller cabinet	12 - 31		
roofing hammer	222		
ruler	231		

S	
sanitary cross wrench	227
sanitary ratchet handle	227
sanitary tools	234 - 228
sanitary wrench	227
saws	236
screw clamps	237
screw extractor	236
screw tight tool for setting screws 1/4"	171
screwdriver	186 - 197
screwdriver sets	194 - 197
security bit sets	180 - 183
security bits 1/4"	170
security utility knife	235
self grip pliers	211, 212
side cutter	203, 207, 212, 213
single open end wrenches	140
SIT bits 1/4"	170
sliding t-handle 3/4"	110
sliding t-handle 1/2"	107
slotted bit sockets 1/4"	98
slotted bit sockets 3/8"	101
slotted bits 1/4"	159, 164, 166, 167
slotted bits 5/16"	168
slotted screwdriver	187, 193, 194, 196, 197
sockets 1"	110
sockets 1/2"	105 - 108
sockets Xi-on 1/2"	114
sockets 1/4"	98, 99
sockets Xi-on 1/4"	112
sockets 3/4"	110
sockets 3/8"	101 - 103
sockets Xi-on 3/8"	113
socket screwdriver	191, 195
Socket sets 1"	68
socket sets 1/2"	64 - 66, 80 - 83
socket sets Xi-on 1/2"	75
socket sets 1/4"	60 - 61, 79
socket sets Xi-on 1/4"	74 - 75
socket sets 3/4"	67
socket sets 3/8"	69
socket sets Xi-on 3/8"	74
Spanner bits 1/4"	170
spark plug hand brush	230
spark plug sockets	101, 105
spinner handle 1/4"	99, 112
spirit level	232, 233
spline bit sockets 1/2"	106
spline bits 1/4"	170
spline bits 10 mm	169
stainless steel wire hand brush	230
steel wire hand brush	230
stoning hammer	222

Stichwortverzeichnis Handwerkzeuge englisch

Index Hand Tools English

Article	Page	Article	Page	Article	Page	Article	Page
T							
tamper bits 1/4"	161, 162	TORX screwdriver	190	U			
tamper bits 5/16"	168	TORX screwdriver with T-handle	195	universal handle 1"	110		
tamper hex bits 1/4"	162	TORX sockets 1/2"	106	universal joint 1"	110		
tamper TORX bits 10 mm	169	TORX sockets 1/4"	98	universal joint 1/2"	107		
tamper TORX screwdriver	190	TORX sockets 3/8"	102	universal joint 1/4"	99		
tamper TORX bits 10 mm	169	tower pincers	206	universal joint 3/8"	102		
taper punches	223	Tri-Wing bits 1/4"	170	universal key	242		
telescopic pick up tool	228	trolley	191, 244	universal screwdriver PH/PZ	189		
T-handle screwdriver	195	tube cutter	224 - 227	universal screwdriver PH/PZ VDE	193		
through-hole open-socket wrenches	143	tube deburrer	228	utility knives	235		
tinmans shears	210	TX bit sockets 1/2"	106	V			
tool bags	91, 194	TX bit sockets 1/4"	98	VDE pliers	207, 208, 213		
tool cases	69, 71, 72, 84 - 91	TX bit sockets 3/8"	102	VDE screwdriver	193, 194		
tool chests	15, 49, 50	TX bits 1/4"	160, 161, 165 - 167	vernier caliper	234		
tool sets	69, 71, 72, 84 - 91	TX bits 10 mm	169	voltage tester	192, 193		
tool sets VDE	194	TX bits 5/16"	168	W			
tool trolley	86, 238	TX double ring wrench sets	133	water tap milling cutter	226		
torsions-bits	167, 175	TX double ring wrenches	133	waterpump pliers	205, 206, 213		
Torq bits 1/4"	170	TX hex keys	199	welding grip pliers	211		
torque wrenches	116 - 118	TX impact sockets 1/2"	120	wire hand brushes	230		
TORX Bits 1/4"	160, 161, 165 - 167	TX impact bit socket 1/2"	120	wire stripping pliers	204, 207		
TORX bits 10 mm	169	TX ratchet wrench	133	wood chisel	222		
TORX bits 5/16"	168	TX screwdriver	190	working lights	216, 219, 220		
TORX bit sockets 1/2"	106	TX screwdriver with T-handle	195	workpad	234		
TORX bit sockets 1/4"	98	TX sockets 1/2"	106	X			
TORX bit sockets 1/4"	98	TX sockets 1/4"	98	Xi-on impact sockets 1/2"	122		
TORX bit sockets 3/8"	102	TX sockets 3/8"	102	Xi-on sockets 1/2"	114		
TORX double ring wrench sets	133			Xi-on sockets 1/4"	112		
TORX double ring wrenches	133			Xi-on sockets 3/8"	113		
TORX impact sockets 1/2"	120			Xi-on socket sets 1/2"	75		
TORX impact bit socket 1/2"	120			Xi-on socket sets 1/4"	74, 75		
TORX ratchet wrench	141			Xi-on socket sets 3/8"	74		

Bestellmöglichkeiten bei PROJAHN

Ordering options at PROJAHN

Telefonisch

By Phone

+49 (0) 6074 / 69 666 - 66

nexmart

nexmart

National: Bei Rückfragen zu nexmart hilft Ihnen unser Serviceteam gerne weiter +49 (0) 6074 / 69 666 - 66
Weitere Informationen finden Sie auf Seite H 253
International: We only provide this service in Germany

E-Mail

E-Mail

National: verkauf@projahn.de
International: sales@projahn.de

Onlineshop

Online Shop

www.projahn.de

Fax

Fax

National: 0 800 / 22 44 888
International: +49 (0) 6074 / 69 666 - 99

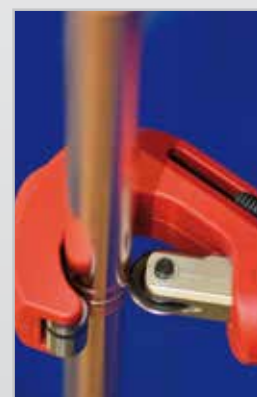

Professionelle Beratung
Flexibilität Customer Relationship Personal Support E-Commerce
Produkterschulungen Online-Competence
E-Commerce nexmart
Online-Kompetenz Delivery on Customer Request
Lieferung zum Wunschtermin E-Commerce
POS-Material **Sofortige Lieferung**
Immediate Delivery nexmart Beziehungsmanagement BME cat
Flexibility 24/7 Service
Individueller Marketingservice
Professional Support Immer erreichbar Customized Marketing Support
Product Training erreichbar POS-Material

nexmart – Einfach eBusiness*

nexmart – Simply eBusiness*

Bestellen rund um die Uhr:

nexmart

Das zentrale Branchennetzwerk mit über 230 Lieferanten und über 5 Millionen Artikeldaten bietet Ihnen online mehr Überblick in der Datenflut, tagesaktuelle Artikeldaten, reibungslose Bestellabwicklung und effiziente Prozesse – so sparen Sie Zeit und Kosten.

Informieren

Recherchieren Sie unsere Produkte und Artikeldaten, tagesaktuelle Preise und Verfügbarkeiten ganz bequem online:

- ▶ Zugriff auf unser gesamtes Katalogsortiment
- ▶ Sofortige Information zu Ihren individuellen Einkaufspreisen und der Artikelverfügbarkeit in Echtzeit
- ▶ Katalogdatenservice für Ihre Stammdatenpflege: alle Artikeldaten in verschiedenen Formaten (z.B. BMEcat) verfügbar

Bestellen

Bestellen Sie einfach und schnell direkt im Katalog, über die Warenkorb-Schnellbestellung oder mit direkter Anbindung Ihres Warenwirtschaftssystems:

Manuell

- ▶ Einfache Bedienung mit branchengerechten Funktionen
- ▶ Alle Artikel im Katalog mit Bestellbutton
- ▶ Schnelleingabe als Artikelliste direkt im Warenkorb möglich
- ▶ Direkte Information zu Preisen und Verfügbarkeit über Bestellanfrage

Elektronisch

- ▶ Direkte Anbindung ihres Warenwirtschaftssystems
- ▶ Automatische Übertragung aller Daten von und zu Ihrem Warenwirtschaftssystem
- ▶ Schnelle Bestellung ohne manuellen Aufwand
- ▶ Elektronische Rücknachrichten mit Auftragsbestätigung, Lieferavis und Rechnung im von Ihnen gewünschten Format
- ▶ Auswahl verschiedener Schnittstellen, Übertragungswege und Formate

Interessiert?

Sie möchten die Vorteile der Bestellung über nexmart nutzen? Das geht ganz einfach:

1. Beantragen Sie bei nexmart kostenfrei Ihre Kundennummer und Ihre Logindaten.
2. Lassen Sie sich über die Lieferantenseite den PROJAHN-Katalog freigeben.

Und schon können Sie bestellen!

Bei Rückfragen hilft Ihnen unser Serviceteam unter +49 (0) 6074 / 69 666 - 66 gerne weiter.

* PROJAHN bietet diesen Service innerhalb Deutschlands an.

* PROJAHN provides this service in Germany.

Ihr Fachhändler/*Your Retailer:*

201607HKATOP_DE

PROJAHN

Handwerkzeuge
Hand Tools